

Polet[®]

FORGED FOR LIFE SINCE

1865





KWALITEIT van generatie op generatie

Of u nu vaklui of hobbyisten over de vloer krijgt, u wil hen enkel kwaliteit aanbevelen. Zeker als het om gereedschap gaat. Want kwaliteit maakt hun werk aangenamer en efficiënter. Polet ontwikkelt al meer dan 150 jaar lang gereedschappen voor de professionele markt en de hobbymarkt. Leidraad doorheen al die jaren bleef steeds een verregaande specialisatie en streven naar innovatie. Het resultaat is een gelaagd productaanbod met een ruime commerciële en logistieke ondersteuning.

BELGISCH GEREEDSCHAP MET EUROPESE DIMENSIES.

Polet is een volledig Belgische onderneming. De kwaliteit van haar producten en dienstverlening overstijgt echter reeds lang de landsgrenzen. Ook in het buitenland kennen vaklui en tuinliefhebbers Polet immers als hun partner voor het zware werk.

EEN GELAAGD AANBOD VOOR COMMERCIEEL SUCCES.

Niet iedereen maakt even intensief gebruik van gereedschap of wil er hetzelfde bedrag in investeren. Het aanbod van Polet is volledig afgestemd op deze reële marktbehoeften. Polet-producten worden hoofdzakelijk verdeeld in de gespecialiseerde vakhandel, bouwmarkten en tuincentra. Deze kunnen rekenen op een ruime commerciële en logistieke ondersteuning.

VAN EENVOUDIGE SMIDSE TOT INDUSTRIËLE ONDERNEMING.

Meer dan 150 jaar geleden smeedde Polet reeds de eerste spadebladen. Van eenvoudige smidse groeide het bedrijf uit tot een industriële onderneming waar begrippen als kwaliteit en innovatie borg staan voor een gezonde commerciële ontwikkeling.

Polet-producten worden vervaardigd volgens internationale kwaliteitsnormen. Zowel tijdens als na de productie worden ze aan strenge testen onderworpen. Een innoverend productieproces resulteert in een hogere efficiëntie en bijgevolg in internationaal concurrentiële prijzen.

Productontwikkeling is bij Polet geen ijdél woord. Het is een zoektocht naar extra voordelen voor de gebruiker. Zo gaan de revolutionaire glasvezelstelen tot tienmaal langer mee. In alle sectoren wordt gewerkt met de gereedschappen van Polet: in de "groene" wereld van de tuinarbeid, op bouwerven of in industriële complexen.

Polet-kwaliteit leidt overal tot een hogere efficiëntie. Dat weet zowel de vakman als de hobbyist naar waarde te schatten.

WEBSITE & SOCIAL MEDIA



Website: www.polet.be

Bekijk ons assortiment tuingereedschappen en laatste nieuwtjes.



Facebook: www.facebook.com/Polet.Quality.Products

Volg ons op Facebook en blijf steeds op de hoogte.



Instagram: www.instagram.com/poletqualityproducts

Volg ons op Instagram voor inspiratie en beleving.



LinkedIn: www.linkedin.com/company/polet-quality-products

Kom meer te weten over ons bedrijf en volg ons nieuw aanbod.



Pinterest: www.pinterest.com/poletqualitypro

Laat je inspireren en bekijk onze tuintips.



YouTube: www.youtube.com/user/PoletQualityProducts

Ontdek de werkwijze van onze gereedschappen.



Like ons ook op
Facebook

ONS TEAM

BESTELLINGEN - TECHNISCHE INLICHTINGEN - INTERNE VERKOOP

Tel +32 53 62 22 05 - Fax +32 53 62 18 33

Orderverwerking: orderintake@polet.be

Boekhouding - facturatie - betalingen: accounting@polet.be

Algemene info - Klantendienst: info@polet.be · Frankrijk: info@outils-polet.fr

VERKOOP



STIJN TEMMERMAN
Sales & Export Director
+32 497 52 46 43
stijnt@polet.be



GEERT LANCKRIET
Merchandiser
+32 496 26 02 71
geertl@polet.be



ELKE VAN DAELE
Sales Assistant Backoffice
+32 53 62 22 05
elkevd@polet.be



EVELIEN DEJAEGHERE
Sales Assistant Backoffice
+32 51 74 43 82
eveliend@polet.be



RIA SANDERS
+32 496 26 02 70
rias@polet.be
Oost- en West-Vlaanderen
Antwerpen



PETER DIERICKX
+32 495 26 02 08
Key Accountmanager Nederland
peterd@polet.be
Nederland
Vlaams-Brabant - Limburg
Antwerpen/Kempen



CHLOË VANKEIRSBILCK
Sales Assistant Backoffice
+32 53 62 22 05
chloev@polet.be



JONAS VLEESCHOUWER
+32 497 42 03 89
jonasv@polet.be
Brussel - Henegouwen
Vlaams-Brabant - Waals-Brabant



CHRISTINE DODEMONT
+32 496 51 34 00
christined@polet.be
Namen - Luik - Luxemburg
Groothertogdom Luxemburg



JEAN-LOUP PIERRE
+33 6 34 78 95 11
jeanloupp@outils-polet.fr
Bretagne, Normandie,
Pays de la Loire



HANS-JÖRG REICHL
+49 171 7584652
Handelsagentur
hreichl@t-online.de
Duitsland - Zwitserland



ALEXANDRE MERCHEZ
+33 7 71 35 87 03
alexandrem@outils-polet.fr
Hauts-de-France, Champagne-Ardenne,
Lorraine



THIERRY VANWINKEL
+33 6 34 78 95 12
thierryv@outils-polet.fr
Île-de-France, Centre, Alsace,
Bourgogne, Franche-Comté,
Poitou-Charentes, Limousin,
Auvergne, Rhône-Alpes,
Aquitaine, Midi-Pyrénées,
Languedoc-Roussillon,
Provence-Alpes-Côte d'Azur

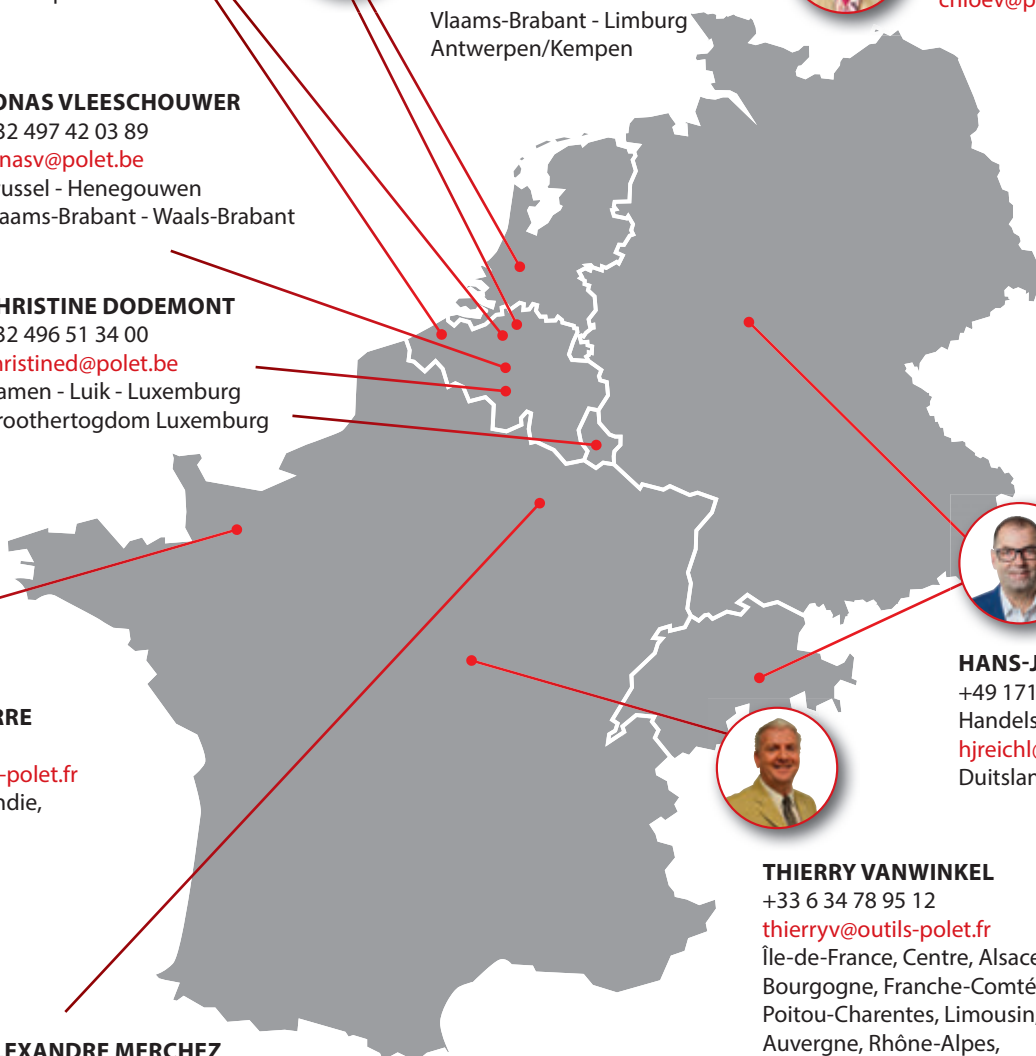

GARANTIE

Alle Polet gereedschappen zijn gewaarborgd tegen fabricagefouten, bij het normale gebruik waarvoor ze bestemd zijn. Niettegenstaande er nauwlettend toegezien wordt op de kwaliteit van de producten kan er zich uitzonderlijk toch een probleem stellen.

EEN PAAR VOORBEELDEN VAN GARANTIE:

- er breekt een stuk uit het stalen gedeelte van het gereedschap
- de veer van een spade scheurt af of de klinknagel komt los
- de steel breekt dwars over (sprok hout)
- loskomen van een gelijmde glasvezelsteel

WAT NIET ONDER GARANTIE VALT IS BIJVOORBEELD:

- gereedschap dat duidelijk reeds lang en intensief gebruikt is
- geplooid gereedschap
- voorhamers en kliefhamers waar de steel duidelijk sporen van mislaan vertoont
- duidelijk verkeerd gebruik van het gereedschap : een spade wordt niet als hefboom gebruikt, een geplooid spadesblad of een steel die in de lengterichting barst zijn daar duidelijk het bewijs van.

Voor de garantieregeling bestaan vastgelegde normen en omschrijvingen. U kunt ons hiervan een kopie vragen. Eventuele vervanging of creditering kan pas gebeuren nadat het defecte stuk aan ons terugbezorgd werd en door ons beoordeeld.

RETOURREGELING



Goederen die moeten teruggenomen worden om reden van garantie of fout bij bestelling en levering moeten vergezeld zijn van een retourbon. Sterk beschadigde retourgoederen kunnen slecht aan een gedeeltelijke waarde gecrediteerd worden. Contacteer steeds eerst uw vertegenwoordiger om de retourregeling te bespreken. Bent u een eindgebruiker dan raden we u aan om steeds eerst contact op te nemen met uw verkooppunt.

PRODUCTFICHE

Korte omschrijving met afmetingen van gereedschap en steel

Standaard aantal per verpakkingseenheid



Art. Nr.	Verpakking	Code steel
PT101384	5	PT131390H
 541068 884102		

AFKORTINGEN

2V	2 voetjes	PROF.	Professionele
4Z	4-zijdig	POL.	Gepolijst
B-ST	Bolsteel	RE.V	Voetje rechts
D-ST	D-steel	ST	Steel
FIB.	FIBER	T	Tand(en)
LI.V	Voetje links	T-ST	T-steel
M/ST	Met steel	ZH	Zwanehals

Barcode / EAN code

Icoontjes

De foto's zijn enkel indicatief en kunnen afwijken van het geleverde product. De producten zijn onderhevig aan wijzigingen.

ICONEN

GEBRUIK

-  Graven, planten en grondwerken
-  Ontwortelen van bomen, struiken en planten
-  Verwijderen van onkruid
-  Verwijderen en planten van aardappelen
-  Opruimen en verzamelen van (tuin)afval
-  Gazon
-  Bosbouwwerkzaamheden
-  Opruimen van de border
Snoeien van bloemen en takken
-  Biologisch alternatief
-  Plukken van fruit en vruchten
-  Stenige bodem
-  Bouw
-    Voederen en verwijderen van mest bij paarden, runderen en pluimvee
-  Hekwerk
-  Hooi, stro en graan
-  Aquality reeks
-  Scheppen van (hout)pellets

EIGENSCHAPPEN

-  Zachte handgreep
-  Met coating = sterke en soepele greep
-  Kan een aanzienlijk gewicht dragen
-  Sterk, robuust en duurzaam
-  Ergonomisch
-  Geschikt voor rechtshandigen
-  Geschikt voor linkshandigen
-  Super licht
-  Flexibele steel
-  Veer
-  Scherp geslepen
-  Zelfslijpend
-  Waterbestendig, neemt geen water op
Waterdicht of geschikt voor natte werkzaamheden
-  Vorst- en sneeuwbestendig
-  Geschikt voor alle seizoenen
-  Telescopische steel
-  Low vibe hamer reeks
-  Schop met rechte hoek
-  Spade met voetsteun
-  IJzerdikte spadeblad, uitgedrukt in millimeter
-  Diameter steel, uitgedrukt in millimeter met specificatie bolsteel, T-steel of D-steel
-  Hardheid van staal, uitgedrukt in Rockwellhardheid (HR) 50+ op de Hardness Rockwell C-schaal
-  Volle wielen = geen risico op lekke banden
-  Open / op slot
-  Anti-twist
-  Aquality, universeel compatibel met andere merken
-  Aquality, aqua stop
-  Aquality, max flow koppelingen

MATERIAAL



Aluminium
Licht en slijtvast



Lichte, holle polyamide steel versterkt met glasvezel
3x sterker dan houten steel



Steel met glasvezelkern omringd door PVC
5x sterker dan houten steel



Steel met volle glasvezelkern
10x sterker dan houten steel



Koolstofvezel steel



Koolstofstaal



Aluminium metaal



Vol metaal



Roestvrij staal



Inox



Polypropyleen
Vochtbestendig en flexibel



Acrylonitril-butadien-styreen
Vormvast en licht, maar hard en slagvast



Essenhouten steel



Polyamide



Koperen koppeling

GASBRANDERS



Gasbrander als alternatieve onkruidbestrijding



Tot 1750°C



Piezo ontsteking

INHOUD

POLET TRADITIONAL

SPADES 13

SCHOPPEN 18

ZANDSCHOPPEN 18

KABELSCHOPPEN 19

BETONSCHOPPEN 19

BATS 20

RIOOLSCHOPPEN 20

TUINGEREEDSCHAP 23

SCHOFFELS LIMBURG 23

HAKKEN RECHT 24

HAKKEN AFGEROND 27

HAKKEN TRAPEZIUM 29

STEEK- EN BEUGELHAKKEN 30

HAKKEN 30

HOUWEEL/LANDHAKKEN 31

CULTIVATORS 32

TUINKRAUWEL/HARKEN 34

GRASHARKEN 35

GRASKANTSTEKERS 36

HANDGEREEDSCHAPPEN 37

PLANTERS 44

HOUT- EN BOSGEREEDSCHAP 45

BOUW 48

GRONDBOREN 48

DALLENHAMERS 50

HEFBOMEN 50

ROOSTERHAAK 52

SNIJMES KABELISOLATIE 52

PLAKTRUWELEN 53

STRATENMAKERSHAMERS 53

STELLEN EN TOEBEHOREN 54

SPADES & SCHOPPEN

SPADES 58

PLANT- EN BOOMSPADES PROFESSIONAL 61

GRONDWERKSPADES PROFESSIONAL 63

GRONDWERKSPADES 64

TUINSPADES PROFESSIONAL 64

TUINSPADES 69

SPADES MET MASSIEVE ZWANENHALSDUL 71

SPADES MET OPEN DUL 72

ROESTVRIJSTALEN SPADES-RVS 75

SCHOPPEN & BATSEN 76

ZANDSCHOPPEN 77

KABELSCHOPPEN 81

DRENTSE BATSEN 82

BETONSCHOPPEN 90

ZWANEHALSSCHOPPEN 93

FRANKFURTERSCHOPPEN 95

BALASTSCHOPPEN 95

ALUMINIUM SCHOPPEN + SLIJTSTRIPPEN 96

SNEEUWSCHOPPEN + SNEEUWSCHUIVERS 103

STALSCHRAPERS 105

GARDENING

RIEKEN EN VORKEN 108

RIEKEN MET DUL 109

RIEKEN MET LIPDUL 111

RIEKEN MET VEERBUSSTEEL 112

SPITHAKEN-MESTHAKEN-CULTIVEERHAKEN 113

TUINKRAUWEL 114

HOOIVORKEN MET VEERBUSSTEEL 115

SPITVORKEN MET DUL 115

SPITVORKEN MET VEERBUSSTEEL 117

WOELVORKEN 118

COMPOST 120

LANDBOUWRIEKEN MET LIDPUL 121

STEENRIEKEN - PUINRIEKEN	122
STALVORKEN	122
HAKKEN EN SCHOFFELS	125
HAKKEN	125
HAKKEN MODEL NEDERLAND	129
SCHOFFELS	130
SCHOFFELS MODEL NEDERLAND	132
HOUWELEN-LANDHAKKEN	134
CULTIVATOREN	136
ALTERNATIEVE ONKRUIDBESTRIJDING	138
WEEDROLLER	139
WIELSCHOFFEL	140
U-SHOFFELHAK	145
VLEUGELSHOFFEL	146
GEKARTELD VOEGENMES	147
STRAATREINIGINGSMATERIAAL	147
ONKRUIDBRANDERS	150
GARDENING 4 KIDS	153
JUNIOR TOOLS	156
KINDERKRIWAGEN-BOLDERKAR	159
HANDGEREEDSCHAP	160
HANDGEREEDSCHAP MET MEDIUM STEEL	160
HANDGEREEDSCHAP	161
MEELSCHIPPEN	164
MULTISCHEP	164
HANDSCHOENEN	165
POLET KNIEKUSSEN	166
PLANTGEREEDSCHAP	166
HARKEN	168
BLADHARKEN	168
MULTIHARK	174
TUINHARKEN	174
LANDHARKEN	178
GAZONHARKEN-VERTICUTEERHARKEN	179
GAZONHARKEN-POLYAMIDE	181

HOOIRIJVEN-POLYAMIDE	182
GRASKANTSTEKERS	182
MAAIGEREEDSCHAP	183
SNOEIGEREEDSCHAPPEN	185
GRAS- EN BUXUSSCHAREN	186
SNOEISCHAREN	186
FRUITSCHAREN	189
HEGGESCHAREN	189
TAKKENSCHAREN	190
SNOEIZAGEN	191
BEUGELZAGEN	192
TUIN- EN HOBBYMESSEN	193
ACCESSOIRES	193
HOUT- EN BOSGEREEDSCHAP	194
FORESTRY TOOLS	195
HANDBIJLTJES	196
BIJLEN	197
KLIEFHAMERS	197
WIGGEN	198
KAPMESSEN	199
ZAAGBOKKEN	201
PALENBOREN	202
SPIRAALBOREN	202
SCHROEFBOREN	203
DUBBELE SCHELPSPADE	203
TUINHAMERS-SLEGGEN	203
PALENDAMMERS	204
POLET BAGS	205
TUBTRUGS	206
FLEXIBLE	206
RECYCLED	210
EMMERS	210
MANDEN	211
KUIPEN	212

CONSTRUCTION

METSERS- EN STUKADOORSGEREEDSCHAP 214

TUBTRUG GORILLA.....	214
GORILLA BUCKETS.....	215
METSERSKUIPEN.....	215
TRUWELEN.....	216
VOEGERS.....	217
PLAKTRUWELEN.....	218
WATERPASSERS.....	219
KLEMHAKEN.....	220
METSERSPRIEM.....	221
GRIFFEN.....	221
BITUMENSTEKERS.....	222

NIVELEERGEREEDSCHAP ALU..... 224

NIVELEERSCHUIVERS BETON EN BITUMEN.....	224
BETONVERDELERS MET VERSTELBARE HULS.....	224
STELLEN VOOR NIVELEERGEREEDSCHAP.....	225
ALUMINIUM VLOERWISSERS INDUSTRIEEL.....	225

ASFALTHARKEN..... 226

BESTRATINGSGEREEDSCHAP..... 228

GRONDDAMMERS.....	228
DALLENHAMERS.....	228
BESTRATINGSHAMERS-KASSEIHAMERS.....	228
DRAAGTANGEN.....	229
GESMEEDWALSTE PIKHOUWELEN.....	229

BEITELS..... 230

PUNTBEITELS.....	230
PLATTE BEITELS.....	231
CAROSSERIEBEITEL.....	232
VOEGBEITELS.....	232
BEITELDISPLAY.....	232
HANDBESCHERMING VOOR BEITELS.....	232

HEFBOMEN EN STOOTIJZERS..... 233

HEFBOOM-STOOTIJZER FIBER 9001.....	233
HEFBOOM MET VOET.....	233

HEFBOOM MET BOL EN PUNT.....	233
HEFBOOM MET BOL EN BEITEL.....	234
KASSEIHEFBOOM/STRAATMAKERSHEFBOOM..	234
HEFBOOM MET KUNSTSTOF SLAGDOP 50MM..	235

KOEVOETEN..... 235

ZESKANT.....	235
OVAAL.....	236
VLAK.....	237
ALU.....	237

HAMERS..... 238

HAMERS MET LOW VIBE STEEL.....	238
KLAUWHAMERS.....	239
BANKHAMERS-DIN 1041.....	240
VOORHAMERS-DIN 6475 EN 1042.....	241
MOKERS-DIN 6475.....	244
NUPLA SOFTFACE HAMERS.....	245
DOPPEN OP KAART.....	246

CLEANING

BEZEMS EN VEGERS..... 248

HANDBORSTELS.....	248
ZAALBEZEMS.....	251
STRAAT- EN TERRASBEZEMS.....	253

GORILLA BROOMS..... 263

GRIJPTANGEN EN DRAAGRING..... 264

VLOERWISSERS..... 267

STELLEN EN TOEBEHOREN

SPADESTELLEN..... 271

POLET TRADITIONAL.....	271
FIBER 3001 STELEN.....	272
T-STEEL.....	273
T-STEEL GEBOGEN.....	275
D-STEEL.....	275
BOLSTEEL.....	276

SCHOPSTELLEN..... 277

POLET TRADITIONAL.....	277
------------------------	-----

FIBER 3001 STELEN.....	277
SCHOPSTELLEN GEBOGEN / ES-BEUK.....	277
SCHOPSTELLEN RECHT / ES-BEUK.....	278

BATSSTELLEN 278

FIBER 3001 STELEN.....	278
BATSSTELLEN HOUT.....	279

TELESCOPISCHE STEEL..... 280

RIEK- EN VORKSTELLEN..... 280

RIEKSTELLEN MET VEERBUS.....	280
VORKSTELLEN.....	281
RIEKSTELLEN MET D-GREEP.....	282

RIJF- EN HARKSTELLEN..... 282

SCHOFFELSTELLEN MET HILT..... 284

BORSTEL- EN BEZEMSTELLEN..... 285

LANDHAK- EN TUINHAKSTELLEN..... 285

GARDENING 4 KIDS STELEN..... 286

BIJLSTELLEN..... 287

HAMERSTELLEN..... 288

KLIEF-EN VOORHAMERSTELLEN.....	288
POLET TRADITIONAL KASSEIHAMERSTEEL.....	289
HANDHAMERSTELLEN ES.....	289

DALHAMERBLOKKEN..... 291

TUINHAMERSTELLEN..... 291

PIKHOUWHEELSTELLEN..... 292

STELLEN ALU BETON SCHUIVERS..... 293

KLEINE STELEN..... 293

TRUWHEELHECHTEN.....	293
VIJLHECHTEN.....	293

TOEBEHOREN..... 294

SPIEËN VOOR INSTELLEN.....	294
TOEBEHOREN VOOR SPADES.....	295

KUNSTSTOFHANDGREPEN.....	295
--------------------------	-----

ALL-FIX.....	296
--------------	-----

AQUALITY

SLANGENHASPELS..... 298

PROFESSIONELE SLANGENHASPELS.....	298
SLANGENHASPELS.....	300
VERVANGSTUKKEN EN ACCESSOIRES.....	301

TUINSLANGEN..... 302

GOOD AQUALITY.....	302
BUILDING EXPERT AQUALITY.....	303
PRO AQUALITY.....	303
SLANGENGELEIDER.....	304

SPROEIMATERIAAL..... 304

KLAUWKOPPELINGEN EN ONDERDELEN.....	304
BRASS KOPPELINGEN EN ONDERDELEN.....	308
MAX FLOW.....	310
KRAANSTUKKEN-KOPPELINGEN.....	312
PISTOLEN EN SPROEILANSEN.....	318
SPROEIERS.....	319

DRUKSPROEIERS..... 321

GIETERS EN EMMERS

GEGALVANISEERD..... 324

0,45 MM.....	324
0,70 MM.....	325



FORGED FOR LIFE

De gereedschappen uit de reeks "Polet Traditional" worden nog steeds op ambachtelijke wijze vervaardigd, met extra aandacht voor de keuze van de staalsoort, smeden en harden van het staal.

Het resultaat zijn gereedschappen van topkwaliteit, waaraan zowel de professional als de fervente tuinliefhebber jarenlang plezier beleeft.





De hele reeks tuingereedschappen van **Polet Traditional** wordt gemaakt van hoogwaardig staal. Elk gereedschap wordt uitgesmeed en gehard in eigen productie volgens vakmanschap met Belgische know-how. Voor ze in de winkel belanden wordt het gereedschap individueel geslepen zodat er steeds een uitermate scherpe snede aan de tuingereedschappen is.



TAILORMADE

De productie van de Polet Traditional reeks gebeurt op een andere manier dan bij een massaproductie het geval is. Elk stuk gereedschap is handgesmeed waardoor geen enkele schop of hak identiek is. Behalve de authenticiteit en de optimale kwaliteit kunnen klanten daardoor in principe ook gepersonaliseerde gereedschappen aanvragen. Zo kunnen bijvoorbeeld een extra scherpe rand of een afwijkende vorm in overleg met de firma bekomen worden.

TAILORMADE: GEREEDSCHAP OP MAAT



STEEL

- ergonomisch: door de lange steel met hilt blijft de rug recht.



STEEL

- hickory hout (soort notelaar) is bijzonder sterk en veerkrachtig
- geschikt voor het zwaardere werk

Door het ambachtelijke procédé van het smeden zijn de spades geschikt voor de zwaarste taken, zoals kabelwerken tot het verplanten van bomen en struiken.

BLAD







- hoogwaardig gesmeed koolstofstaal
- extra gehard
- slijtvast & duurzaam
- goed scherp & zelfslijpend door het geleidelijk dunner wordend blad



SPADES







TRADITIONAL SPADE 285/180 T-ST 95CM



Art. Nr.	Verpakking	Code steel
PT102007	5	PT131295H
 5 410685 869628		    







TRADITIONAL HOVENIERSPADE 285/140 T-ST 95CM



Art. Nr.	Verpakking	Code steel
PT101284	1	PT131295H
 5 410685 874165		    







TRADITIONAL HOVENIERSSPADE 285/180 D-ST ES 90CM



Art. Nr.	Verpakking	Code steel
PT102288	1	PT132390
 5 410685 875025		    







TRADITIONAL GROENTESPADE 310/170 T-ST ES 95CM



Art. Nr.	Verpakking	Code steel
PT101317	1	PT131395
 5 410685 871249		    







TRADITIONAL HOFSPADE 330/160 T-ST 95CM



Art. Nr.	Verpakking	Code steel
PT101336	1	PT131295H
 5 410685 871256		    

TRADITIONAL HOFSPADE 330/160 D-ST ES 90CM



Art. Nr.	Verpakking	Code steel
PT102336	1	PT132390
 5 410685 876336		    

TRADITIONAL ZWARE HOFSPADE 330/160 T-ST 90CM



Art. Nr.	Verpakking	Code steel
PT101336Z	1	PT137390H

TRADITIONAL GRONDWERK SPADE 380/130 T-ST 85CM



Art. Nr.	Verpakking	Code steel
PT101383	1	PT131385H

TRADITIONAL GRONDWERK SPADE 420/130 T-ST 78CM



Art. Nr.	Verpakking	Code steel
PT101423	1	PT131378H

TRADITIONAL SPADE SENLIS 280/180/2,5 2V B-ST ES 110CM



Art. Nr.	Verpakking	Code steel
PT103288	5	PT133305

TRADITIONAL SPADE SENLIS 280/180/2,5 2V T-ST 95CM



Art. Nr.	Verpakking	Code steel
PT101288	5	PT131295H







TRADITIONAL GRONDWERK SPADE 360/140 T-ST 90CM



Art. Nr.	Verpakking	Code steel
PT101384	5	PT131390H







TRADITIONAL GRONDWERK SPADE 360/140 D-ST ES 90CM



Art. Nr.	Verpakking	Code steel
PT102384	1	PT132390
 5 410685 877609		    







TRADITIONAL GRONDWERK SPADE 470/130 2V T-ST 70CM



Art. Nr.	Verpakking	Code steel
PT101473	1	PT131370H
 5 410685 870389		    







TRADITIONAL GRONDWERK SPADE 470/130 2V T-ST 95CM



Art. Nr.	Verpakking	Code steel
PT101474	1	PT131295H
 5 410685 875278		    







TRADITIONAL GRONDWERK SPADE STAAL 380/140 2V T-ST 122CM



Art. Nr.	Verpakking	Code steel
PT101384ST	1	-
 5 410685 879405		    







TRADITIONAL GRONDWERK SPADE STAAL 380/140 2V B-ST 125CM



Art. Nr.	Verpakking	Code steel
PT103384ST	1	-
 5 410685 885178		    

TRADITIONAL BOOMSPADE 380/125 T-ST 85CM



Art. Nr.	Verpakking	Code steel
PT101005	1	PT137385H
 5 410685 869604		    

TRADITIONAL BOOMSPADE 380/125 2V FIBER 9001 85CM



Art. Nr.	Verpakking	Code steel
PT101005F	5	SHT32

TRADITIONAL LANGE BOOMSPADE 420/125 T-ST 85CM



Art. Nr.	Verpakking	Code steel
PT101422	1	PT137385H

TRADITIONAL LANGE BOOMSPADE 460/125 T-ST 85CM



Art. Nr.	Verpakking	Code steel
PT101462	1	PT137385H

TRADITIONAL DAMESSPADE 230/120 T-ST ES 95CM



Art. Nr.	Verpakking	Code steel
PT101232	1	PT131295

TRADITIONAL DAMESSPADE 270/135 B-ST ES 110CM



Art. Nr.	Verpakking	Code steel
PT103001	1	PT133305



TRADITIONAL DAMESSPADE 270/135 T-ST ES 95CM



Art. Nr.	Verpakking	Code steel
PT101001	5	PT131295



TRADITIONAL DAMESSPADE 285/155/2,5 2V T-ST ES 95CM



Art. Nr.	Verpakking	Code steel
PT101002	1	PT131295
 5 410685 883099		



TRADITIONAL SPADE ZWANEHALS 280/150/165 T-ST ES 75CM



Art. Nr.	Verpakking	Code steel
PT101028	1	PT131301
 5 410685 876473		



TRADITIONAL PIJPSPADE 420/100/3 D/ST 150CM



Art. Nr.	Verpakking	Code steel
PT101421	1	PT132150
 5 410685 873779		

TRADITIONAL PIJPSPADE 420/100/3 D-ST 250CM



Art. Nr.	Verpakking	Code steel
PT102421	1	PT132250
 5 410685 876282		





SCHOPPEN

ZANDSCHOPPEN



TRADITIONAL ZANDSCHOP NR1-290X230MM



Art. Nr.	Verpakking	Code steel
PT110201	10	-
		



TRADITIONAL ZANDSCHOP NR1 M/ST 1,3M



Art. Nr.	Verpakking	Code steel
PT110211S	5	PT141213A
		



TRADITIONAL ZANDSCHOP NR2-290X240MM



Art. Nr.	Verpakking	Code steel
PT110202	10	-
		



TRADITIONAL ZANDSCHOP NR2 M/ST 1,3M



Art. Nr.	Verpakking	Code steel
PT110212S	5	PT141213A
		



TRADITIONAL ZANDSCHOP NR00-265X220MM



Art. Nr.	Verpakking	Code steel
PT110206	1	-
		

TRADITIONAL ZANDSCHOP NR00 M/ST 1,3M



Art. Nr.	Verpakking	Code steel
PT110216S	1	PT141213A
		

KABELSCHOPPEN

TRADITIONAL KABELSCHOP



Afmeting	Art. Nr.	Verpakking	Code steel	
120MM-2MM	PT110312	1	-	 5410685870174
140MM-2MM	PT110314	1	-	 5410685870457
160MM-2MM	PT110316	1	-	 5410685870464
180MM-2MM	PT110318	1	-	 5410685873175

TRADITIONAL KABELSCHOP M/ST 1,3M



Afmeting	Art. Nr.	Verpakking	Code steel	
120MM-2MM	PT1103121	1	PT141213A	 5410685870624
140MM-2MM	PT1103141	1	PT141213A	 5410685870631
160MM-2MM	PT1103161	1	PT141213A	 5410685870372
180MM-2MM	PT1103181	1	PT141213A	 5410685873182

BETONSCHOPPEN

TRADITIONAL BETONSCHOP NR1-290X230MM



Art. Nr.	Verpakking	Code steel
PT110601	1	-
 5 410685 870907		





TRADITIONAL BETONSCHOP NR1 M/ST 1,3M



Art. Nr.	Verpakking	Code steel
PT110611S	1	PT141213A
 5 410685 870921		





TRADITIONAL BETONSCHOP NR1 2MM DIK-290X230MM



Art. Nr.	Verpakking	Code steel
PT110601Z	1	-
 5 410685 873861		   





TRADITIONAL BETONSCHOP NR2-290X240MM



Art. Nr.	Verpakking	Code steel
PT114602	1	-
 5 410685 875421		   

TRADITIONAL BETONSCHOP NR2 M/ST 1,3M







Art. Nr.	Verpakking	Code steel
PT110612S	1	PT141213A
 5 410685 870938		   

BATS

TRADITIONAL BATS 000/35 T-ST 1,1M







Art. Nr.	Verpakking	Code steel
PT112342	1	PT1911022
 5 410685 876480		   

RIOOLSCHOPPEN





TRADITIONAL RIOOLSCHOP B100XL285XH90



Art. Nr.	Verpakking	Code steel
PT113280	1	-
 5 410685 883235		   



TRADITIONAL RIOOLSCHOP B100XL285XH90 M/ST 1,3M



Art. Nr.	Verpakking	Code steel
PT113281	5	PT141213A
 5 410685 879023		   



TRADITIONAL RIOOLSCHOP B100XL285XH90 FIBER 1,3M



Art. Nr.	Verpakking	Code steel
PT113281F	1	FH141223
 5 410685 883242		

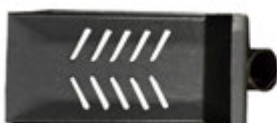

TRADITIONAL RIOOLSCHOP B115XL200XH70



Art. Nr.	Verpakking	Code steel
PT113110	1	-
 5 410685 883211		



TRADITIONAL RIOOLSCHOP B115XL200XH70 M/ST 1,3M



Art. Nr.	Verpakking	Code steel
PT113111	5	PT141213A
 5 410685 880067		

TRADITIONAL RIOOLSCHOP B115XL200XH70 FIBER 1,3M



Art. Nr.	Verpakking	Code steel
PT113111F	1	FH141223
 5 410685 883327		



SCHOFFEL MET HILTSTEEL

Terwijl de Belgen nog steeds graag aan de slag gaan met een hak om onkruid weg te kappen, zijn de Nederlanders fan van de schoffel. Met een schoffel maak je eerder een duwende beweging en dat heeft veel voordelen. Enkele biolandbouwers, zowel mannen als vrouwen, hebben de schoffel uitvoerig getest. Ze hebben er onkruid mee verwijderd, ondergrond gewied, grond voorbereid en geschoffeld tussen kruiden. Dit zijn hun reacties:



KAREL

Het was even wennen, maar na een tijdje word je het gebruik helemaal gewoon. De schoffel ligt heel goed in de hand en ik heb het gevoel dat het onkruid gemakkelijker wordt verwijderd. Ik moet ook minder hard duwen, zelfs op stenige of hardere ondergrond. Ik zou mijn schoffel nooit meer inwisselen voor een hak.

TANJA

In tegenstelling tot wanneer ik een hak gebruik, heb ik bij de schoffel geen last van mijn armen en rug. Door de langere steel is de werklust immers veel kleiner. Je kan zelfs met één hand werken! Heel gebruiksvriendelijk en ergonomisch.



WILLEM

Wat ik vooral goed vind aan de schoffel, is dat de grond niet te veel wordt verstoord. Je kunt er bovendien heel gemakkelijk overtollig gras en onkruid mee verwijderen. Ook voor kolen en andere grovere teelten is de schoffel zeer handig. Waar je met een hak kapt en trekt, kan je met een schoffel immers dúwen en trekken! Ik ben ook fan van het handvat en de langere steel.



TUINGEREEDSCHAP

SCHOFFELS LIMBURG

TRADITIONAL SCHOFFEL LIMBURG



Afmeting	Art. Nr.	Verpakking	Code steel	
8x5CM	PT039008	1	-	 5410685874073
10x5CM	PT039010	1	-	 5410685874080
12x5CM	PT039012	1	-	 5410685874325
14x5CM	PT039014	1	-	 5410685874097
16x5CM	PT039016	1	-	 5410685874257
18x5CM	PT039018	1	-	 5410685874103
20x5CM	PT039020	1	-	 5410685874332
22x5CM	PT039022	1	-	 5410685875186
24x5CM	PT039024	1	-	 5410685875193
26x5CM	PT039026	1	-	 5410685875209

TRADITIONAL SCHOFFEL LIMBURG HILTST 1,5M



Afmeting	Art. Nr.	Verpakking	Code steel	
8x5CM	PT0390081H	1	PT1925016	 5410685874349
10x5CM	PT0390101H	1	PT1925016	 5410685870969
12x5CM	PT0390121H	1	PT1925016	 5410685874226
14x5CM	PT0390141H	1	PT1925016	 5410685869857
16x5CM	PT0390161H	1	PT1925016	 5410685871713
18x5CM	PT0390181H	1	PT1925016	 5410685873236
20x5CM	PT0390201H	1	PT1925016	 5410685874356

TRADITIONAL SCHOFFEL LIMBURG M/ST 1,5M



Afmeting	Art. Nr.	Verpakking	Code steel	
8x5CM	PT0390081	1	PT143650	 5410685871201
10x5CM	PT0390101	1	PT143650	 5410685874295
12x5CM	PT0390121	1	PT143650	 5410685873908
14x5CM	PT0390141	1	PT143650	 5410685869529
16x5CM	PT0390161	1	PT143650	 5410685873816
18x5CM	PT0390181	1	PT143650	 5410685874301
20x5CM	PT0390201	1	PT143650	 5410685874318

HAKKEN RECHT

TRADITIONAL HAK RECHT LAAG



Afmeting	Art. Nr.	Verpakking	Code steel	
6x4,5CM	PT037306	1	-	 5410685875575
8x4,5CM	PT037308	1	-	 5410685875582
10x5CM	PT037310	1	-	 5410685875599
12x5,5CM	PT037312	1	-	 5410685875605
14x5,5CM	PT037314	1	-	 5410685874707
16x5,5CM	PT037316	1	-	 5410685875407
18x6CM	PT037318	1	-	 5410685874714
20x6CM	PT037320	1	-	 5410685874721
22x6CM	PT037322	1	-	 5410685874738
24x6CM	PT037324	1	-	 5410685874745

TRADITIONAL HAK RECHT LAAG M/ST 1,5M



Afmeting	Art. Nr.	Verpakking	Code steel	
6x4,5CM	PT0373061	1	PT143650	 5410685875612
8x4,5CM	PT0373081	1	PT143650	 5410685871683
10x5CM	PT0373101	1	PT143650	 5410685871690
12x5,5CM	PT0373121	1	PT143650	 5410685871867
14x5,5CM	PT0373141	1	PT143650	 5410685869512
16x5,5CM	PT0373161	1	PT143650	 5410685871850
18x6CM	PT0373181	1	PT143650	 5410685871706
20x6CM	PT0373201	1	PT143650	 5410685875629
22x6CM	PT0373221	1	PT143650	 5410685875636
24x6CM	PT0373241	1	PT143650	 5410685875643



TRADITIONAL HAK RECHT HOOG



Afmeting	Art. Nr.	Verpakking	Code steel	
6x5,5CM	PT037406	1	-	 5410685874288
8x6CM	PT037408	1	-	 5410685874127
10x6CM	PT037410	1	-	 5410685874134
12x6,5CM	PT037412	1	-	 5410685874141
14x7CM	PT037414	1	-	 5410685875650
16x8CM	PT037416	1	-	 5410685875667
18x8,5CM	PT037418	1	-	 5410685875674
20x9,5CM	PT037420	1	-	 5410685875681
22x9,5CM	PT037422	1	-	 5410685875698
24x9,5CM	PT037424	1	-	 5410685875704



TRADITIONAL HAK RECHT HOOG M/ST 1,5M



Afmeting	Art. Nr.	Verpakking	Code steel	
6x5,5CM	PT0374061	1	PT143650	 5410685871669
8x6CM	PT0374081	1	PT143650	 5410685873106
10x6CM	PT0374101	1	PT143650	 5410685873090
12x6,5CM	PT0374121	1	PT143650	 5410685873113
14x7CM	PT0374141	1	PT143650	 5410685873120
16x8CM	PT0374161	1	PT143650	 5410685871003
18x8,5CM	PT0374181	1	PT143650	 5410685872819
20x9,5CM	PT0374201	1	PT143650	 5410685872826
22x9,5CM	PT0374221	1	PT143650	 5410685875711
24x9,5CM	PT0374241	1	PT143650	 5410685875728

HAKKEN AFGEROND

TRADITIONAL HAK AFGEROND LAAG



Afmeting	Art. Nr.	Verpakking	Code steel	
8x4,5CM	PT037108	1	PT143650	 5410685873274
10x5CM	PT037110	1	PT143650	 5410685873281
12x5,5CM	PT037112	1	PT143650	 5410685875087
14x5,5CM	PT037114	1	PT143650	 5410685875094
16x5,5CM	PT037116	1	PT143650	 5410685876091

TRADITIONAL HAK AFGEROND LAAG M/ST 1,5M



Afmeting	Art. Nr.	Verpakking	Code steel	
8x4,5CM	PT0371081	1	PT143650	 5410685876138
10x5CM	PT0371101	1	PT143650	 5410685876145
12x5,5CM	PT0371121	1	PT143650	 5410685875377
14x5,5CM	PT0371141	1	PT143650	 5410685876152
16x5,5CM	PT0371161	1	PT143650	 5410685876169

TRADITIONAL HAK AFGEROND HOOG



Afmeting	Art. Nr.	Verpakking	Code steel	
8x6CM	PT037208	1	-	 5410685874752
10x6CM	PT037210	1	-	 5410685874769
12x6,5CM	PT037212	1	-	 5410685874776
14x7CM	PT037214	1	-	 5410685873663
16x8CM	PT037216	1	-	 5410685873656
18x8,5CM	PT037218	1	-	 5410685873649
20x9,5CM	PT037220	1	-	 5410685874783
22x9,5CM	PT037222	1	-	 5410685874790
24x9,5CM	PT037224	1	-	 5410685874806

TRADITIONAL HAK AFGEROND HOOG M/ST 1,5M



Afmeting	Art. Nr.	Verpakking	Code steel	
8x6CM	PT0372081	1	PT143650	 5410685876015
10x6CM	PT0372101	1	PT143650	 5410685876022
12x6,5CM	PT0372121	1	PT143650	 5410685876039
14x7CM	PT0372141	1	PT143650	 5410685876046
16x8CM	PT0372161	1	PT143650	 5410685876053
18x8,5CM	PT0372181	1	PT143650	 5410685871744
20x9,5CM	PT0372201	1	PT143650	 5410685876060
22x9,5CM	PT0372221	1	PT143650	 5410685876077
24x9,5CM	PT0372241	1	PT143650	 5410685876084

HAKKEN TRAPEZIUM

TRADITIONAL HAK TRAPEZIUM MET PUNT 14CM



Art. Nr.	Verpakking	Code steel
PT037314TR	1	-
 5 410685 885208		

TRADITIONAL HAK TRAPEZIUM MET PUNT 14CM M/ST 1,5M



Art. Nr.	Verpakking	Code steel
PT0373141TR	1	PT143650
 5 410685 885574		

STEEL-EN BEUGELHAKKEN

TRADITIONAL STEEK- EN BEUGELHAK



Afmeting	Art. Nr.	Verpakking	Code steel	
12x4,5CM	PT031012	1	-	 5410685876237
14x4,5CM	PT031014	1	-	 5410685876244
16x4,5CM	PT031016	1	-	 5410685876251
18x4,5CM	PT031018	1	-	 5410685876268

TRADITIONAL STEEK- EN BEUGELHAK HILTST 1,5M



Afmeting	Art. Nr.	Verpakking	Code steel	
12x4,5CM	PT0310121	1	PT1925016	 5410685873137
14x4,5CM	PT0310141	1	PT1925016	 5410685873670
16x4,5CM	PT0310161	1	PT1925016	 5410685875964
18x4,5CM	PT0310181	1	PT1925016	 5410685876206

HAKKEN

TRADITIONAL HAK CHAMPAGNE 15X16CM



Art. Nr.	Verpakking	Code steel
PT036036	1	-
 5 410685 885796		



TRADITIONAL HAK CHAMPAGNE 15X16CM M/ST 1,1M



Art. Nr.	Verpakking	Code steel
PT0360361	1	PT142545
 5 410685 889930		



TRADITIONAL HAK 190MM



Art. Nr.	Verpakking	Code steel
PT036030	1	142542
 5 410685 880937		



TRADITIONAL HAK 180MM 3T



Art. Nr.	Verpakking	Code steel
PT036033	1	142542
 5 410685 880944		



TRADITIONAL HAK 220MM 4T



Art. Nr.	Verpakking	Code steel
PT036034	1	142542
 5 410685 880951		

TRADITIONAL HAK 285MM 5T





Art. Nr.	Verpakking	Code steel
PT036035	1	142542
 5 410685 880968		

HOUWHEEL/LANDHAKKEN



TRADITIONAL HOUWHEEL CHAMPAGNE 80X230MM



Art. Nr.	Verpakking	Code steel
PT026002	1	-
 5 410685 885802		



TRADITIONAL HOUWHEEL/LANDHAK KLEIN 150X210MM



Art. Nr.	Verpakking	Code steel
PT045000	3	-
 5 410685 869536		



TRADITIONAL HOUWEEL KLEIN 150X210MM M/ST 1,5M



Art. Nr.	Verpakking	Code steel
PT0450001	3	PT142540
		



TRADITIONAL HOUWEEL/LANDHAK GROOT 180X210MM



Art. Nr.	Verpakking	Code steel
PT0450004	1	-
		



TRADITIONAL HOUWEEL GROOT 180X210MM M/ST 1,5M



Art. Nr.	Verpakking	Code steel
PT0450041	1	PT142540
		



TRADITIONAL HOUWEEL 140X210X5MM ZWAAR



Art. Nr.	Verpakking	Code steel
PT0450008	1	-
		

TRADITIONAL HOUWEEL 160X210X5MM ZWAAR





Art. Nr.	Verpakking	Code steel
PT0450009	1	-
		

CULTIVATORS



TRADITIONAL CULTIVATOR 1T VAST



Art. Nr.	Verpakking	Code steel
PT034021	1	-
		



TRADITIONAL CULTIVATOR 1T VAST M/ST 1,5M



Art. Nr.	Verpakking	Code steel
PT0340211	1	PT143650
 5 410685 874363		



TRADITIONAL CULTIVATOR 3T VAST KLEIN



Art. Nr.	Verpakking	Code steel
PT034123	1	-
 5 410685 874189		



TRADITIONAL CULTIVATOR 3T VAST KLEIN M/ST 1,5M



Art. Nr.	Verpakking	Code steel
PT0341231	1	PT143650
 5 410685 871881		



TRADITIONAL CULTIVATOR 3T VAST GROOT



Art. Nr.	Verpakking	Code steel
PT034023	1	-
 5 410685 874196		



TRADITIONAL CULTIVATOR 3T VAST M/ST 1,5M



Art. Nr.	Verpakking	Code steel
PT0340231	1	PT143650
 5 410685 869864		



TRADITIONAL CULTIVATOR 5T VAST



Art. Nr.	Verpakking	Code steel
PT034025	1	-
 5 410685 874202		

TRADITIONAL CULTIVATOR 5T VAST M/ST 1,5M





Art. Nr.	Verpakking	Code steel
PT0340251	1	PT143650
		 

TUINKRAUWEL/HARKEN



TRADITIONAL TUINKRAUWEL



Art. Nr.	Verpakking	Code steel
PT035030	1	-
		 



TRADITIONAL TUINKRAUWEL M/ST 1,5M



Art. Nr.	Verpakking	Code steel
PT0350301	1	PT143650
		 



TRADITIONAL TUINHARK 12T



Art. Nr.	Verpakking	Code steel
PT030212	1	-
		 



TRADITIONAL TUINHARK 12T M/ST 1,5M



Art. Nr.	Verpakking	Code steel
PT0302121	1	PT143650
		 



TRADITIONAL TUINHARK 14T



Art. Nr.	Verpakking	Code steel
PT030214	1	-
		 



TRADITIONAL TUINHARK 14T M/ST 1,5M



Art. Nr.	Verpakking	Code steel
PT0302141	1	PT143650
 5 410685 871737		



TRADITIONAL TUINHARK 16T



Art. Nr.	Verpakking	Code steel
PT030216	1	-
 5 410685 874974		

TRADITIONAL TUINHARK 16T M/ST 1,5M





Art. Nr.	Verpakking	Code steel
PT0302161	1	PT143650
 5 410685 874974		

GRASHARKEN



TRADITIONAL GRASHARK 10T



Art. Nr.	Verpakking	Code steel
PT070701	1	-
 5 410685 874882		



TRADITIONAL GRASHARK 10T M/ST 1,5M



Art. Nr.	Verpakking	Code steel
PT0707011	1	PT143650
 5 410685 873687		

TRADITIONAL GRASHARK 10T RECHTSHANDIG M/ST 1,5M



Art. Nr.	Verpakking	Code steel
PT0707011R	1	PT143650
 5 410685 871317		

GRASKANTSTEKERS

TRADITIONAL GRASKANTSTEKER 20CM ROND T-ST 95CM



Art. Nr.	Verpakking	Code steel
PT045003	1	PT138282

TRADITIONAL GRASKANTSTEKER 25CM ROND T-ST 95CM



Art. Nr.	Verpakking	Code steel
PT045001	5	PT138282

TRADITIONAL GRASKANTSTEKER RECHTE SNEDE T-ST 95CM



Art. Nr.	Verpakking	Code steel
PT045002	1	PT138282

TRADITIONAL SCHIETSCHOP RECHTSHANDIG



Art. Nr.	Verpakking	Code steel
PT045005	1	-

TRADITIONAL SCHIETSCHOP RECHTSHANDIG T-ST ES 95CM



Art. Nr.	Verpakking	Code steel
PT0450051	1	PT138282



TRADITIONAL SCHIETSCHOP LINKSHANDIG



Art. Nr.	Verpakking	Code steel
PT045006	1	-

TRADITIONAL SCHIETSCHOP LINKSHANDIG T-ST ES 95CM





Art. Nr.	Verpakking	Code steel
PT0450061	1	PT138282
 5 410685 879177		

HANDGEREEDSCHAPPEN



TRADITIONAL HANDSPADE RECHT M/ST 45CM



Art. Nr.	Verpakking	Code steel
PT070300	1	PT131345
 5 410685 869918		



TRADITIONAL HANDSPADE ROND M/ST 45CM



Art. Nr.	Verpakking	Code steel
PT070301	1	PT131345
 5 410685 873694		



TRADITIONAL VERPLANTSCHOPJE GEHARD



Art. Nr.	Verpakking	Code steel
PT030000	1	PT151321
 5 410685 869499		



TRADITIONAL VERPLANTSCHOPJE LANG HANDVAT



Art. Nr.	Verpakking	Code steel
PT030000L	1	PT151323
 5 410685 877944		

TRADITIONAL VERPLANTSCHOPJE SMAL GEHARD



Art. Nr.	Verpakking	Code steel
PT030001	1	PT151321
 5 410685 871751		

TRADITIONAL VERPLANTSCHOPJE RECHT GEHARD



Art. Nr.	Verpakking	Code steel
PT030002	1	PT151321

TRADITIONAL GROENTEHAKJE RECHT 8CM



Art. Nr.	Verpakking	Code steel
PT0330080	1	PT151321

TRADITIONAL GROENTEHAKJE RECHT 8CM LANG HANDVAT



Art. Nr.	Verpakking	Code steel
PT0330101	5	PT151323

TRADITIONAL GROENTEHAKJE RECHT 10CM



Art. Nr.	Verpakking	Code steel
PT0330100	1	PT151321

TRADITIONAL GROENTEHAKJE 10CM LANG HANDVAT



Art. Nr.	Verpakking	Code steel
PT0330102	1	PT151323



TRADITIONAL GROENTEHAKJE RECHT 12CM



Art. Nr.	Verpakking	Code steel
PT0330120	1	PT151321



TRADITIONAL GROENTEHAKJE 12CM LANG HANDVAT



Art. Nr.	Verpakking	Code steel
PT0330121	1	PT151323
 5 410685 878538		



TRADITIONAL PUNTHANDHAK 5X10CM



Art. Nr.	Verpakking	Code steel
PT0332011	1	PT151321
 5 410685 878002		



TRADITIONAL PUNTHANDHAK 5X10CM LANG HANDVAT



Art. Nr.	Verpakking	Code steel
PT0332010	1	PT151323
 5 410685 871768		



TRADITIONAL SCHREPEL LINKS 12X4CM



Art. Nr.	Verpakking	Code steel
PT0333012	1	PT151321
 5 410685 871812		



TRADITIONAL SCHREPEL RECHTS 12X4CM



Art. Nr.	Verpakking	Code steel
PT0333112	1	PT151321
 5 410685 871775		

TRADITIONAL SCHREPEL RECHTS 12X4CM LANG HANDVAT



Art. Nr.	Verpakking	Code steel
PT0333212	1	PT151323
 5 410685 879313		

TRADITIONAL SCHREPEL 12CM RECHTSHANDIG LANG HANDVAT



Art. Nr.	Verpakking	Code steel
PT1211012	1	PT151323

TRADITIONAL WIEDIJZER LINKSHANDIG LANG HANDVAT



Art. Nr.	Verpakking	Code steel
PT0336021	1	PT151323

TRADITIONAL WIEDIJZER RECHTSHANDIG LANG HANDVAT



Art. Nr.	Verpakking	Code steel
PT0336011	1	PT151323

TRADITIONAL HANDHAKCULTIVATOR



Art. Nr.	Verpakking	Code steel
PT0334010	1	PT151321

TRADITIONAL HANDCULTIVATOR 1T



Art. Nr.	Verpakking	Code steel
PT0351260	1	PT151321



TRADITIONAL HANDCULTIVATOR 3T



Art. Nr.	Verpakking	Code steel
PT0350260	1	PT151320



TRADITIONAL HANDCULTIVATOR 3T LANG HANDVAT



Art. Nr.	Verpakking	Code steel
PT0350261	1	PT151323
 5 410685 883747		



TRADITIONAL HANDWIEDVORK 2T



Art. Nr.	Verpakking	Code steel
PT0335031	1	PT151321
 5 410685 873830		



TRADITIONAL HANDWIEDVORK 2T LANG HANDVAT



Art. Nr.	Verpakking	Code steel
PT03350311	5	PT151323
 5 410685 878545		



TRADITIONAL HANDWIEDVORK 3T



Art. Nr.	Verpakking	Code steel
PT0335030	1	PT151321
 5 410685 871065		



TRADITIONAL HANDWIEDVORK 3T LANG HANDVAT



Art. Nr.	Verpakking	Code steel
PT03350301	5	PT151323
 5 410685 878514		

TRADITIONAL HANDWIEDVORK 3 PLATTE TAND



Art. Nr.	Verpakking	Code steel
PT0335032	1	PT151321
 5 410685 883198		

TRADITIONAL ONKRUIDSTEKER



Art. Nr.	Verpakking	Code steel
PT035021	1	PT151322

TRADITIONAL ONKRUIDSTEKER M/ST 1,5M



Art. Nr.	Verpakking	Code steel
PT0350211	1	141455

TRADITIONAL HANDVOEGENKRABBER LANG HANDVAT



Art. Nr.	Verpakking	Code steel
PT035045	1	PT151323

TRADITIONAL VOEGENKRABBER M/ST 1,5M



Art. Nr.	Verpakking	Code steel
PT0350221	1	PT143650

TRADITIONAL U-SCHOFFELHAK 140MM



Art. Nr.	Verpakking	Code steel
PT1231061	1	PT151321



TRADITIONAL U-SCHOFFELHAK 140MM M/ST 1,5M



Art. Nr.	Verpakking	Code steel
PT1232101	1	PT143650



TRADITIONAL ASPERGESTEKER



Art. Nr.	Verpakking	Code steel
PT035031	1	PT151322
 5 410685 874943		



TRADITIONAL ASPERGESTEKER LANG 60CM



Art. Nr.	Verpakking	Code steel
PT035032	1	PT151322
 5 410685 885987		



TRADITIONAL STRIBBELMES



Art. Nr.	Verpakking	Code steel
PT035061	1	-
 5 410685 883082		

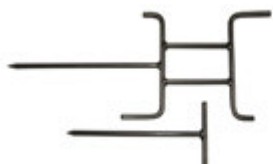

TRADITIONAL HOFKOORDOPROLLER MET T-PIN



Art. Nr.	Verpakking	Code steel
PT10091	1	-
 5 410685 871355		

TRADITIONAL COMPOSTVERLUCHTER (INOX)



Art. Nr.	Verpakking	Code steel
PT360000	1	-
 5 410685 873618		

PLANTERS

TRADITIONAL BLOEMBOLLENPLANTER 80MM



Art. Nr.	Verpakking	Code steel
PT070200	1	-

TRADITIONAL AARDAPPEL-BOLLENPLANTER 75MM



Art. Nr.	Verpakking	Code steel
PT070208	1	-

TRADITIONAL AARDAPPEL-BOLLENPLANTER 95MM



Art. Nr.	Verpakking	Code steel
PT070210	1	-

TRADITIONAL AARDAPPEL-BOLLENPLANTER 115MM



Art. Nr.	Verpakking	Code steel
PT070212	1	-

TRADITIONAL AARDAPPEL-BOLLENPLANTER 130MM



Art. Nr.	Verpakking	Code steel
PT070213	1	-

TRADITIONAL AARDAPPEL-BOLLENPLANTER 150MM



Art. Nr.	Verpakking	Code steel
PT070215	1	-

TRADITIONAL BAMBOUSTOKPLANTER



Afmeting	Art. Nr.	Verpakking	Code steel
12MM	PT070812	1	-
14MM	PT070814	1	-
16MM	PT070816	1	-
18MM	PT070818	1	-
20MM	PT070820	1	-
22MM	PT070822	1	-
25MM	PT070825	1	-
28MM	PT070828	1	-
30MM	PT070830	1	-

HOUT- EN BOSGEREEDSCHAP

TRADITIONAL HANDBIJL KLEIN MODEL M/ST 40CM



Art. Nr.	Verpakking	Code steel
PT060301	1	PT141310

TRADITIONAL HANDBIJL GROOT MODEL M/ST 40CM



Art. Nr.	Verpakking	Code steel
PT060302	1	PT141310

TRADITIONAL VELDBIJL LANGE M/ST HICKORY 90CM



Art. Nr.	Verpakking	Code steel
PT060402	1	PT141392H

TRADITIONAL HAKBIJL KLEIN M/ST 100CM



Art. Nr.	Verpakking	Code steel
PT060303	1	PT141300

TRADITIONAL KLIEFHAMER M/ST 95CM



Hickory Wood



Product	Art. Nr.	Verpakking	Code steel	Gewicht kg	
45MM 3KG	PT060430	1	PT141995	2	
50MM 3.8KG	PT060431	1	PT141995	2	
55MM 4.5KG	PT060432	1	PT141995	2	

TRADITIONAL BIJLHOUWHEEL KLEIN



Art. Nr.	Verpakking	Code steel
PT060504	1	-

TRADITIONAL BIJLHOUWHEEL KLEIN M/ST ES 110CM



Art. Nr.	Verpakking	Code steel
PT060503	1	PT151502



TRADITIONAL BIJLHOUWHEEL GROOT



Art. Nr.	Verpakking	Code steel
PT060502	1	-



TRADITIONAL BIJLHOUWHEEL GROOT M/ST ES 110CM



Art. Nr.	Verpakking	Code steel
PT060501	1	PT151502
 5 410685 871010		



TRADITIONAL KAPMES KLEIN



Art. Nr.	Verpakking	Code steel
PT061220	5	PT141320
 5 410685 869567		



TRADITIONAL KAPMES GROOT



Art. Nr.	Verpakking	Code steel
PT061230	5	PT141320
 5 410685 869574		

TRADITIONAL KAPMES RONDE SNEDE 3MM



Art. Nr.	Verpakking	Code steel
PT061240	1	PT141320
 5 410685 871041		



BOUW

GRONDBOREN

TRADITIONAL GRONDBOOR



Afmeting	Art. Nr.	Verpakking	Code steel	
80MM	PT021208	1	-	 5410685871133
110MM	PT021210	1	-	 5410685050095
125MM	PT021213	1	-	 5410685050101

TRADITIONAL GRONDBOOR



Afmeting	Art. Nr.	Verpakking	Code steel	
160MM	PT021216	1	-	 5410685050118
180MM	PT021218	1	-	 5410685871140
200MM	PT021220	1	-	 5410685052952

TRADITIONAL BOORSCHHELP



Afmeting	Art. Nr.	Verpakking	Code steel	
80MM	PT021308	1	-	 5410685872840
110MM	PT021310	1	-	 5410685872857
130MM	PT021313	1	-	 5410685876367

TRADITIONAL VERLENGBUIS GRONDBOOR



Afmeting	Art. Nr.	Verpakking	Code steel
250MM	PT021201	1	-
500MM	PT021203	1	-
1000MM	PT021202	1	-

TRADITIONAL RATEL VOOR GRONDBOOR



Art. Nr.	Verpakking	Code steel
PT021204	1	-



TRADITIONAL TREKVEER VOOR KREKELSTUK



Art. Nr.	Verpakking	Code steel
PT021205	1	-



TRADITIONAL STEUNLAT 60CM VOOR KREKELSTUK

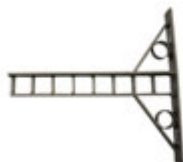

Art. Nr.	Verpakking	Code steel
PT021260	1	-



TRADITIONAL STEUNLAT 90CM VOOR KREKELSTUK

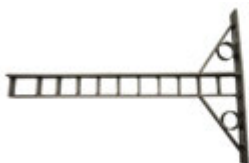



Art. Nr.	Verpakking	Code steel
PT021290	1	-



DALLENHAMERS



TRADITIONAL DALLENHAMER HOUTEN BLOK Ø85MM



Art. Nr.	Verpakking	Code steel
PT022000	1	PT151500
		
5 410685 873151		



TRADITIONAL RING VOOR DALLENHAMER HOUT



Art. Nr.	Verpakking	Code steel
PTR022000	1	-
		
5 410685 878675		



TRADITIONAL DALLENHAMER ERTALON BLOK Ø85MM



Art. Nr.	Verpakking	Code steel
PT022001	1	-
		
5 410685 871218		



TRADITIONAL DALLENHAMER HOUT+LANGE STEEL 1,8M



Art. Nr.	Verpakking	Code steel
PT022004	1	PT132180
		
5 410685 873885		

TRADITIONAL DALLENHAMER ERTALON+LANGE STEEL 1,8M







Art. Nr.	Verpakking	Code steel
PT022005	1	PT132180
		
5 410685 875032		

HEFBOMEN





TRADITIONAL KASSEIHEFBOOM 1,25M BEITEL 25MM + ERTALON 60MM



Art. Nr.	Verpakking	Code steel
PT025521	1	-
		  
5 410685 873052		





TRADITIONAL HEFBOOM 1,25M PUNT+SLAGDOP 60MM



Art. Nr.	Verpakking	Code steel
PT028227	1	-
 5 410685 872215		  





TRADITIONAL HEFBOOM 1,25M PUNT+SLAGDOP 80MM



Art. Nr.	Verpakking	Code steel
PT028228	1	-
 5 410685 870150		  





TRADITIONAL HEFBOOM 1,25M BEITEL+SLAGDOP 60MM



Art. Nr.	Verpakking	Code steel
PT028327	5	-
 5 410685 869482		  



TRADITIONAL HEFBOOM 1,25M BEITEL+SLAGDOP 80MM



Art. Nr.	Verpakking	Code steel
PT028328	1	-
 5 410685 869901		  



TRADITIONAL VERVANGBLOK IN ERTALON SLAGDOP 60MM



Art. Nr.	Verpakking	Code steel
PT028327D	1	-
 5 410685 870471		



TRADITIONAL VERVANGBLOK IN ERTALON SLAGDOP 80MM



Art. Nr.	Verpakking	Code steel
PT028329D	1	-
 5 410685 872932		



TRADITIONAL DALLENWIPPER



Art. Nr.	Verpakking	Code steel
PT025850	1	-
		



TRADITIONAL HEFBOOM BOL/PUNT 1,25MX28MM



Art. Nr.	Verpakking	Code steel
PT028225	1	-
		



TRADITIONAL HEFBOOM BOL/BEITEL 1,25M/28MM



Art. Nr.	Verpakking	Code steel
PT028324	1	-
		

TRADITIONAL AFBRAAKHEFBOOM 25MM MET VOET





Art. Nr.	Verpakking	Code steel
PT029010	1	-
		

ROOSTERHAAK

TRADITIONAL ROOSTERHAAK 73CM/10MM





Art. Nr.	Verpakking	Code steel
PT027001	1	-
		

SNIJMES KABELISOLATIE

TRADITIONAL SNIJMES KABELISOLATIE





Art. Nr.	Verpakking	Code steel
PTPP18001	1	-
		

PLAKTRUWELEN



TRADITIONAL PLAKTRUWEEL 270MM



Art. Nr.	Verpakking	Code steel
PT084027	1	-
 5 410685 872901		

TRADITIONAL PLAKTRUWEEL 500MM







Art. Nr.	Verpakking	Code steel
PT084050	1	-
 5 410685 872895		

STRATENMAKERSHAMERS





TRADITIONAL STRATENMAKERSHAMER 25MM



Art. Nr.	Verpakking	Code steel
PT2160025	1	PT151100
 5 410685 871959		  





TRADITIONAL STRATENMAKERSHAMER 30MM



Art. Nr.	Verpakking	Code steel
PT2160030	1	PT151100
 5 410685 871195		  





TRADITIONAL STRATENMAKERSHAMER 35MM



Art. Nr.	Verpakking	Code steel
PT2160035	2	PT151100
 5 410685 869673		  

TRADITIONAL KASSEIHAMER PORTUGES 30MM



Art. Nr.	Verpakking	Code steel
PT024125	2	151103
 5 410685 869680		  

STELLEN EN TOEBEHOREN

TRADITIONAL T-SPADESTEEL 74CM HICKORY



Art. Nr.	Verpakking	Code steel
PT131370H	1	-

TRADITIONAL T-SPADESTEEL 85CM HICKORY



Art. Nr.	Verpakking	Code steel
PT131385H	1	-

TRADITIONAL T-SPADESTEEL 95CM HICKORY



Art. Nr.	Verpakking	Code steel
PT131295H	1	-

TRADITIONAL T-SPADESTEEL 95 ES



Art. Nr.	Verpakking	Code steel
PT131295	1	-

TRADITIONAL PIJPSPADESTEEL 150CM D-HANDVAT



Art. Nr.	Verpakking	Code steel
PT132150	1	-



TRADITIONAL BOOMSPADESTEEL T-ST 85CM HICKORY



Art. Nr.	Verpakking	Code steel
PT137385	1	-



TRADITIONAL BOOMSPADESTEELE T-ST 90CM HICKORY



Art. Nr.	Verpakking	Code steel
PT137390	1	-
 5 410685 876343		



TRADITIONAL PLANTSPADESTEELE T-ST 90CM HICKORY



Art. Nr.	Verpakking	Code steel
PT137390H	1	-
 5 410685 881125		



TRADITIONAL SCHOPSTEELE IN ES GEBOGEN 130CM



Art. Nr.	Verpakking	Code steel
PT141213A	1	-
 5 410685 872796		



TRADITIONAL HANDBIJLSTEELE GEBOGEN 40CM



Art. Nr.	Verpakking	Code steel
PT141310	1	-
 5 410685 880845		



TRADITIONAL BIJLHOUWEELESTELE ES 110CM



Art. Nr.	Verpakking	Code steel
PT141311	1	-
 5 410685 871379		

TRADITIONAL KLIEFHAMERSTEELE 100CM HICKORY



Art. Nr.	Verpakking	Code steel
PT141995	1	-
 5 410685 872802		

TRADITIONAL LANDHAKSTEEL 150CM/40MM



Art. Nr.	Verpakking	Code steel
PT142540	1	-
 5 410685 871225		

TRADITIONAL HAK/RAAKSTEEL 150CM/28MM



Art. Nr.	Verpakking	Code steel
PT143650	1	-
 5 410685 873700		

TRADITIONAL KASSEIHAMERSTEEL 21CM



Art. Nr.	Verpakking	Code steel
PT151099	1	-
 5 410685 873168		

TRADITIONAL DALHAMERBLOK-METALEN RING



Art. Nr.	Verpakking	Code steel
PT151500	1	-
 5 410685 873878		

TRADITIONAL DALHAMERSTEEL 180CM



Art. Nr.	Verpakking	Code steel
PT132180	1	-
 5 410685 886175		

TRADITIONAL SCHOFFELSTEEL 150CM/30MM HILT



Art. Nr.	Verpakking	Code steel
PT1925016	1	-
 5 410685 874110		



Polet

SPADES & SCHOPPEN

Spades zijn de eerste gereedschappen die Polet, meer dan een eeuw geleden, smeedde. Ze zijn de bakermat van ons bedrijf en het paradepaardje in ons assortiment.

Een Poletspade heb je voor het leven. Logisch, want onze spades zijn gemaakt van een legering van kwalitatief hoogwaardig staal dat ook voor bulldozerbakken en ploegscharen gebruikt wordt. Ze worden gesmeed en gehard volgens de nieuwste technieken en de allerstrengste normen. Het resultaat is een sterk, flexibel en slijtvast spadeblad.

Voor het opscheppen van losse grond, zand of kiezel heb je een goede schop nodig. Naargelang de regio en het gebruik vind je heel verschillende modellen, zowel in de breedte als in de keuze van de steel. In België is de zandschop met een steel van 130 centimeter het meest gebruikt, terwijl men in Nederland eerder kiest voor een Drentse of Hollandse bats met een steel van 95 of 110 centimeter.

SPADES

SPADE MET VEER



STEELEBEVESTIGING

- vast verankerd d.m.v. klinknagel
- veerrand afgepolijst en dege-lijkt aangedrukt
- door de extra verdikking onderaan is er geen speling tussen veer en steel voor een lange levensduur
- boomspades: extra versterkingsring

BLAD

- dikte 3 - 3,5mm
- hoogwaardig gelegeerd staal, gehard op 47 tot 50 HRC*
- gehard tot aan de uitloop van de dul
- gladgepolijst voor een minimale wrijvingsweerstand
- alle bewerkingen gebeuren in verwarmde toestand, zodat alle mogelijke spanningen uit het metaal verwijderd worden

10 JAAR GARANTIE

- duurzaam spadeblad
- gehard Polet staal
- zelfslijpende
- scherpe snede
- robuuste steel
- garantie: op spadeblad, bij normaal gebruik

Info Garantie:
www.polet.eu



STEELE

- essen hout van 1^e kwaliteit
- rechtdradig
- glad gepolijst en nadien vernist of gewaxt
- ingewerkte pen, geniet en gelijmd

STEELDIAAMETER

- Ø 41mm



VOETTREDE HOEK

- gelaste hoek
- 15/15mm

OF



VOETTREDE ROND

- 10mm

SNEDE

- fijn geslepen
- correct gehard, garandeert hoge slijtvastheid

5 JAAR GARANTIE

- lichtgewicht spadeblad
- gehard Polet-staal
- zelfslijpend
- scherpe snede
- robuuste steel
- garantie: op spadeblad, bij normaal gebruik

Info Garantie:
www.polet.eu



DULSPADE



STEELDIAMETER

- Ø 39mm - Ø 41mm



STEELEBEVESTIGING

- bevestigd aan het blad d.m.v. schroef
- dul afgepolijst
- geen speling tussen dul en steel voor een lange levensduur van de steel

BLAD

- dikte 2,5 - 3mm
- hoogwaardig gelegeerd staal, gehard op 45 HRC*
- gehard tot aan de uitloop van de dul
- afwerking blad: gepolijst of epoxycoating
- gladgepolijst voor een minimale wrijvingsweerstand
- alle bewerkingen gebeuren in verwarmde toestand, zodat alle mogelijke spanningen uit het metaal verwijderd worden

SPADE MET ZWANEHALS



T-STEEL



D-STEEL



BOLSTEEL

STEELDIAMETER

- Ø 36mm

STEELEBEVESTIGING

- bevestigd d.m.v. klinknagel
- zwanehals afgepolijst
- geen speling tussen dul en steel voor een lange levensduur van de steel

BLAD

- dikte 2,5mm – 3mm
- hoogwaardig gelegeerd staal, gehard op 47 tot 50 HRC*
- afwerking blad: gepolijst of epoxycoating
- gladgepolijst voor een minimale wrijvingsweerstand
- alle bewerkingen gebeuren in verwarmde toestand, zodat alle mogelijke spanningen uit het metaal verwijderd worden

*HRC = Hardness Rockwell C

GLASVEZELSTELEN

Een **glasvezelsteel** is uit miljoenen haarfijne glasvezels getrokken en door middel van een epoxyhars uitgehard in een microwave, zodat er geen luchtbelvorming tussen de vezels zit. Hierdoor worden in de lengte gebarsten stelen uitgesloten.



**3x
STERKER
DAN HOUT**



FIBER 3001

HOLLE FIBER

- glasvezelversterkte polyamide steel
- lichte, holle steel die 2 tot 3 maal sterker is dan een houten steel
- gebruik: schoppen, batsen en bezems

**5x
STERKER
DAN HOUT**



FIBER 5001

FIBER KERN

- glasvezelkern omringd door PVC
- gebruik: assortiment van spades, voorhamers, klassieke hamers, hak- en kloofbijlen

**10x
STERKER
DAN HOUT**



FIBER 9001

VOLLE FIBER

- homogeen getrokken glasvezel, 100% parallel en continu
- gebruik: assortiment van professionele spades en hamers

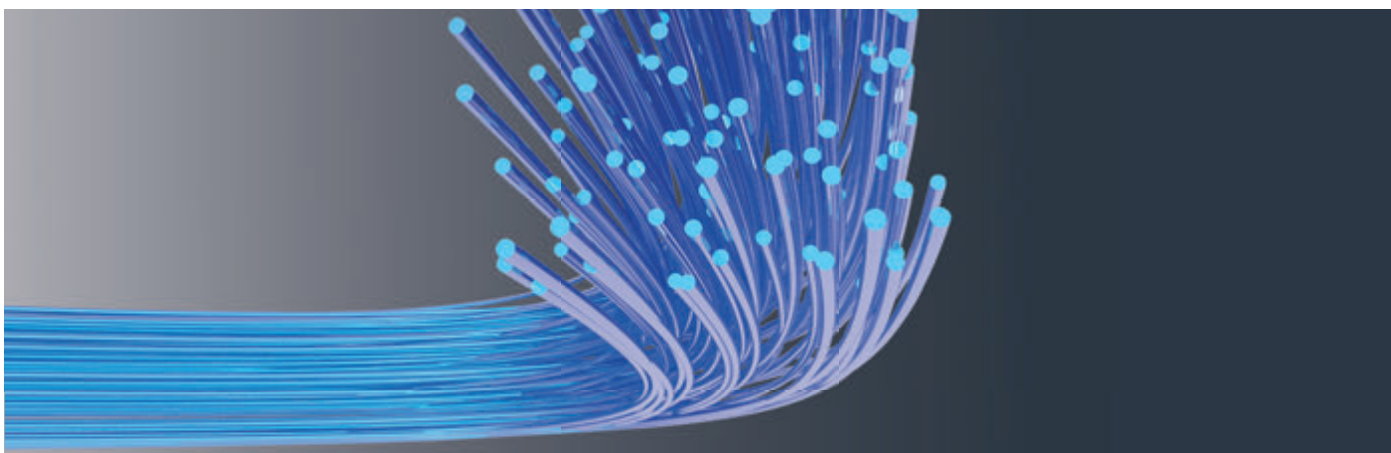
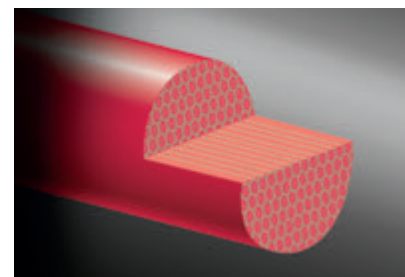
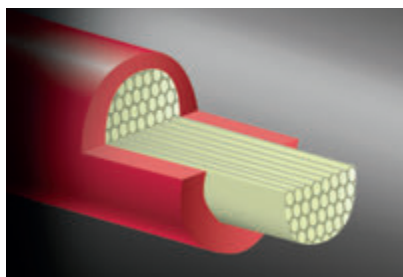

BEKIJK DE TEST

VIA DE QR CODE OF OP
WWW.YOUTUBE.COM/POLETQUALITYPRODUCTS









PLANT- EN BOOMSPADES PROFESSIONAL

BLADDIKTE 3,5MM







PROF.PLANTSPADE 280/180/3,5 2V T-ST FIBER 9001 95CM



Art. Nr.	Verpakking	Code steel
101007F	1	SHT36
 5 410685 010952	     	







PROF.PLANTSPADE 280/180/3,5 D-ST FIBER 9001 95CM



Art. Nr.	Verpakking	Code steel
102007F	1	SHT36D
 5 410685 800232	    	







PROF.PLANTSPADE 280/180/3,5 2V BOL FIBER 9001 105CM



Art. Nr.	Verpakking	Code steel
103007F	5	SHT43
 5 410685 800683	     	







PROF.PLANTSPADE 280/180/3,5 2V T-ST FIBER 5001 95CM



Art. Nr.	Verpakking	Code steel
101007E	5	EESPA95
 5 410685 884126	     	







PROF.PLANTSPADE 280/180/3,5 2V T-ST FIBER 5001 105CM



Art. Nr.	Verpakking	Code steel
101007EB	5	EESPABV
 5 410685 884133	     	

PROF.PLANTSPADE 280/180/3,5 T-ST 95CM



Art. Nr.	Verpakking	Code steel
101007	5	137295
 5 410685 010945	    	

PROF.Boomspade 350/180/3,5 2V T-ST FIBER 9001 85CM



Art. Nr.	Verpakking	Code steel
101010F	1	SHT32

PROF.Boomspade 350/130/3,5 2V T-ST FIBER 9001 85CM



Art. Nr.	Verpakking	Code steel
101005F	1	SHT32

PROF.Boomspade 350/130/3,5 D-ST FIBER 9001 85CM



Art. Nr.	Verpakking	Code steel
102005F	1	SHT32D

PROF.Boomspade 350/130/3,5 2V BOL FIBER 9001 105CM



Art. Nr.	Verpakking	Code steel
101004F	1	SHT43

PROF.Boomspade 350/130/3,5 2V T-ST FIBER 5001 85CM



Art. Nr.	Verpakking	Code steel
101005E	5	EESPA

PROF.Boomspade 350/130/3,5 2V T-ST FIBER 5001 105CM



Art. Nr.	Verpakking	Code steel
101005EB	5	EESPABV

PROF. BOOMSPADE 350/130/3,5 T-ST 85CM



Art. Nr.	Verpakking	Code steel
101005	5	137285

GRONDWERKSPADES PROFESSIONAL

BLADDIKTE 3MM

PROF. GRONDWERKSPADE 380/140/3 2V T-ST FIBER 5001 85CM



Art. Nr.	Verpakking	Code steel
101384E	5	EESPA

PROF. GRONDWERKSPADE 380/140/3 T-ST 85CM



Art. Nr.	Verpakking	Code steel
101384	5	131285

PROF. GRONDWERKSPADE 380/140/3 D-ST 85CM



Art. Nr.	Verpakking	Code steel
102384	5	132285

PROF. GRONDWERKSPADE 420/130/3 2V T-ST FIBER 5001 85CM



Art. Nr.	Verpakking	Code steel
101423E	5	EESPA

PROF. GRONDWERKSPADE 420/130/3 T-ST 85CM



Art. Nr.	Verpakking	Code steel
101423	5	131285

PROF.GRONDWERKSPADE 470/130/3 2V T-ST 70CM



Art. Nr.	Verpakking	Code steel
101473	5	131370

PROF.GRONDWERKSPADE 470/130/3 LI.V T-ST 70CM



Art. Nr.	Verpakking	Code steel
101471	5	131370

PROF.GRONDWERKSPADE 470/130/3 RE.V T-ST 70CM



Art. Nr.	Verpakking	Code steel
101472	5	131370

GRONDWERKSPADES

BLADDIKTE 2,5MM

GRONDWERKSPADE 380/140/2,5 2V T-ST 85CM



Art. Nr.	Verpakking	Code steel
107384	5	131285

TUINSPADES PROFESSIONAL

BLADDIKTE 3MM

PROF.SPADE 280/180/3 2V T-ST FIBER 5001 95CM



Art. Nr.	Verpakking	Code steel
102007E	5	EESPA95

PROF.SPADE 280/180/3 2V T-ST 95CM



Art. Nr.	Verpakking	Code steel
102007V	5	131295

PROF.SPADE 280/180/3 T-ST 95CM



Art. Nr.	Verpakking	Code steel
102007	5	131295

PROF.SPADE 280/180/3 D-ST 90CM



Art. Nr.	Verpakking	Code steel
102006	5	132390

PROF.SPADE 280/180/3 B-ST 100CM



Art. Nr.	Verpakking	Code steel
103007	5	133305

EPOXY-SPADE 280/180/3 T-ST 95CM



Art. Nr.	Verpakking	Code steel
102007G	5	131295

PROF.SPADE 285/180/3 2V T-ST FIBER 5001 95CM



Art. Nr.	Verpakking	Code steel
106110EV	2	EESPA95

PROF.TUINSPADE 285/180/3 2V T-ST 95CM



Art. Nr.	Verpakking	Code steel
106110V	5	135396

PROF.TUINSPADE 285/180/3 2V B-ST 105CM



Art. Nr.	Verpakking	Code steel
106110BV	5	133396

PROF.SPADE 320/160/3 2V T-ST FIBER 9001 95CM



Art. Nr.	Verpakking	Code steel
101326F	5	SHT36LD

PROF.SPADE 320/160/3 2V T-ST FIBER 5001 95CM



Art. Nr.	Verpakking	Code steel
101326E	5	EESPA95

PROF.SPADE 320/160/3 2V B-ST FIBER 5001 105CM



Art. Nr.	Verpakking	Code steel
103326E	5	EESPAB

PROF.SPADE 320/160/3 2V T-ST 95CM



Art. Nr.	Verpakking	Code steel
101326V	5	131295

PROF.SPADE 320/160/3 2V B-ST 100CM



Art. Nr.	Verpakking	Code steel
103326V	5	133305

PROF.SPADE 320/160/3 T-ST 95CM



Art. Nr.	Verpakking	Code steel
101326	5	131295

PROF.SPADE 320/160/3 B-ST 100CM



Art. Nr.	Verpakking	Code steel
103326	5	133305

PROF.SPADE 340/140/3 2V WEST VLAANDEREN T-ST 95CM



Art. Nr.	Verpakking	Code steel
101344	5	131295

PROF.SPADE 340/140/3 WEST VLAANDEREN D-ST 90CM



Art. Nr.	Verpakking	Code steel
102344	5	132390

PROF.SPADE 350/160/3 T-ST 95CM



Art. Nr.	Verpakking	Code steel
101356	5	131295

PROF.SPADE 350/160/3 D-ST 90CM



Art. Nr.	Verpakking	Code steel
102356	5	132390

PROF.SPADE 400/140/3 T-ST 85CM



Art. Nr.	Verpakking	Code steel
101404	5	131285

PROF.SPADE 400/140/3 D-ST 85CM



Art. Nr.	Verpakking	Code steel
102404	5	132285

PROF.SPADE SENLIS 280/180/3 2V T-ST FIBER 5001 95CM



Art. Nr.	Verpakking	Code steel
101288E	5	EESPA95

PROF.SPADE SENLIS 280/180/3 2V B-ST FIBER 5001 105CM



Art. Nr.	Verpakking	Code steel
103288E	5	EESPAB

PROF.SPADE SENLIS 280/180/3 2V T-ST 95CM



Art. Nr.	Verpakking	Code steel
101288V	5	131295

PROF.SPADE SENLIS 280/180/3 2V B-ST 100CM



Art. Nr.	Verpakking	Code steel
103288V	5	133305

PROF.SPADE SENLIS 280/180/3 T-ST 95CM



Art. Nr.	Verpakking	Code steel
101288	5	131295

TUINSPADES

BLADDIKTE 2,5MM

SPADE 280/180/2,5 2V T-ST FIBER 5001 95CM



Art. Nr.	Verpakking	Code steel
107007E	5	EESPA95

SPADE 280/180/2,5 2V T-ST FIBER 3001 95CM



Art. Nr.	Verpakking	Code steel
FH102007V	5	FH131395

SPADE 280/180/2,5 T-ST FIBER 3001 95CM



Art. Nr.	Verpakking	Code steel
FH102007	5	FH131395

SPADE 280/180/2,5 T-ST 95CM



Art. Nr.	Verpakking	Code steel
107007	5	131295

SPADE 280/180/2,5 B-ST 115CM



Art. Nr.	Verpakking	Code steel
109007	5	133305

SPADE 285/180/2,5 T-ST 95CM



Art. Nr.	Verpakking	Code steel
107110	5	135396

SPADE 285/180/2,5 B-ST 105CM



Art. Nr.	Verpakking	Code steel
107110B	5	133396

SPADE 320/160/2,5 T-ST 95CM



Art. Nr.	Verpakking	Code steel
107326	5	131295

SPADE CHARLEROI 320/160/2,5 T-ST 95CM



Art. Nr.	Verpakking	Code steel
108326	5	131395

SPADE LUIK/NAMEN 320/160/2,5 B-ST 100CM







Art. Nr.	Verpakking	Code steel
109326	5	133305

SPADES MET MASSIEVE ZWANENHALSDUL







PROF.SPADE ZH 280/150/160 T-ST FIBER 5001 75CM



Art. Nr.	Verpakking	Code steel
101018E	5	EESHT29SS
 5 410685 011102		   





PROF.SPADE ZH 280/150/160 2V T-ST FIBER 5001 75CM



Art. Nr.	Verpakking	Code steel
101018EV	5	EESHT29SS
 5 410685 858127		    







PROF.SPADE ZH 280/150/165 T-ST 75CM



Art. Nr.	Verpakking	Code steel
101028	5	1920010
 5 410685 054444		   







PROF.SPADE ZH 280/150/165 2V T-ST 75CM



Art. Nr.	Verpakking	Code steel
101028V	5	1920010
 5 410685 858103		    







PROF.KABELSPADE ZH 320/135 2V T-ST FIBER 5001 75CM



Art. Nr.	Verpakking	Code steel
101009E	5	EESHT29SS
 5 410685 011089		    

PROF.KABELSPADE ZH 320/135 2V T-ST 75CM



Art. Nr.	Verpakking	Code steel
101020	5	1920010
 5 410685 801512		    

PROF.KABELSPADE ZH 320/135 2V EPOXY T-ST 75CM



Art. Nr.	Verpakking	Code steel
101009	5	1920010

PROF.SPADE ZH 280/170 EPOXY T-ST FIBER 5001 75CM



Art. Nr.	Verpakking	Code steel
101008E	5	EESHT29SS

SPADE ZH 280/170 EPOXY T-ST 75CM



Art. Nr.	Verpakking	Code steel
107008	5	1920010

SPADES MET OPEN DUL

SPADE NOORD FRANKRIJK 280/155/2,5 2V T-ST 90CM



Art. Nr.	Verpakking	Code steel
101285	5	136290

SPADE WALLONIE 280/150/2,5 T-ST 90CM



Art. Nr.	Verpakking	Code steel
101280	5	136290

DAMESSPADE 280/150/2,5 T-ST FIBER 3001 90CM



Art. Nr.	Verpakking	Code steel
FH101001	5	FH136290

DAMESSPADE 280/150/2,5 T-ST 90CM



Art. Nr.	Verpakking	Code steel
101001	5	136290

DAMESSPADE 280/150/2,5 OPEN DUL B-ST 115CM



Art. Nr.	Verpakking	Code steel
103001	5	136305

DULSPADE LIMBURG 260/180/2,5



Art. Nr.	Verpakking	Code steel
100268	5	-

DULSPADE LIMBURG 260/180/2,5 B-ST 115CM



Art. Nr.	Verpakking	Code steel
103268	5	136305

DULSPADE ANTWERPEN 270/180/2,5



Art. Nr.	Verpakking	Code steel
100278	5	-

DULSPADE ANTWERPEN 270/180/2,5 T-ST 95CM



Art. Nr.	Verpakking	Code steel
101278	5	139285

DULSPADE ANTWERPEN 270/180/2,5 B-ST 115CM



Art. Nr.	Verpakking	Code steel
103278	5	136305

TUINSPADE 260/160 GEPOLIJST T-ST 90CM



BUDGET

Art. Nr.	Verpakking	Code steel
ECO266T	5	132390CB

TUINSPADE 260/160 GEPOLIJST B-ST 105CM



BUDGET

Art. Nr.	Verpakking	Code steel
ECO266B	5	136305CB

SPADE 280/150 T-ST 90CM



BUDGET

Art. Nr.	Verpakking	Code steel
ECO285V	5	136290CB

SPADE 280/150 B-ST 105CM



BUDGET

Art. Nr.	Verpakking	Code steel
ECO285VB	5	136305CB

SPADE SENLIS 280/180 T-ST 90CM





BUDGET

Art. Nr.	Verpakking	Code steel
ECO288T	5	136290CB

SPADE SENLIS 280/180 B-ST 105CM





Art. Nr.	Verpakking	Code steel
ECO288B	5	136305CB
 5 410685 011515		

ROESTVRIJSTALEN SPADES-RVS



SPADE 280/180 INOX T-ST 95CM



Art. Nr.	Verpakking	Code steel
102008	5	131295
 5 410685 011249		



TUINSPADE 280/150 INOX T-ST FIBER 3001 90CM



Art. Nr.	Verpakking	Code steel
FH101002	5	FH136290
 5 410685 854969		

TUINSPADE 280/150 INOX T-ST OPEN DUL 90CM



Art. Nr.	Verpakking	Code steel
101002	5	136290
 5 410685 010563		



SCHOPPEN & BATSEN

STEEL

- hout van 1^e kwaliteit
- gemodelleerde vorm en buiging volgens DIN20151

STEELDIAMETER

- Ø 41mm

BLAD

- gepolijst, zwart gelakt of epoxy-coating
- extra gehard op 47 tot 50 HRC*
- gehard tot aan de uitloop van de dul

SNEDE

- aangeslepen snede

STEEL

- hout van 1ste kwaliteit

STEEL

- fiber 3001, glasvezelversterkte polyamide

BLAD

- aluminium



STEEL

- fiber 3001, glasvezelversterkte polyamide tot 3x sterker dan hout

BLAD

- gepolijst of zwart gelakt
- gehard op 45 HRC*
- aangeslepen snede



DULSTANDEN		TOEPASSINGEN
	20mm - recht (stekend)	Drentse batsen
	35mm - half gebogen (halfstekend - half scheppend)	Drentse batsen
	70mm - extra opstaand (scheppend - holle bats) Standaard dulstand 70 mm tenzij anders vermeld.	Schoppen

AFMETINGEN			
TYPE	LENGTE	BREEDTE	TOEPASSINGEN
2	290mm	240mm	Zandschop
1	290mm	230mm	Zandschop
0	290mm	220mm	Betonschop
00	265mm	220mm	Zandschop / Bats
000	255mm	210mm	Bats

*HRC = Hardness Rockwell C

ZANDSCHOPPEN

PROF.ZANDSCHOP NR00-265X220MM



Art. Nr.	Verpakking	Code steel
110206	10	-

PROF.ZANDSCHOP NR00 MET GEWAXTE ESSEN STEEL 130CM



Art. Nr.	Verpakking	Code steel
110216S	5	141213

PROF.ZANDSCHOP NR00 FIBER 3001 130CM



Art. Nr.	Verpakking	Code steel
FH110216	1	FH141213

PROF.ZANDSCHOP NR00 GEPOLIJST-265X220MM



Art. Nr.	Verpakking	Code steel
110206A	1	-

PROF.ZANDSCHOP NR00 GEPOLIJST MET GEWAXTE ESSEN STEEL 130CM



Art. Nr.	Verpakking	Code steel
110216A	1	141213

ZANDSCHOP NR00 MET GEBOGEN STEEL 130CM



Art. Nr.	Verpakking	Code steel
110226	5	142213

PROF.ZANDSCHOP NR1-290X230MM



Art. Nr.	Verpakking	Code steel
110201	10	-

PROF.ZANDSCHOP NR1 MET GEWAXTE ESSEN STEEL 130CM



Art. Nr.	Verpakking	Code steel
110211S	5	141213

PROF.ZANDSCHOP NR1 FIBER 3001 130CM



Art. Nr.	Verpakking	Code steel
FH110211	1	FH141213

PROF.ZANDSCHOP NR1 GEPOLIJST-290X230MM



Art. Nr.	Verpakking	Code steel
110201A	5	-

PROF.ZANDSCHOP NR1 GEPOLIJST MET GEWAXTE ESSEN STEEL 130CM



Art. Nr.	Verpakking	Code steel
110211A	1	141213

ZANDSCHOP NR1 MET GEBOGEN STEEL 130CM



Art. Nr.	Verpakking	Code steel
110221	5	142213

PROF.ALU ZANDSCHOP NR2-290X240MM



Art. Nr.	Verpakking	Code steel
110202AL	10	-
 5 410685 869413		

PROF.ALU ZANDSCHOP NR2 MET GEWAXTE ESSEN STEEL 130CM



Art. Nr.	Verpakking	Code steel
110212AL	5	141213
 5 410685 869437		

PROF.ALU ZANDSCHOP NR2 FIBER 3001 130CM



Art. Nr.	Verpakking	Code steel
110212ALF	5	FH141213
 5 410685 869444		

PROF.ZANDSCHOP NR2-290X240MM



Art. Nr.	Verpakking	Code steel
110202	10	-
 5 410685 020029		

PROF.ZANDSCHOP NR2 MET GEWAXTE ESSEN STEEL 130CM



Art. Nr.	Verpakking	Code steel
110212S	5	141213
 5 410685 020104		

PROF.ZANDSCHOP NR2 FIBER 3001 130CM



Art. Nr.	Verpakking	Code steel
FH110212	5	FH141213
 5 410685 854938		

PROF.ZANDSCHOP NR2 GEPOLIJST-290X240MM



Art. Nr.	Verpakking	Code steel
110202A	1	-

PROF.ZANDSCHOP NR2 GEPOLIJST MET GEWAXTE ESSEN STEEL 130CM



Art. Nr.	Verpakking	Code steel
110212A	1	141213

ZANDSCHOP NR2 MET GEBOGEN STEEL 130CM



Art. Nr.	Verpakking	Code steel
110222	5	142213

ZANDSCHOP NR2 PROMO MET GEBOGEN STEEL 130CM



Art. Nr.	Verpakking	Code steel
110212P	5	141213P

ZANDSCHOP NR2 MET GEBOGEN STEEL 130CM



Art. Nr.	Verpakking	Code steel
110222P	5	141213P

KABELSCHOPPEN

PROF.KABELSCHOP 120/290MM



Art. Nr.	Verpakking	Code steel
110312	10	-

PROF.KABELSCHOP 120/290MM M/ST 130CM



Art. Nr.	Verpakking	Code steel
1103121	5	141213

PROF.KABELSCHOP 120/290MM FIBER 3001 130CM



Art. Nr.	Verpakking	Code steel
FH1103121	1	FH141213

PROF.KABELSCHOP 140/290MM



Art. Nr.	Verpakking	Code steel
110314	10	-

PROF.KABELSCHOP 140/290MM M/ST 130CM



Art. Nr.	Verpakking	Code steel
1103141	5	141213

PROF.KABELSCHOP 140/290MM FIBER 3001 130CM



Art. Nr.	Verpakking	Code steel
FH1103141	1	FH141213

PROF.KABELSCHOP 160/290MM



Art. Nr.	Verpakking	Code steel
110316	10	-

PROF.KABELSCHOP 160/290MM M/ST 130CM



Art. Nr.	Verpakking	Code steel
1103161	5	141213

PROF.KABELSCHOP 160/290MM FIBER 3001 130CM



Art. Nr.	Verpakking	Code steel
FH1103161	1	FH141213

PROF.KABELSCHOP 180/290MM



Art. Nr.	Verpakking	Code steel
110318	10	-

DRENTSE BATSEN

GEPOLIJST

PROF.BATS DRENTS 00/35 GEPOLIJST



Art. Nr.	Verpakking	Code steel
112203	10	-

PROF.BATS DRENTS 00/35 GEPOLIJST T-ST 100CM



Art. Nr.	Verpakking	Code steel
112223	5	141611

PROF.BATS DRENTS 00/35 GEPOLIJST T-ST 110CM



Art. Nr.	Verpakking	Code steel
112243	5	1911002

PROF.BATS DRENTS 00/35 GEPOLIJST T-ST FIBER 3001 95CM



Art. Nr.	Verpakking	Code steel
FH112223	1	FH141611

PROF.BATS DRENTS 00/35 GEPOLIJST T-ST FIBER 3001 110CM



Art. Nr.	Verpakking	Code steel
FH112243	1	FH1911002

PROF.BATS DRENTS 00/35 GEPOLIJST 2V



Art. Nr.	Verpakking	Code steel
112203V	10	-

PROF.BATS DRENTS 00/35 GEPOLIJST 2V T-ST 100CM



Art. Nr.	Verpakking	Code steel
112223V	5	141611



PROF.BATS DRENTS 00/35 GEPOLIJST 2V T-ST 110CM



Art. Nr.	Verpakking	Code steel
112243V	5	1911002



PROF.BATS DR 00/35 GEPOLIJST 2V T-ST-ST FIBER 3001 95CM



Art. Nr.	Verpakking	Code steel
FH112223V	1	FH141611
		 



PROF.BATS DR 00/35 GEPOLIJST 2V T-ST FIBER 3001 110CM



Art. Nr.	Verpakking	Code steel
FH112243V	1	FH1911002
		 



PROF.BATS DRENTS 000/35 GEPOLIJST



Art. Nr.	Verpakking	Code steel
112302	10	-
		



PROF.BATS DRENTS 000/35 GEPOLIJST T-ST 100CM



Art. Nr.	Verpakking	Code steel
112322	5	141611
		 



PROF.BATS DRENTS 000/35 GEPOLIJST T-ST 110CM



Art. Nr.	Verpakking	Code steel
112342	5	1911002
		 



PROF.BATS DRENTS 000/35 GEPOLIJST T-ST FIBER 3001 95CM



Art. Nr.	Verpakking	Code steel
FH112322	1	FH141611
		 



PROF.BATS DR 000/35 GEPOLIJST T-ST FIBER 3001 110CM



Art. Nr.	Verpakking	Code steel
FH112342	1	FH1911002
 5 410685 868263		





PROF.BATS DRENTS 000/35 GEPOLIJST 2V



Art. Nr.	Verpakking	Code steel
112302V	10	-
 5 410685 862544		





PROF.BATS DRENTS 000/35 GEPOLIJST 2V T-ST 100CM



Art. Nr.	Verpakking	Code steel
112322V	5	141611
 5 410685 862513		  





PROF.BATS DRENTS 000/35 GEPOLIJST 2V T-ST 110CM



Art. Nr.	Verpakking	Code steel
112342V	5	1911002
 5 410685 862537		  





PROF.BATS DR 000/35 GEPOLIJST 2V T-ST FIBER 3001 95CM



Art. Nr.	Verpakking	Code steel
FH112322V	1	FH141611
 5 410685 875933		  

PROF.BATS DR 000/35 GEPOLIJST 2V T-ST FIBER 3001 110CM



Art. Nr.	Verpakking	Code steel
FH112342V	1	FH1911002
 5 410685 868270		  

ZWART GELAKT

BATS DRENTS 00/35



Art. Nr.	Verpakking	Code steel
111104	10	-

PROF.BATS DRENTS 00/35 T-ST 100CM



Art. Nr.	Verpakking	Code steel
111253	5	141611

BATS DRENTS 00/35 T-ST 110CM



Art. Nr.	Verpakking	Code steel
111285	5	1911002

PROF.BATS DRENTS 00/35 T-ST FIBER 3001 95CM



Art. Nr.	Verpakking	Code steel
FH111253	5	FH141611

PROF.BATS DRENTS 00/35 T-ST FIBER 3001 110CM



Art. Nr.	Verpakking	Code steel
FH111243	5	FH1911002

BATS DRENTS 00/35 2V



Art. Nr.	Verpakking	Code steel
111104V	10	-

PROF.BATS DRENTS 00/35 2V T-ST 100CM



Art. Nr.	Verpakking	Code steel
111253V	5	141611

BATS DRENTS 00/35 2V T-ST 110CM



Art. Nr.	Verpakking	Code steel
111285V	1	1911002

PROF.BATS DR 00/35 2V T-ST 95CM FIBER 3001



Art. Nr.	Verpakking	Code steel
FH111253V	5	FH141611

PROF.BATS DR 00/35 2V T-ST 110CM FIBER 3001



Art. Nr.	Verpakking	Code steel
FH111243V	5	FH1911002

BATS DRENTS 000/35 ZWART



Art. Nr.	Verpakking	Code steel
111105	1	-

BATS DRENTS 000/35 ZWART T-ST 95CM



Art. Nr.	Verpakking	Code steel
111115	5	141621

BATS DRENTS 000/35 ZWART T-ST 110CM



Art. Nr.	Verpakking	Code steel
111116	5	1911022

PROF.BATS DR 000/35 ZWART T-ST FIBER 3001 95CM



Art. Nr.	Verpakking	Code steel
FH111115	5	FH141611

PROF.BATS DRENTS 000/35 T-ST FIBER 3001 110CM



Art. Nr.	Verpakking	Code steel
FH111116	5	FH1911002

BATS DRENTS 000/35 ZWART 2V



Art. Nr.	Verpakking	Code steel
111105V	1	-

BATS DRENTS 000/35 ZWART 2V T-ST 95CM



Art. Nr.	Verpakking	Code steel
111115V	5	141621



BATS DRENTS 000/35 ZWART 2V T-ST 110CM



Art. Nr.	Verpakking	Code steel
111116V	5	1911022



PROF.BATS DR 000/35 2V T-ST FIBER 3001 95CM



Art. Nr.	Verpakking	Code steel
FH111115V	5	FH141611
 5 410685 882825		



PROF.BATS DR 000/35 2V T-ST FIBER 3001 110CM



Art. Nr.	Verpakking	Code steel
FH111116V	5	FH1911002
 5 410685 882832		



BATS DRENTS 00/20 ZWART



Art. Nr.	Verpakking	Code steel
111102	10	-
 5 410685 020319		



BATS DRENTS 00/20 ZWART T-ST 110CM



Art. Nr.	Verpakking	Code steel
111122	5	139285
 5 410685 020401		

BATS DRENTS 00/20 ZWART T-ST FIBER 3001 110CM





Art. Nr.	Verpakking	Code steel
FH111122	5	FH1911002
 5 410685 885529		

GRIJS GELAKT

BATS DRENTS 00/35 T-ST 100CM



Art. Nr.	Verpakking	Code steel
111245P	1	141621
 5 410685 870754		

BATS DRENTS 00/35 T-ST 110CM



Art. Nr.	Verpakking	Code steel
111243P	1	1911002

BATS DRENTS 000/35 T-ST 100CM



Art. Nr.	Verpakking	Code steel
111246P	5	141611

BATS DRENTS 000/35 T-ST 110CM



Art. Nr.	Verpakking	Code steel
111247P	5	1911002

BETONSCHOPPEN

BETONSCHOP MET RECHTE HOEKEN

PROF.BETONSCHOP 290X220



Art. Nr.	Verpakking	Code steel
110501	10	-

PROF.BETONSCHOP 290X220 M/ST 130CM



Art. Nr.	Verpakking	Code steel
110511S	5	141213

PROF.BETONSCHOP 290X220 FIBER 3001 130CM



Art. Nr.	Verpakking	Code steel
FH110511	5	FH141213

PROF.BETONSCHOP 290X220 T-ST 110CM



Art. Nr.	Verpakking	Code steel
110551	5	191122

PROF.BETONSCHOP 290X220 FIBER 3001 T-ST 110CM



Art. Nr.	Verpakking	Code steel
FH110551	1	FH1911002



BETONSCHOP MET AFGERONDE HOEKEN

BETONSCHOP 290X220



Art. Nr.	Verpakking	Code steel
110505B	5	-

BETONSCHOP 290X220 M/ST 130CM



Art. Nr.	Verpakking	Code steel
110554	5	141213P

BETONSCHOP MOD HOLLSTEIN

PROF.BETONSCHOP NR0 250X230MM



Art. Nr.	Verpakking	Code steel
110600	1	-

PROF.BETONSCHOP NR0 250X230 T-ST 95CM



Art. Nr.	Verpakking	Code steel
110652	5	141611

PROF.BETONSCHOP NR0 250X230 T-ST 110CM



Art. Nr.	Verpakking	Code steel
110651	5	1911022

PROF.BETONSCHOP NR2 265X250MM



Art. Nr.	Verpakking	Code steel
110602	10	-

PROF.BETONSCHOP NR2 M/ST 130CM



Art. Nr.	Verpakking	Code steel
110612S	5	141213



PROF.BETONSCHOP NR2 M/ST FSC 100% 130CM



Art. Nr.	Verpakking	Code steel
110612SS	5	141213



PROF.BETONSCHOP NR2 FIBER 3001 130CM



Art. Nr.	Verpakking	Code steel
FH110612	5	FH141213
 5 410685 807750		



PROF.BETONSCHOP NR2 T-ST 110CM



Art. Nr.	Verpakking	Code steel
110662	5	1911002
 5 410685 021514		



BETONSCHOP 265X250 T-ST 110CM



Art. Nr.	Verpakking	Code steel
110612IP	5	1911022
 5 410685 810743		

PROF.BETONSCHOP NR2 FIBER 3001 T-ST 110CM





Art. Nr.	Verpakking	Code steel
FH110662	1	FH1911002
 5 410685 868454		

ZWANEHALSSCHOPPEN



PROF. ZWANEHALSSCHOP VIERKANT 290X250X220



Art. Nr.	Verpakking	Code steel
110425	10	-
 5 410685 838495		

PROF. ZWANEHALSSCHOP VIERKANT 290X250X220 M/ST 130CM



Art. Nr.	Verpakking	Code steel
110425S	5	141223
 5 410685 838501		

PROF. ZWANEHALSSCHOP VIERKANT 290X250X220 FIBER 3001 130CM



Art. Nr.	Verpakking	Code steel
FH110425	1	FH141223

ZWANEHALSSCHOP VIERKANT 290X250X220 M/ST BEUK 130CM



Art. Nr.	Verpakking	Code steel
110425P	1	142223

PROF. ZWANEHALSSCHOP ROND 270X270



Art. Nr.	Verpakking	Code steel
110427	10	-

PROF. ZWANEHALSSCHOP ROND 270X270 M/ST 130CM



Art. Nr.	Verpakking	Code steel
110427S	5	141223

PROF. ZWANEHALSSCHOP ROND 270X270MM FIBER 3001 130CM



Art. Nr.	Verpakking	Code steel
FH110427	5	FH141223

ZWANEHALSSCHOP ROND 270MM M/ST BEUK 130CM



Art. Nr.	Verpakking	Code steel
110427P	1	141223

FRANKFURTERSCHOPPEN

PROF. FRANKFURTERSCHOP NR5 300X270



Art. Nr.	Verpakking	Code steel
110701	10	-

PROF. FRANKFURTERSCHOP 300X270 M/ST 130CM



Art. Nr.	Verpakking	Code steel
110711S	5	141213

PROF. FRANKFURTERSCHOP 300X270 FIBER 3001 130CM



Art. Nr.	Verpakking	Code steel
FH110711	5	FH141213

PROF. SCHOP FOXPOINT B-ST FIBER 3001 150CM



Art. Nr.	Verpakking	Code steel
110800F	1	-

BALLASTSCHOPPEN

BALLASTSCHOP NR2 320X260 D-ST 95CM



Art. Nr.	Verpakking	Code steel
1060402	3	141452

BALLASTSCHOP NR4 340X280 D-ST 95CM



Art. Nr.	Verpakking	Code steel
1060404	5	141452

ALUMINIUM SCHOPPEN

ZONDER SLIJTSTRIP



BALLASTSCHOP
• Alu 340 x 280



GRAANSCHOP
• Alu 410 x 330

GRAANSCHOP
• 410 x 330 mm
• 500 x 360 mm

MET SLIJTSTRIP



BALLASTSCHOP
• 340 x 280 mm
• 440 x 360 mm

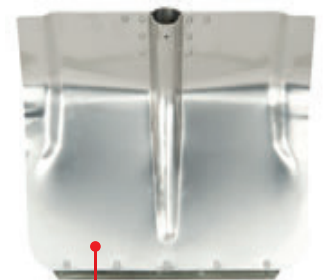

KOLENSCHOP
• 360 x 410 mm

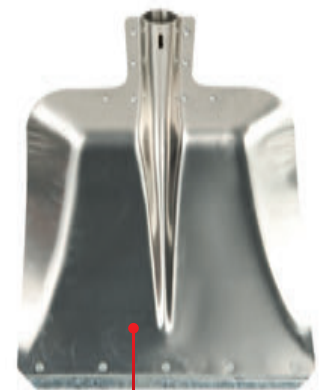

RANDSCHOP
• 380 x 380 mm

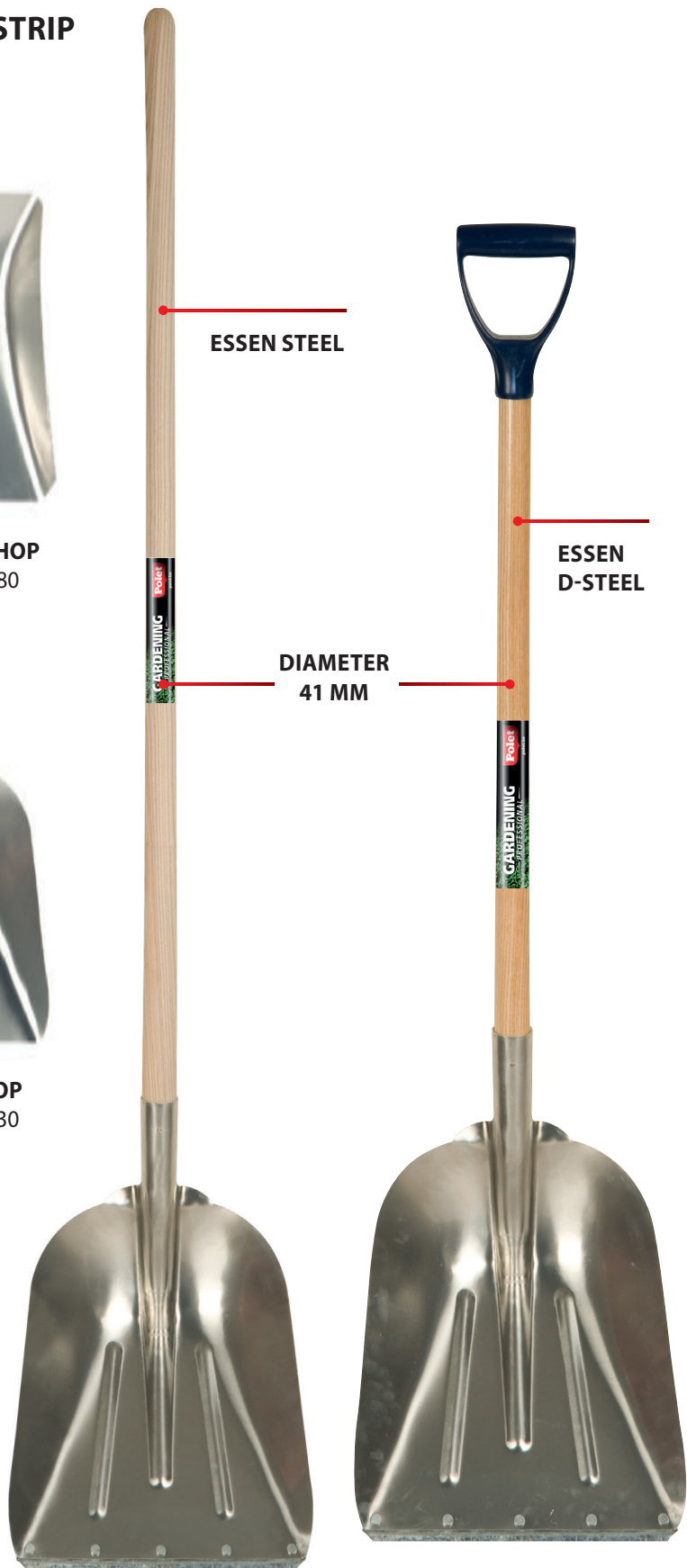

ESSEN STEEL

ESSEN
D-STEEL

DIAMETER
41 MM

GEPROFILEERDE
STALEN SLIJTSTRIP





ALUMINIUM SCHOPPEN

BALLASTSCHOPPEN



BALLASTSCHOP ALU 340X280



Art. Nr.	Verpakking	Code steel
335000	3	-
 5 410685 020821		



BALLASTSCHOP ALU 340X280 M/ST 130CM



Art. Nr.	Verpakking	Code steel
335100	3	141223
 5 410685 805046		



BALLASTSCHOP ALU 340X280 D-ST 95CM



Art. Nr.	Verpakking	Code steel
335100D	3	141450
 5 410685 020845		



BALLASTSCHOP ALU 340X280 T-ST FIBER 3001 95CM



Art. Nr.	Verpakking	Code steel
335100FT	5	FH141611
 5 410685 886618		



BALLASTSCHOP ALU 340X280 MET SLIJTSTRIP



Art. Nr.	Verpakking	Code steel
335000V	3	-
 5 410685 020838		

BALLASTSCHOP ALU 340X280 MET SLIJTSTRIP M/ST 130CM



Art. Nr.	Verpakking	Code steel
335100V	3	141223
 5 410685 805312		

BALLASTSCHOP ALU 340X280 MET SLIJTSTRIP M/ST FIBER 3001 130CM



Art. Nr.	Verpakking	Code steel
335100F	1	141223F

BALLASTSCHOP ALU 340X280 MET SLIJTSTRIP D-ST 95CM



Art. Nr.	Verpakking	Code steel
335100VD	3	141450

BALLASTSCHOP ALU 380X380 M/ST 130CM



Art. Nr.	Verpakking	Code steel
3320001E	5	141213P

BALLASTSCHOP ALU 440X360 MET SLIJTSTRIP



Art. Nr.	Verpakking	Code steel
336000V	3	-

BALLASTSCHOP ALU 440X360 MET SLIJTSTRIP M/ST 130CM



Art. Nr.	Verpakking	Code steel
336100V	3	141223

BALLASTSCHOP ALU 440X360 MET SLIJTSTRIP D-ST 95CM



Art. Nr.	Verpakking	Code steel
336100VD	3	141450

RANDSCHOPPEN, MET SLIJTSTRIP

RANDSCHOP ALU 380X380 MET SLIJTSTRIP



Art. Nr.	Verpakking	Code steel
332000	3	-

RANDSCHOP ALU 380X380 MET SLIJTSTRIP M/ST 130CM



Art. Nr.	Verpakking	Code steel
332100	3	141213

RANDSCHOP ALU 380X380 MET SLIJTSTRIP D-ST 95CM



Art. Nr.	Verpakking	Code steel
332100D	3	141449

GRAANSCHOPPEN

GRAANSCHOP ALU 410X330



Art. Nr.	Verpakking	Code steel
331000	3	-

GRAANSCHOP ALU 410X330 M/ST 130CM



Art. Nr.	Verpakking	Code steel
331100	3	141223

GRAANSCHOP ALU 410X330 M/ST FIBER 3001 130CM



Art. Nr.	Verpakking	Code steel
331100F	3	FH141223

GRAANSCHOP ALU 410X330 D-ST 95CM



Art. Nr.	Verpakking	Code steel
331100D	3	141450

GRAANSCHOP ALU 410X330 M/ST BEUK 130CM



Art. Nr.	Verpakking	Code steel
331100P	1	142223

GRAANSCHOP ALU 410X330 MET SLIJTSTRIP



Art. Nr.	Verpakking	Code steel
331000V	3	-

GRAANSCHOP ALU 410X330 MET SLIJTSTRIP M/ST 130CM



Art. Nr.	Verpakking	Code steel
331100V	3	141223

GRAANSCHOP ALU 410X330 MET SLIJTSTRIP M/ST FIBER 3001 130CM



Art. Nr.	Verpakking	Code steel
331100VF	3	FH141223

GRAANSCHOP ALU 410X330 MET SLIJTSTRIP D-ST 95CM



Art. Nr.	Verpakking	Code steel
331100VD	3	141450

GRAANSCHOP ALU 500X360 MET SLIJTSTRIP



Art. Nr.	Verpakking	Code steel
330000V	3	-

GRAANSCHOP ALU 500X360 MET SLIJTSTRIP M/ST 130CM



Art. Nr.	Verpakking	Code steel
330100V	3	141223

GRAANSCHOP ALU 500X360 MET SLIJTSTRIP M/ST FIBER 3001 130CM



Art. Nr.	Verpakking	Code steel
330100VF	3	FH141223

GRAANSCHOP ALU 500X360 MET SLIJTSTRIP D-ST 95CM



Art. Nr.	Verpakking	Code steel
330100VD	3	141450

KOLENSCHOPPEN, MET SLIJTSTRIP

KOLENSCHOP ALU 360X410 MET SLIJTSTRIP



Art. Nr.	Verpakking	Code steel
333000	3	-

KOLENSCHOP ALU 360X410 MET SLIJTSTRIP M/ST 130CM



Art. Nr.	Verpakking	Code steel
333100	3	141213

KOLENSCHOP ALU 360X410 MET SLIJTSTRIP D-ST 95CM



Art. Nr.	Verpakking	Code steel
333100D	3	141450

SLIJTSTRIPPEN

SLIJTSTRIP ALU SCHOP



Afmeting	Art. Nr.	Verpakking	Code steel	
240MM	STRIP240	1	-	 5410685022245
310MM	STRIP310	1	-	 5410685022252
360MM	STRIP360	1	-	 5410685022269

SNEEUWSCHOPPEN-SNEEUWSCHUIVERS

SNEEUWSCHOP PROF. 520MM ALU D-ST 115CM



Art. Nr.	Verpakking	Code steel
347050	1	-

SNEEUWSCHUIVER POLYP. 430MM M/ST 130CM



Art. Nr.	Verpakking	Code steel
343002	5	143662

SNEEUWSCHUIVER POLYP. 430MM D-ST 1,4M



Art. Nr.	Verpakking	Code steel
343003	5	143640

SNEEUWSCHOP POLYP. 400MM M/ST 130CM



Art. Nr.	Verpakking	Code steel
344002	5	143662

SNEEUWSCHUIVER ALU 400MM M/ST 130CM



Art. Nr.	Verpakking	Code steel
345001	5	141453

POLYSCHOP POLYP.+ALU STRIP 420X370 M/ST 130CM



Art. Nr.	Verpakking	Code steel
347040	1	142213



SNEEWSCHUIVER ABS 500MM D-ST 115CM



Art. Nr.	Verpakking	Code steel
347001	1	143640

SNEEWSCHOP ABS 410MM D-ST 115CM



Art. Nr.	Verpakking	Code steel
347002	1	143640

SNEEWSCHOP POLYP. 400MM TELESCOPISCHE STEEL 80-130CM



Art. Nr.	Verpakking	Code steel
347000TL	1	143700AL

SNEEUWSCHOP POLYP. 400MM D-ST 140CM



Art. Nr.	Verpakking	Code steel
347000D	5	143640

STALSCHRAPER

STALSCHRAPER 350MM



Art. Nr.	Verpakking	Code steel
341000	3	-

STALSCHRAPER 350MM M/ST 130CM



Art. Nr.	Verpakking	Code steel
3410001	3	141453

STALSCHRAPER GEGALVANISEERD 500MM



Art. Nr.	Verpakking	Code steel
341100	1	-

STALSCHRAPER GEGALVANISEERD 500MM M/ST 130CM



Art. Nr.	Verpakking	Code steel
3411001	3	141223







STALSCHRAPER GEHARD 500MM



Art. Nr.	Verpakking	Code steel
341200	3	-

STALSCHRAPER GEHARD 500MM M/ST 130CM



Art. Nr.	Verpakking	Code steel
3412001	3	141453
 5 410685 869475	    	



Polet

GARDENING

Doeltreffend en aangepast tuingereedschap verhoogt het tuinplezier en verlicht het werk.

Daarom ontwerpen wij bij Polet gereedschap met een lange levensduur en een zo groot mogelijk gebruiksgemak.

In onze productie gebruiken wij enkel hoogwaardig staal en we voorzien de gereedschappen van een steel uit eerste klas hout.

RIEKEN & VORKEN

MESTRIEK

- 3, 4 of 5 ronde tanden
- dient om afval of mest op te scheppen of om de composthoop om te zetten

**GLASVEZEL-
VERSTERKTE
POLYAMIDE STEEL**

- tot 3 x sterker dan houten steel

STEEL

- essen hout van 1^e kwaliteit
- gevernist

RIEK

- epoxy coating
- gesmede tanden, gehard

LIPDUL

VEERBUS

DUL

DUL

LIPDUL

VEERBUS

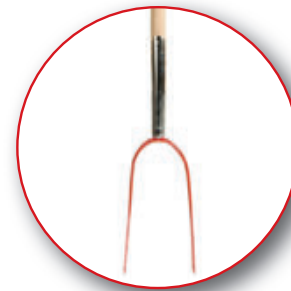

HOOIVORK

- 2 tanden



SPITVORK

- 4 platte tanden
- excellent alternatief voor een spade
- handig bij het spitten tussen struiken en in borders. Beschadigt de wortels minder snel
- werkt veel lichter dan een spade
- alternatief om de bodem te verluchten en om de composthoop om te zetten

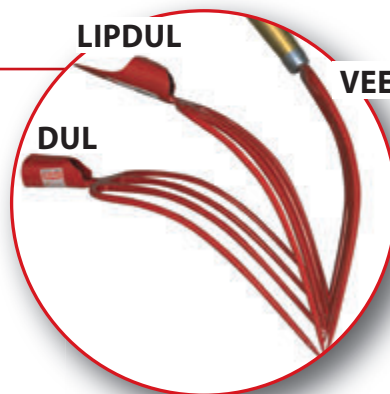

RIEKEN EN VORKEN

RIEKEN MET DUL

MESTRIEK DUL 3T 320X200MM



Art. Nr.	Verpakking	Code steel
303000	5	-

MESTRIEK DUL 3T 320X200MM M/ST 130CM



Art. Nr.	Verpakking	Code steel
303010	5	141213A

MESTRIEK DUL 4T 320X220MM

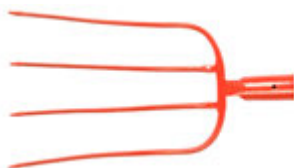

Art. Nr.	Verpakking	Code steel
304000	5	-

MESTRIEK DUL 4T 320X220MM M/ST 130CM



Art. Nr.	Verpakking	Code steel
304010	5	141213A

MESTRIEK DUL 4T 320X220MM M/ST FIBER 3001 130CM



Art. Nr.	Verpakking	Code steel
FH304135	5	FH141213



MESTRIEK DUL 4T 320X220MM T-ST 100CM



Art. Nr.	Verpakking	Code steel
304010T	5	141611



MESTRIEK DUL 4T 320X220MM T-ST GEBOGEN FIBER 3001 110CM



Art. Nr.	Verpakking	Code steel
FH304135T	5	FH1911002
		



MESTRIEK 4T MET PROMO STEEL 130CM



Art. Nr.	Verpakking	Code steel
304010B	5	141213P
		



AARDAPPELSTEEKRIEK 4T 320X200MM B-ST 130CM



Art. Nr.	Verpakking	Code steel
30400BP	5	141213
		



AARDAPPELSTEEKRIEK 4T 320X200MM T-ST 100CM



Art. Nr.	Verpakking	Code steel
30400TP	5	141611
		

AARDAPPELSTEEKRIEK 4T 320X200MM FIBER 3001 130CM



Art. Nr.	Verpakking	Code steel
FH30400BP	5	FH141213
		

RIEKEN MET LIPDUL

MESTRIEK LIPDUL 4T 320X220MM



Art. Nr.	Verpakking	Code steel
304001	5	-

MESTRIEK LIPDUL 4T 320X220MM M/ST 130CM



Art. Nr.	Verpakking	Code steel
304011	5	141213A

MESTRIEK LIPDUL 4T 320X220MM T-ST 100CM



Art. Nr.	Verpakking	Code steel
304011T	5	141611

MESTRIEK LIPDUL 4T 320X220MM D-ST 95CM



Art. Nr.	Verpakking	Code steel
304001D	5	141449

MESTRIEK LIPDUL 5T 320X250MM

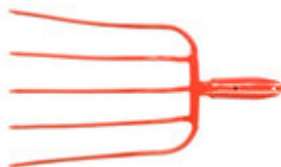

Art. Nr.	Verpakking	Code steel
305001	5	-

MESTRIEK LIPDUL 5T 320X250MM M/ST 130CM



Art. Nr.	Verpakking	Code steel
305011	5	141213A

MESTRIEK LIPDUL 5T 320X250MM T-ST 100CM



Art. Nr.	Verpakking	Code steel
305011T	5	141611

MESTRIEK LIPDUL 5T 320X250MM D-ST 95CM



Art. Nr.	Verpakking	Code steel
305001D	5	141449

RIEKEN MET VEERBUSSTEEL

MESTRIEK 4T 320X220MM VEERBUS T-ST 85CM



Art. Nr.	Verpakking	Code steel
304000T	5	141499

MESTRIEK 4T 320X220MM M/ST VEERBUS 130CM



Art. Nr.	Verpakking	Code steel
304135	5	142412

MESTRIEK 4T M/ST VEERBUS 130CM



Art. Nr.	Verpakking	Code steel
304135E	5	142412

MESTRIEK 5T 320X250MM VEERBUS T-ST 85CM



Art. Nr.	Verpakking	Code steel
305000T	5	141499

MESTRIEK 5T 320X250MM M/ST VEERBUS 130CM



Art. Nr.	Verpakking	Code steel
305135	5	142412

SPITHAKEN-MESTHAKEN-CULTIVEERHAKEN

SPITHAAK DUL 4T 250X180MM



Art. Nr.	Verpakking	Code steel
304301	3	-

SPITHAAK DUL 4T 250X180MM M/ST 130CM



Art. Nr.	Verpakking	Code steel
304301B	3	141223

MESTHAAK DUL 4T 260X210MM



Art. Nr.	Verpakking	Code steel
314000	3	-

MESTHAAK DUL 4T 260X210MM M/ST 130CM



Art. Nr.	Verpakking	Code steel
314010	3	141223

MESTHAAK DUL 4T 260X210MM M/ST BEUK 1,3M



Art. Nr.	Verpakking	Code steel
314010P	1	142223

MESTHAAK DUL 5T 160X200MM



Art. Nr.	Verpakking	Code steel
314005	3	-

MESTHAAK DUL 5T 160X200MM M/ST 130CM



Art. Nr.	Verpakking	Code steel
3140051	3	141223

CULTIVEERHAAK 4T 130X200MM



Art. Nr.	Verpakking	Code steel
314002	3	-

CULTIVEERHAAK 4T 130X200MM M/ST 130CM



Art. Nr.	Verpakking	Code steel
3140021	3	141223

CULTIVEERHAAK 3T 120X90MM M/ST 130CM



Art. Nr.	Verpakking	Code steel
314003	3	141453K

TUINKRAUWEL

TUINKRAUWEL 4T



Art. Nr.	Verpakking	Code steel
035030	5	-

TUINKRAUWEL 4T M/ST 1,5M



Art. Nr.	Verpakking	Code steel
0350301	5	143650

HOOIVORKEN MET VEERBUSSTEEEL

HOOIVORK 2T M/ST VEERBUS 150CM



Art. Nr.	Verpakking	Code steel
302150	3	141455K

HOOIVORK 2T M/ST VEERBUS 165CM



Art. Nr.	Verpakking	Code steel
302165	3	141456K

SPITVORKEN MET DUL

SPITVORK DUL 4T 300X180MM



Art. Nr.	Verpakking	Code steel
304300	5	-

SPITVORK DUL 4T 300X180MM T-ST 95CM



Art. Nr.	Verpakking	Code steel
304300T	5	141611

SPITVORK 4T 300X180MM T-ST FIBER 3001 95CM



Art. Nr.	Verpakking	Code steel
FH304100	5	FH141611

SPITVORK DUL 4T 300X180MM B-ST 115CM



Art. Nr.	Verpakking	Code steel
304300B	5	136305

SPITVORK 4T 300X180MM B-ST FIBER 3001 130CM



Art. Nr.	Verpakking	Code steel
FH304300B	1	FH141223

BORDERVORK 3T M/ST 60CM







Art. Nr.	Verpakking	Code steel
303100	1	131360



SPITVORKEN MET VEERBUSSTEEL





SPITVORK 4T 280X180MM VEERBUS T-ST 85CM



Art. Nr.	Verpakking	Code steel
304100E	5	141499
 5 410685 070321		   





SPITVORK 4T 280X180MM VEERBUS D-ST 85CM



Art. Nr.	Verpakking	Code steel
304200	5	141449K
 5 410685 070314		   

SPITVORK 4T VEERBUS T-ST 95CM



Art. Nr.	Verpakking	Code steel
304500E	5	141499
 5 410685 800645		   

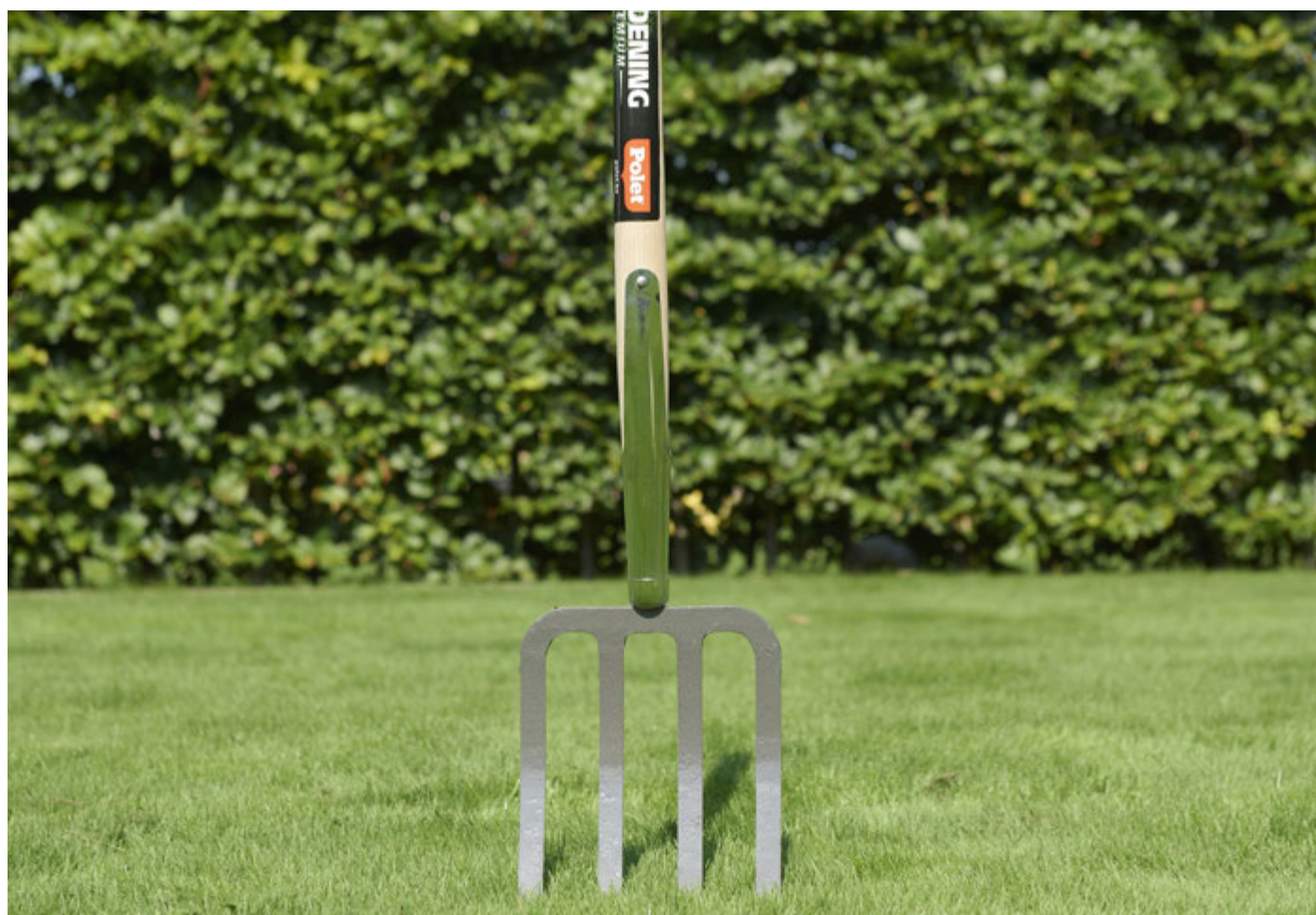

WOELVORKEN



WOELVORK

- populair bij de ecologische tuinier
- grond verluchten zonder het ondergronds biologisch evenwicht te verstoren
- ergonomisch
- gemakkelijk
- efficiënt
- verandert de bodemstructuur niet
- beschadigt de wortels niet
- maakt de bodem los en luchtig



BEKIJK DE GEBRUIKSVIDEO

VIA DE QR CODE OF OP

WWW.YOUTUBE.COM/POLETQUALITYPRODUCTS

HOE WERKT EEN WOELVORK?

- 1) Steek de tanden van de woelvork in de grond en duw ze met je voet dieper.
- 2) Ga één stap achteruit en trek aan de armen of buis de woelvork naar je toe tot die in een hoek van 60 tot 45 graden staat.
- 3) Indien nodig beweeg je met de woelvork van links naar rechts. Dit is niet nodig bij de dubbele woelvork.
- 4) Ga opnieuw een stap achteruit en trek de woelvork nu ook achteruit en herhaal vanaf stap 1.

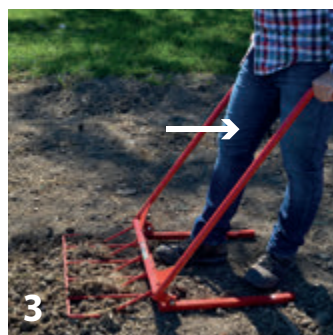

DUBBELE WOELVORK

- Voor ecologisch tuinieren: belucht de bodem zonder het microbiologisch evenwicht te verstoren.
- Met 2 rijen tanden, 9 in totaal, om grond te verluchten zonder te keren.



TUINKLAUW

- moestuin & siertuin
- aarde losmaken
- grond beluchten
- onkruid wieden
- minder belastend voor de rug



BEKIJK DE GEBRUIKSVIDEO

VIA DE QR CODE OF OP

WWW.YOUTUBE.COM/POLETQUALITYPRODUCTS



BEKIJK DE GEBRUIKSVIDEO

VIA DE QR CODE OF OP





WWW.YOUTUBE.COM/POLETQUALITYPRODUCTS

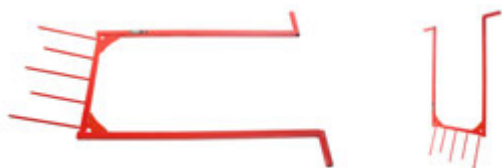

WOELVORKEN





WOELVORK 5T / 520MM



Art. Nr.	Verpakking	Code steel
072000	1	-
 5 410685 868386		  





DUBBELE WOELVORK 5T



Art. Nr.	Verpakking	Code steel
073000	1	-
 5 410685 887653		  





ERGO TUINKLAUW MET VOETSTEUN



Art. Nr.	Verpakking	Code steel
074000	1	-
 5 410685 888322		  

TUINWOELER



Art. Nr.	Verpakking	Code steel
2041	2	-
 5 410685 864807		  

COMPOST

COMPOSTWOELER



Art. Nr.	Verpakking	Code steel
360001	5	-

- compost beluchten
- compost mengen
- ergonomisch voor de rug
- eenvoudig in gebruik

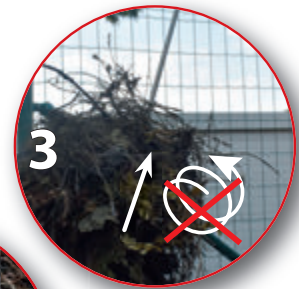

**INOX SPIRAAL
ROEST NIET**

COMPOSTVERLUCHTER



Art. Nr.	Verpakking	Code steel
360000	5	-



LANDBOUWRIEKEN MET LIPDUL

BIETENRIEK 6T 360X285MM

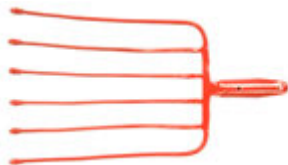

Art. Nr.	Verpakking	Code steel
306000	3	-

BIETENRIEK 6T 360X285MM D-STEEL 95CM



Art. Nr.	Verpakking	Code steel
306200	3	141449

MAISRIEK 6T 370X285MM

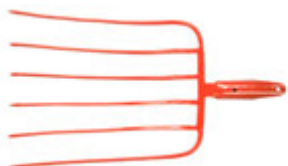

Art. Nr.	Verpakking	Code steel
306001	3	-

MAISRIEK 6T 370X285MM D-STEEL 95CM



Art. Nr.	Verpakking	Code steel
306201	3	141449

AARDAPPELRIEK 10T 360X290MM

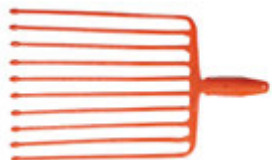

Art. Nr.	Verpakking	Code steel
310000	3	-

AARDAPPELRIEK 10T 360X290MM D-STEEL 95CM



Art. Nr.	Verpakking	Code steel
310200	3	141449

STEENRIEKEN-PUINRIEKEN

STEENRIEK 9T 350X270MM

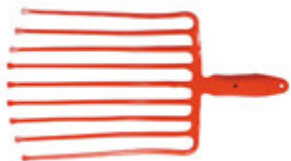

Art. Nr.	Verpakking	Code steel
309000	3	-

STEENRIEK 9T 350X270MM M/ST 130CM



Art. Nr.	Verpakking	Code steel
309100	3	141213A

STEENRIEK 9T 350X270MM D-ST 95CM



Art. Nr.	Verpakking	Code steel
309200	3	141449

STEENRIEK 9T 350X270MM T-ST 95 FIBER 3001 95CM



Art. Nr.	Verpakking	Code steel
309300	1	FH141611

STALVORKEN

STALVORK METAAL 20T 380X270MM

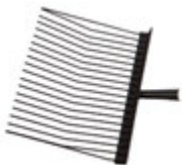

Art. Nr.	Verpakking	Code steel
350045	5	-

STALVORK METAAL 20T 380X270MM M/ST 1,5M



Art. Nr.	Verpakking	Code steel
3500451	5	143662

STALVORK ABS 16T 310X420MM



Art. Nr.	Verpakking	Code steel
350025	1	-

STALVORK ABS 16T 310X420MM M/ST 1,5M



Art. Nr.	Verpakking	Code steel
3500251	1	143662

STALVORK+KORF ABS 16T 310X420MM



Art. Nr.	Verpakking	Code steel
350035	1	-

STALVORK+KORF ABS 16T 310X420MM M/ST 1,5M



Art. Nr.	Verpakking	Code steel
3500351	1	143662

STALVORK+KORF ABS 16T 310X420MM D-ST 1,4M



Art. Nr.	Verpakking	Code steel
3500351D	1	143640/151212

KUNSTSTOFRIEK 327X395MM



Art. Nr.	Verpakking	Code steel
FB82NC	1	-

KUNSTSTOFRIEK 327X395MM M/ST 135CM



Art. Nr.	Verpakking	Code steel
FB82NC1	1	143666

PAARDENSTALVORK 10T HOUTEN D-ST 120CM



Art. Nr.	Verpakking	Code steel
3500462	1	-

PAARDENSTALVORK 10T DUBBEL HOUTEN D-ST 120CM



Art. Nr.	Verpakking	Code steel
3500472	1	-

STALVORKEN

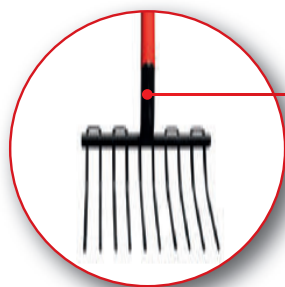

- uitmesten en opstrooien van de stallen
- schuift gemakkelijker onder vertrappeld en samengeklit strooisel
- handig in de tuin om compost te verwerken
- gemakkelijk grote brokken/stenen opvissen



**IDEAAL VOOR
GEBRUIK OP
RUBBEREN MATTEN!**

- uitmesten en opstrooien van de stallen
- schuift gemakkelijker onder vertrappeld en samengeklit strooisel
- beschadigt de rubberen mat niet dankzij de afgeronde tanden



HAKKEN

HAKKEN & SCHOFFELS

WORTELS VAN ONKRUID VERWIJDEREN
DE GROND OPPERVLAKKIG LOS MAKEN

- ergonomisch
- fijn geslepen snede
- gesmeed blad



HAK
SCHAAF-
MODEL



SCHOFFEL
LIMBURG

BETUWE
SCHOFFEL

VENLO
SCHOFFEL

- duwende beweging



BEUGELHAK

BIETENHAK

TUINHAK

WESTLANDHAK

- trekkende beweging
- conisch gevormde dul
- gehard 47-50 HRC*
- hoge slijtvastheid
- fijn geslepen snede
- gesmeed blad



BEUGELHAK 160X40MM



Art. Nr.	Verpakking	Code steel
031016	5	-

BEUGELHAK 160X40MM M/ST 1,5M



Art. Nr.	Verpakking	Code steel
0310161	5	143662

BEUGELHAK 160X40MM M/ST 1,5M



Art. Nr.	Verpakking	Code steel
0310171	5	143662

BEUGELHAK 160MM



BUDGET

Art. Nr.	Verpakking	Code steel
031016E	5	-

BEUGELHAK 160MM M/ST 1,5M



BUDGET

Art. Nr.	Verpakking	Code steel
0310161E	5	143650

HAK SCHAAFMODEL 160MM



Art. Nr.	Verpakking	Code steel
031018	1	-

HAK SCHAAFMODEL 160MM M/ST 1,5M



Art. Nr.	Verpakking	Code steel
0310181	1	143662



BIETENHAK



Afmeting	Art. Nr.	Verpakking	Code steel	
160x80MM	036016	5	-	 5410685030325
180x95MM	036018	5	-	 5410685030332

BIETENHAK M/ST 1,5M



Afmeting	Art. Nr.	Verpakking	Code steel	
160x80MM	0360161	5	143662	 5410685030394
180x95MM	0360181	5	143662	 5410685030400

BIETENHAK 160X80MM EPOXY



Art. Nr.	Verpakking	Code steel
036017	5	-

BIETENHAK 160X80MM EPOXY M/ST 1,5M



Art. Nr.	Verpakking	Code steel
0360171	5	143662

TUINHAK



Afmeting	Art. Nr.	Verpakking	Code steel	
120x65MM	037012	5	-	 5410685030424
140x65MM	037014	5	-	 5410685030431
160x65MM	037016	5	-	 5410685030448
180x65MM	037018	5	-	 5410685030455

TUINHAK M/ST 1,5M



Afmeting	Art. Nr.	Verpakking	Code steel	
120x65MM	0370121	5	143662	 5410685030493
140x65MM	0370141	5	143662	 5410685030509
160x65MM	0370161	5	143662	 5410685030516
180x65MM	0370181	5	143662	 5410685030523

TUINHAK 140X65MM FIBER 3001 1,5M



Art. Nr.	Verpakking	Code steel
FH0370141	5	FH143650

TUINHAK 140X65MM EPOXY



Art. Nr.	Verpakking	Code steel
037015	5	-

TUINHAK 140X65MM EPOXY M/ST 1,5M



Art. Nr.	Verpakking	Code steel
0370151	5	143662

TUINHAK 160MM



BUDGET

Art. Nr.	Verpakking	Code steel
037016E	5	-

TUINHAK 160MM M/ST 1,5M



BUDGET

Art. Nr.	Verpakking	Code steel
0370161E	5	143650

HAKKEN MODEL NEDERLAND



WESTLANDHAK



Afmeting	Art. Nr.	Verpakking	Code steel	
140MM	1216014	5	-	 5410685032664
160MM	1216016	5	-	 5410685032671
180MM	1216018	5	-	 5410685032688
200MM	1216020	5	-	 5410685032695
220MM	1216022	5	-	 5410685032701

WESTLANDHAK M/ST 1,5M







Afmeting	Art. Nr.	Verpakking	Code steel	
140MM	12160141	5	143662	 5410685036761
160MM	12160161	5	143662	 5410685036778
180MM	12160181	5	143662	 5410685036785
200MM	12160201	5	143662	 5410685036792
220MM	12160221	5	143662	 5410685036808

SCHOFFELS





SCHOFFEL LIMBURG



Afmeting	Art. Nr.	Verpakking	Code steel	
120x52MM	039012	5	-	 5410685030707
140x52MM	039014	5	-	 5410685030714
160x52MM	039016	5	-	 5410685030721
180x52MM	039018	5	-	 5410685030738

SCHOFFEL LIMBURG M/ST 1,5M



Afmeting	Art. Nr.	Verpakking	Code steel	
120x52MM	0390121	5	143662	 5410685030790
140x52MM	0390141	5	143662	 5410685030806
160x52MM	0390161	5	143662	 5410685030813
180x52MM	0390181	5	143662	 5410685030820

SCHOFFEL LIMBURG 160X52MM FIBER 3001 1,5M



Art. Nr.	Verpakking	Code steel
FH0390161	5	FH143650
 5 410685 855058		

SCHOFFEL LIMBURG EPOXY 160X52MM



Art. Nr.	Verpakking	Code steel
039017	5	-
 5 410685 809532		

SCHOFFEL LIMBURG EPOXY 160X52MM M/ST 1,5M



Art. Nr.	Verpakking	Code steel
0390171	5	143662
 5 410685 809549		

SCHOFFEL LIMBURG EPOXY 160X52MM M/ST 1,6M HILT



Art. Nr.	Verpakking	Code steel
0390171H	5	1925096
 5 410685 886212		

SCHOFFEL 160MM



BUDGET

Art. Nr.	Verpakking	Code steel
039016E	5	-
 5 410685 032237		

SCHOFFEL 160MM M/ST 1,5M





BUDGET

Art. Nr.	Verpakking	Code steel
0390161E	5	143650
 5 410685 032268		

SCHOFFELS MODEL NEDERLAND



BETUWE SCHOFFEL



Afmeting	Art. Nr.	Verpakking	Code steel	
140MM	1212014	5	-	 5410685032480
160MM	1212016	5	-	 5410685032497
180MM	1212018	5	-	 5410685032503



BETUWE SCHOFFEL M/ST 1,5M



Afmeting	Art. Nr.	Verpakking	Code steel	
140MM	12120141	5	143662	 5410685036877
160MM	12120161	5	143662	 5410685036884
180MM	12120181	5	143662	 5410685036891

BETUWE SCHOFFEL HILTST 1,6M



Afmeting	Art. Nr.	Verpakking	Code steel	
140MM	12120141H	5	1925096	 5410685839751
160MM	12120161H	5	1925096	 5410685839768
180MM	12120181H	5	1925096	 5410685839775

BETUWE SCHOFFEL FIBER 3001 1,5M



Afmeting	Art. Nr.	Verpakking	Code steel	
160MM	FH12120161	5	FH143650	 5410685869789

VENLO SCHOFFEL 4 ZIJDIG GESLEPEN



Afmeting	Art. Nr.	Verpakking	Code steel	
140MM	1228014	5	-	 5410685801062
160MM	1228016	5	-	 5410685806920

VENLO SCHOFFEL 4 ZIJDIG M/ST 1,5M



Afmeting	Art. Nr.	Verpakking	Code steel	
140MM	12280141	5	143662	 5410685862575
160MM	12280161	5	143662	 5410685807682

VENLO SCHOFFEL 4 ZIJDIG HILTST 1,6M



Afmeting	Art. Nr.	Verpakking	Code steel	
160MM	12280161H	5	1925096	 5410685839812



HOUWELEN-LANDHAKKEN

HOUWEEL/LANDHAK



Afmeting	Art. Nr.	Verpakking	Code steel	
180x120	045002	3	-	 5410685879351
200x140	045004	3	-	 5410685031797
220x160	045000	3	-	 5410685031537

HOUWEEL/LANDHAK M/ST 1,5M



Afmeting	Art. Nr.	Verpakking	Code steel	
180x120	0450021	1	142540	 5410685879368
200x140	0450041	3	142540	 5410685031810
220x160	0450001	3	142540	 5410685031803

TUINHAKJE PUNT-SNEDE



Art. Nr.	Verpakking	Code steel
035021	5	-

TUINHAKJE PUNT-SNEDE M/ST 1,3M



Art. Nr.	Verpakking	Code steel
0350211	5	142543

TUINHAKJE VORK-SNEDE



Art. Nr.	Verpakking	Code steel
035022	5	-

TUINHAKJE VORK-SNEDE M/ST 1,3M



Art. Nr.	Verpakking	Code steel
0350221	5	142543

TUINHAKJE PUNT-SNEDE M/ST BLANK VERNIST 1,3M



Art. Nr.	Verpakking	Code steel
0350211B	1	142543

TUINHAKJE VORK-SNEDE M/ST BLANK VERNIST 1,3M



Art. Nr.	Verpakking	Code steel
0350221B	1	142543

COMBIHAK MET 3-TAND



BUDGET

Art. Nr.	Verpakking	Code steel
035021E	5	-

COMBIHAK MET 3-TAND M/ST 1,5M



BUDGET

Art. Nr.	Verpakking	Code steel
0350211E	5	143650

COMBIHAK VORK/HART



BUDGET

Art. Nr.	Verpakking	Code steel
035022E	5	-

COMBIHAK VORK/HART M/ST 1,5M



Art. Nr.	Verpakking	Code steel
0350221E	5	143650

AANAARDER 220MM



Art. Nr.	Verpakking	Code steel
030004	3	-

AANAARDER 220MM M/ST 1,5M



Art. Nr.	Verpakking	Code steel
0300041	5	143662

CULTIVATOREN

CULTIVATOR 3T VAST



Art. Nr.	Verpakking	Code steel
034023	5	-

CULTIVATOR 3T VAST M/ST 1,5M



Art. Nr.	Verpakking	Code steel
0340231	5	143662

CULTIVATOR 3T VAST M/ST FIBER 3001 1,5M



Art. Nr.	Verpakking	Code steel
FH0340231	5	FH143650

CULTIVATOR 3T



BUDGET

Art. Nr.	Verpakking	Code steel
034023E	5	-

CULTIVATOR 3T M/ST 1,5M



BUDGET

Art. Nr.	Verpakking	Code steel
0340231E	5	143650

CULTIVATOR 3T HANEPOOT



BUDGET

Art. Nr.	Verpakking	Code steel
035023	5	-

CULTIVATOR 3T HANEPOOT M/ST 1,5M



BUDGET

Art. Nr.	Verpakking	Code steel
0350231	5	143650

COMBI-CULTIVATOR



BUDGET

Art. Nr.	Verpakking	Code steel
035024	5	-

COMBI-CULTIVATOR M/ST 1,5M



BUDGET

Art. Nr.	Verpakking	Code steel
0350241	5	143650

ALTERNATIEVE ONKRUIDBESTRIJDING

Onkruidbestrijders op basis van glyfosaten horen niet meer thuis in onze tuin. Regelmatig hakken en schoffelen is dus de boodschap.

Polet heeft tal van gereedschappen die ons helpen om onkruid op een alternatieve manier te lijf te gaan. Voor grote oppervlaktes kunnen we de "Weedroller" en "Wielschoffel" gebruiken.



BEKIJK DE GEBRUIKSVIDEO

VIA DE QR CODE OF OP
WWW.YOUTUBE.COM/POLETQUALITYPRODUCTS

WEEDROLLER

- **3 FUNCTIES:** schoffelt, belucht en wiedt in één handeling tussen beplanting, rijen van groenten, op niet verharde ondergrond
- **ECOLOGISCH:** door regelmatig te wieden krijgt onkruid geen kans om zich te vermeerderen
- **ERGONOMISCH:** door het brede handvat en de in lengte verstelbare steel kan je mooi rechtop werken
- **DUURZAAM & SLIJTVAST:** hij is gemaakt uit een 2mm dikke, verzinkte en gelakte metaalplaat, en een 2mm (dikte) stalen snijmes



WIELSCHOFFEL

- gemakkelijk onkruid wieden op grote oppervlaktes en verschillende soorten grond
- standaard schoffel 25cm meegeleverd, ook verkrijgbaar met 35cm en 50cm schoffel
- efficiënt
- ergonomisch
- moduleerbaar met verschillende toebehoren
- ecologisch



HAK

- roestvrij staal
- breedtes: 25, 35 en 50 cm
- blad is vervangbaar

VERVANG-BLAD



ECONOMISCH/ECOLOGISCH

Je hebt geen chemische producten meer nodig en verbruikt geen brandstof. Op langere termijn is dit een rendabele investering.









ALTERNATIEVE ONKRUIDBESTRIJDING

WEEDROLLERS







WEEDROLLER 17CM + 2 GEWASBESCHERMERS



Art. Nr.	Verpakking	Code steel
075150	1	-
 5 410685 885819		    







VERVANGBLAD 17CM VOOR WEEDROLLER



Art. Nr.	Verpakking	Code steel
075151	1	-
 5 410685 887875		    







WEEDROLLER 35CM



Art. Nr.	Verpakking	Code steel
075200	1	-
 5 410685 885826		    

VERVANGBLAD 35CM VOOR WEEDROLLER



Art. Nr.	Verpakking	Code steel
075201	1	-
 5 410685 887882		    

WIELSCHOFFELS

WIELSCHOFFEL MET HAK 25CM



Art. Nr.	Verpakking	Code steel
074100	1	-

SCHOFFEL 25CM VOOR WIELSCHOFFEL



Art. Nr.	Verpakking	Code steel
074225	1	-

VERVANGBLAD 25CM VOOR WIELSCHOFFEL



Art. Nr.	Verpakking	Code steel
0742251	1	-

SCHOFFEL 35CM VOOR WIELSCHOFFEL



Art. Nr.	Verpakking	Code steel
074235	1	-

VERVANGBLAD 35CM VOOR WIELSCHOFFEL



Art. Nr.	Verpakking	Code steel
0742351	1	-



SCHOFFEL 50CM VOOR WIELSCHOFFEL



Art. Nr.	Verpakking	Code steel
074250	1	-



VERVANGBLAD 50CM VOOR WIELSCHOFFEL



Art. Nr.	Verpakking	Code steel
0742501	1	-
 5 410685 881897		

NIVELEERHARK VOOR WIELSHOFFEL



Art. Nr.	Verpakking	Code steel
074400	1	-
 5 410685 879221		



AANAARDER VOOR WIELSCHOFFEL



Art. Nr.	Verpakking	Code steel
074300	1	-

WIED-EG VOOR WIELSCHOFFEL



Art. Nr.	Verpakking	Code steel
074500	1	-

TAND VOOR WIED-EG WIELSCHOFFEL



Art. Nr.	Verpakking	Code steel
074501	1	-



6 TANDEN + MOEREN EN BOUTEN VOOR WIED-EG



Art. Nr.	Verpakking	Code steel
074502	1	-

GRASKANTSNIJDER VOOR WIELSCHOFFEL



Art. Nr.	Verpakking	Code steel
074600	1	-

SNEEUWSCHUIVER 80CM VOOR WIELSCHOFFEL



Art. Nr.	Verpakking	Code steel
074700	1	-

CULTIVATOR 3T VOOR WIELSCHOFFEL



Art. Nr.	Verpakking	Code steel
074910	1	-

MES 14CM VOOR WIELSCHOFFEL



Art. Nr.	Verpakking	Code steel
074920	1	-



STEEEL
• essenhout

GEKARTELD VOEGENMES

- roestvrij staal
- onkruidvrij maken van voegen
- altijd scherpe kanten door de gekartelde structuur, zelfs na slijtage
- vervangbaar blad



**BEKIJK DE
GEBRUIKSVIDEO**

VIA DE QR CODE OF OP
[WWW.YOUTUBE.COM/
POLETQUALITYPRODUCTS](http://WWW.YOUTUBE.COM/POLETQUALITYPRODUCTS)



VLEUGELSCHOFFEL

- ideaal om kiemend onkruid te verwijderen
- trekkend als duwend onkruid wieden
- vervangbaar blad
- altijd scherp dankzij gekartelde structuur
- gaat vlot tot in de hoeken dankzij zijn vorm

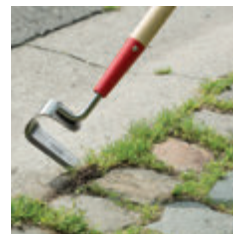
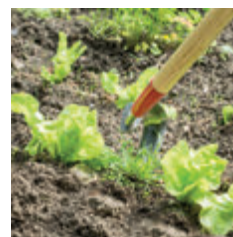
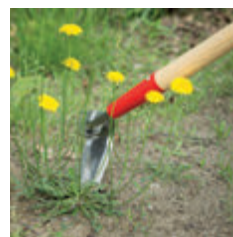

U-SCHOFFELHAK

- roestvrij staal
- multitoel: schoffelen, hakken, wieden, groeven trekken
- zowel trekkend als duwend werken
- dankzij de uitsparing vlot distels en paardenbloemen verwijderen met een hefboom beweging



BEKIJK DE GEBRUIKSVIDEO

VIA DE QR CODE OF OP
WWW.YOUTUBE.COM/POLETQUALITYPRODUCTS



U-SCHOFFELHAK

U-SCHOFFELHAK 60MM M/ST ES 38CM



Art. Nr.	Verpakking	Code steel
1231061	1	-

U-SCHOFFELHAK 100MM M/ST ES 1,5M



Art. Nr.	Verpakking	Code steel
1232101	1	-

U-SCHOFFELHAK LINKS 100MM M/ST ES 1,5M



Art. Nr.	Verpakking	Code steel
1232101L	1	-

U-SCHOFFELHAK 150MM M/ST ES 1,5M



Art. Nr.	Verpakking	Code steel
1232151	1	-

U-SCHOFFELHAK LINKS 150MM M/ST ES 1,5M



Art. Nr.	Verpakking	Code steel
1232151L	1	-

VLEUGELSCHOFFEL

VLEUGELSCHOFFEL 120MM M/ST ES 1,5M



Art. Nr.	Verpakking	Code steel
1242121	1	-

VERVANGBLAD VLEUGELSCHOFFEL 120MM



Art. Nr.	Verpakking	Code steel
124212	1	-

VLEUGELSCHOFFEL 220MM M/ST ES 1,5M



Art. Nr.	Verpakking	Code steel
1242201	1	-



VERVANGBLAD VLEUGELSCHOFFEL 220MM



Art. Nr.	Verpakking	Code steel
124220	1	-

GEKARTELDE VOEGENMES

GEKARTELDE VOEGENMES M/ST ES 1,5M



Art. Nr.	Verpakking	Code steel
035051	1	-

VERVANGBLAD GEKARTELDE VOEGENMES



Art. Nr.	Verpakking	Code steel
035055	1	-

STRAATREINIGINGSMATERIAAL

VOEGENKRABBER



Art. Nr.	Verpakking	Code steel
035045	5	-

VOEGENKRABBER M/ST 1,5M



Art. Nr.	Verpakking	Code steel
0350451	5	143662

VOEGENBORSTEL+KRABBER



Art. Nr.	Verpakking	Code steel
2030MZ	5	-

VOEGENBORSTEL+KRABBER M/ST 1,4M



Art. Nr.	Verpakking	Code steel
2030M	5	143740

VERVANGBORSTEL VOEGENBORSTEL+KLAUW



Art. Nr.	Verpakking	Code steel
2030MZK	5	-

VOEGENBORSTEL+KLAUW M/ST 1,5M



Art. Nr.	Verpakking	Code steel
2030MK	5	143662

VOEGENBORSTEL+KLAUW MET EXTRA VERVANGBLOK



Art. Nr.	Verpakking	Code steel
2031MZK	5	-

VOEGENBORSTEL+KLAUW M/ST 1,5M+EXTRA BLOK



Art. Nr.	Verpakking	Code steel
2031MK	5	143662

KLINKERBORSTEL MESSING M/ST 1,4M



Art. Nr.	Verpakking	Code steel
2035	5	143740



ONKRUIDBRANDERS

- gemakkelijk onkruid bestrijden op een milieuvriendelijke en niet giftige manier
- toepassen op terras, oprit of paden
- te gebruiken in alle weersomstandigheden
- piezo ontsteker



TIP GEBRUIK

- hou de brander enkele seconden op het onkruid gericht
- niet nodig het onkruid zwart te verbranden
- door thermische schok barsten de cellen van het onkruid open en wordt het onkruid vernietigd
- na een aantal behandelingen zal het wortelgestel van het onkruid aangetast zijn en afsterven

KLEINE OPPERVAKTES

- milieuvriendelijk onkruid bestrijden door het te verbranden
- zonder pesticiden biologisch tuinieren
- door thermische schok barsten de cellen van het onkruid open en wordt het onkruid vernietigd
- gascartridge afzonderlijk verkrijgbaar



TROLLEY VOOR GASFLES

- vloerplaat en frame van dik en zwaar staal
- laadvermogen: tot 33kg
- potmover



Art 500401



Art 500402

GROTE OPPERVAKTES

Art 500207 en Art 500210

- werkt met gewone gasflessen
- opgelet: steeds te gebruiken met veiligheidsklep!
- geen ontspanner nodig



ONKRUIDBRANDERS

ONKRUIDBRANDER+GASBUS (500101)



Art. Nr.	Verpakking	Code steel
500100	1	-

GASBUS 600ML



Art. Nr.	Verpakking	Code steel
500101	1	-

DISPLAY ONKRUIDBRANDER (20X500100)



Art. Nr.	Verpakking	Code steel
500100D	1	-

BRANDER 60MM/700MM ONTSTEKER+5M SLANG



Art. Nr.	Verpakking	Code steel
500207	1	-

BRANDER 60MM/1000MM ONTSTEKER+5M SLANG



Art. Nr.	Verpakking	Code steel
500210	1	-

5M SLANG



Art. Nr.	Verpakking	Code steel
500305	1	-

10M SLANG



Art. Nr.	Verpakking	Code steel
500310	1	-

VEILIGHEIDSKLEP GASFLES TYPE SHELL



Art. Nr.	Verpakking	Code steel
500401	1	-

VEILIGHEIDSKLEP GASFLES PRIMAGAS TYPE POL



Art. Nr.	Verpakking	Code steel
500402	1	-

TROLLEY VOOR GASFLES & POTMOVER



Art. Nr.	Verpakking	Code steel
500950	1	-



GARDENING 4 KIDS

GARDENING 4 KIDS



VOLWASSEN TUINIËREN VOOR KINDEREN

Kwaliteitsvol gereedschap op maat van kinderen om mee te helpen in de tuin. Met de groeiende trend rond moestuinieren op scholen en de vierkante meter moestuintjes, komen deze aangepaste gereedschappen zeker ook van pas!





GARDENING 4 KIDS SPADE 85CM



Art. Nr.	Verpakking	Code steel
3020	1	136285
 5 410685 877067		



GARDENING 4 KIDS SCHOP 80CM



Art. Nr.	Verpakking	Code steel
3021	1	131380
 5 410685 877074		





GARDENING 4 KIDS BLADGRITSEL 11T 110CM



Art. Nr.	Verpakking	Code steel
3016	1	143610
 5 410685 877029		





GARDENING 4 KIDS HARK 8T 110CM



Art. Nr.	Verpakking	Code steel
3017	1	143610
		   





GARDENING 4 KIDS CULTIVATOR 3T 110CM



Art. Nr.	Verpakking	Code steel
3018	1	143610
		   



GARDENING 4 KIDS HAK 110CM



Art. Nr.	Verpakking	Code steel
3019	1	143610
		   



GARDENING 4 KIDS BORSTEL 110CM



Art. Nr.	Verpakking	Code steel
3022	1	143710
		 



GARDENING 4 KIDS HEKSENBEZEM MET STEEL



Art. Nr.	Verpakking	Code steel
3024	1	-
		



GARDENING 4 KIDS VERPLANTSCHOPJE



Art. Nr.	Verpakking	Code steel
3025	5	-
		 



GARDENING 4 KIDS HANDCULTIVATOR 3T



Art. Nr.	Verpakking	Code steel
3026	5	-
 5 410685 884515		 



GARDENING 4 KIDS HANDHARKJE 5T



Art. Nr.	Verpakking	Code steel
3027	5	-
 5 410685 884522		 



GARDENING 4 KIDS COMBIHAKJE



Art. Nr.	Verpakking	Code steel
3028	5	-
 5 410685 884539		 

GARDENING 4 KIDS DISPLAY GEVULD (72 ST.)



Art. Nr.	Verpakking	Code steel
3023	1	-
 5 410685 878415		



JUNIOR TOOLS

junior tools



Kleurrijk en kwalitatief tuingereedschap uit metaal en hout, speciaal voor onze jongste tuiniertjes!



JUNIOR 5



JUNIOR 5 KINDERBLADHARK



Art. Nr.	Verpakking	Code steel
3001	20	-
		



JUNIOR 5 KINDERSCHOPJE



Art. Nr.	Verpakking	Code steel
3002	20	-
		



JUNIOR 5 KINDERSPADE



Art. Nr.	Verpakking	Code steel
3003	20	-
		



JUNIOR 5 KINDERHARK



Art. Nr.	Verpakking	Code steel
3004	20	-
		



JUNIOR 5 KINDERPUNTSCHOPJE



Art. Nr.	Verpakking	Code steel
3006	20	-
 5 410685 300053		 

JUNIOR 5 KINDERBEZEM





Art. Nr.	Verpakking	Code steel
3007	10	-
 5 410685 300060		

JUNIOR 8



JUNIOR 8 ZANDSCHOP



Art. Nr.	Verpakking	Code steel
3010	10	-
 5 410685 805145		 



JUNIOR 8 SPADE



Art. Nr.	Verpakking	Code steel
3011	5	-
 5 410685 805152		 





JUNIOR 8 KINDERBEZEM



Art. Nr.	Verpakking	Code steel
3012	10	-
 5 410685 805169		

JUNIOR 8 KINDERHARK



Art. Nr.	Verpakking	Code steel
3013	10	-
 5 410685 805183		  

JUNIOR SETS

JUNIOR 5 SET (3 ST.)



Art. Nr.	Verpakking	Code steel
3009	5	-

JUNIOR 8 SET (4 ST.)

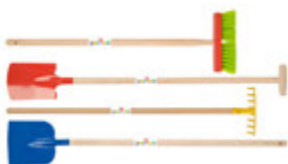

Art. Nr.	Verpakking	Code steel
3014	5	-

JUNIOR TOOLS DISPLAY METAAL (130 ST.)



Art. Nr.	Verpakking	Code steel
250147	1	-

JUNIOR TOOLS DISPLAY KARTON (70 ST.)



Art. Nr.	Verpakking	Code steel
3008	1	-



KINDERKRIIWAGEN-BOLDERKAR

KINDERKRIIWAGEN ROOD



Art. Nr.	Verpakking	Code steel
1087	1	-



- speelplezier voor tuin en strand
- degelijke lekvrije wielen, vrij van schadelijke vluchtige stoffen (Art. Nr. KW555021)
- zachte aangename handgrepen
- een stevig metalen frame en sterke kuip
- laadcapaciteit: 18 L



BOLDERKAR



Art. Nr.	Verpakking	Code steel
750010	1	-

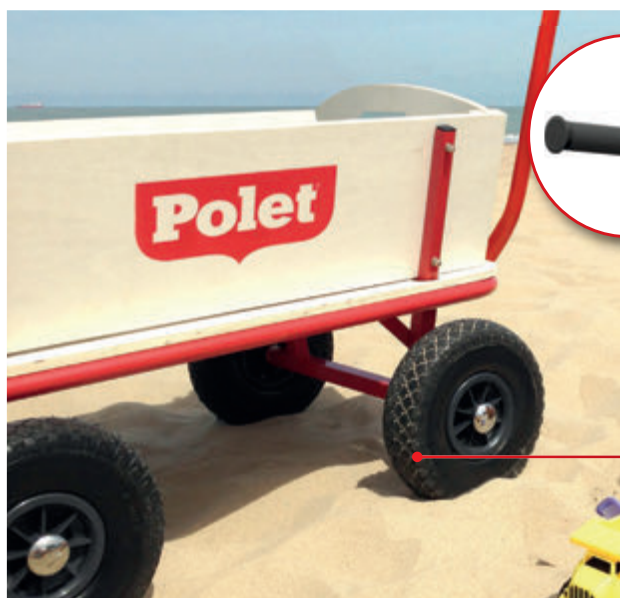

- 2 handgrepen voor gemakkelijke besturing

- sterke disselboom, eenvoudig los te koppelen door de borgpen

- degelijke lekvrije wielen, vrij van schadelijke vluchtige stoffen (Art. Nr. KW555021)
- laadvermogen: maximum 85 kg

HANDGEREEDSCHAP

HANDGEREEDSCHAPPEN MET MEDIUM STEEL

HANDHAK MET MEDIUM STEEL



Art. Nr.	Verpakking	Code steel
030501	1	143605

HANDCULTIVATOR MET MEDIUM STEEL



Art. Nr.	Verpakking	Code steel
030502	1	143605

HANDHARK MET MEDIUM STEEL



Art. Nr.	Verpakking	Code steel
030503	1	143605

HANDSCHOPJE MET MEDIUM STEEL



Art. Nr.	Verpakking	Code steel
030504	1	143605

HANDGEREEDSCHAP

VERPLANTSCHOPJE 85/160MM GEHARD



Art. Nr.	Verpakking	Code steel
030000	5	-

VERPLANTSCHOPJE 50/160MM GEHARD



Art. Nr.	Verpakking	Code steel
030001	5	-

BLOEMBOLLENPLANTER



Art. Nr.	Verpakking	Code steel
030302	5	-

GROENTEHAKJE 80X60MM



Art. Nr.	Verpakking	Code steel
033008	1	151416

GROENTEHAKJE 100X60MM



Art. Nr.	Verpakking	Code steel
033010	5	151416

ASPERGENSTEKER



Art. Nr.	Verpakking	Code steel
035031	5	-

ONKRUIDMES



Art. Nr.	Verpakking	Code steel
035035	5	-

ONKRUIDMES 200MM



Art. Nr.	Verpakking	Code steel
035040	1	-

BLOEMENPLANTSCHOPJE RVS/INOX



Art. Nr.	Verpakking	Code steel
035027	5	-

PLANTSTOK METAAL



Art. Nr.	Verpakking	Code steel
030003	5	-

VERPLANTSCHOPJE







Art. Nr.	Verpakking	Code steel
030303	5	-

HANDCULTIVATOR 3T







BUDGET

Art. Nr.	Verpakking	Code steel
035026	5	-
 5 410685 032923		  

HANDHARKJE 6T







BUDGET

Art. Nr.	Verpakking	Code steel
035028	5	-
 5 410685 032930		  

COMBI-TUINHAKJE







BUDGET

Art. Nr.	Verpakking	Code steel
035029	5	-
 5 410685 032954		  

TUINHAKJE PUNT-SNEDE







BUDGET

Art. Nr.	Verpakking	Code steel
0350212	5	-
 5 410685 881965		  

TUINHAKJE VORK-SNEDE







BUDGET

Art. Nr.	Verpakking	Code steel
0350222	5	-
 5 410685 881972		  

SET HANDGEREEDSCHAP 3-DELIG



BUDGET

Art. Nr.	Verpakking	Code steel
250012	5	-
 5 410685 101926		  

MEELSCHEPPEN

MEELSCHEP ALUMINIUM L185XB60XH40MM 150GR



Art. Nr.	Verpakking	Code steel
056101	5	-

MEELSCHEP ALUMINIUM L275XB98XH63MM 750GR



Art. Nr.	Verpakking	Code steel
056102	5	-

MEELSCHEP ALUMINIUM L370XB135XH88MM 1600GR



Art. Nr.	Verpakking	Code steel
056104	5	-

MEELSCHEP ALUMINIUM L185XB98XH120MM 750GR



Art. Nr.	Verpakking	Code steel
056202	5	-

MEELSCHEP ALUMINIUM L260XB135XH135MM 1600GR



Art. Nr.	Verpakking	Code steel
056201	5	-

MULTISCHEP

MULTISCHEP KUNSTSTOF L320XB120XH105MM

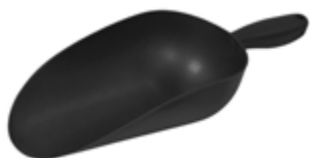

Art. Nr.	Verpakking	Code steel
156104	1	-

HANDSCHOENEN

HANDSCHOENEN

NITRIL COATING

- uiterst beweeglijk en precies
- neutrale PH
- sterke anti-slip
- geen rubberallergie
- vrij van kankerverwekkende stoffen



EN 388

Schuurweerstand	★★★★
Snijweerstand	☆☆☆☆☆
Scheurweerstand	★★★☆☆
Perforatieweerstand	☆☆☆☆

EN 420 SIZES: 8 to 11

Grijptest ★★★★★



HANDSCHOENEN MAAT 8 NITRIL COATING



Art. Nr.	Verpakking	Code steel
038308	6	-

HANDSCHOENEN MAAT 9 NITRIL COATING



Art. Nr.	Verpakking	Code steel
038309	6	-

HANDSCHOENEN MAAT 10 NITRIL COATING



Art. Nr.	Verpakking	Code steel
038310	6	-

HANDSCHOENEN MAAT 11 NITRIL COATING



Art. Nr.	Verpakking	Code steel
038311	6	-

POLET KNIKUSSEN

POLET KNIKUSSEN 440X220X30MM



Art. Nr.	Verpakking	Code steel
1082	1	-

PLANTGEREEDSCHAP

TUINKOORD 25M



Art. Nr.	Verpakking	Code steel
10081	5	-

AARDAPPEL BOLLENPLANTER Ø80MM



Art. Nr.	Verpakking	Code steel
070200	2	-

PREIPLANTER 5T/500MM



Art. Nr.	Verpakking	Code steel
071004	2	-



PLANTSTOK T-ST 300MM



Art. Nr.	Verpakking	Code steel
2014	5	-



PLANTSTOK T-ST 900MM



Art. Nr.	Verpakking	Code steel
071006	5	-
 5 410685 801239		 



RIJENTREKKER 5 REGELBARE TANDEN



Art. Nr.	Verpakking	Code steel
380105	1	-
 5 410685 890165		 

RIJENTREKKER 5 REGELBARE TANDEN M/ST 1,5M



Art. Nr.	Verpakking	Code steel
3801051	1	143662
 5 410685 890172		 

RIJENTREKKER

Manuele rijentrekker voor het trekken van zaai- of plantvoren in de moestuin. Met 5 regelbare tanden en essen steel. Efficiënt 2/3/5 zaairijen naast elkaar trekken, in evenwijdige rechte rijen, in één beweging en met dezelfde tussenstand. Doordat de rijen op een gelijke afstand van elkaar liggen, is er meer ruimte tussen de planten, wat de groei bevordert en het wieden en oogsten vergemakkelijkt. Bij het zaaien op rijen (of lijnen) bespaart men trouwens op zaad. Ideaal voor groenten zoals erwten, uien, boontjes, rode biet, wortelen, ...

- snel en efficiënt
- regelbare tanden: rij-afstand naar keuze
- 2/3/5 zaai/plantrijen in één beweging



TUINROL 52CM Ø33CM



Art. Nr.	Verpakking	Code steel
070707	1	-

TUINROL

- na grondbewerking de overgebleven kluiten verkrumelen
- na rollen, worden oneffenheden zichtbaar om vlot te nivelleren
- drukt de grond egaal aan en geeft regen geen kans tot verzakkingen
- aangedrukte grond bevordert opstijgend grondwater, waardoor pas gekiemd zaad beschermd is tegen uitdroging
- gebruik de rol om korstvorming van de bovenste laag terug open te breken voor het pas gekiemd zaad



OPVULBAAR MET WATER OF ZAND

Water = ideaal voor lichte grond
bv. zandgrond

Zand = ideaal voor zwaardere grond
bv. leem of kleigrond



HARKEN

BLADHARKEN

BLADHARK VAST 22T/410MM



Art. Nr.	Verpakking	Code steel
350000	5	-

BLADHARK VAST 22T/410MM M/ST 1,5M



Art. Nr.	Verpakking	Code steel
3500001	5	143662

BLADHARK VERSTELBAAR 22T/410MM



Art. Nr.	Verpakking	Code steel
350001	5	-

BLADHARK VERSTELBAAR 22T/410MM M/ST 1,5M



Art. Nr.	Verpakking	Code steel
3500011	5	143662

BLADHARK VERSTELBAAR 22T/410MM M/ST FIBER 3001 1,5M



Art. Nr.	Verpakking	Code steel
FH3500011	1	FH143650

BLADHARK VERSTELBAAR 22T PLAT/ROND



Art. Nr.	Verpakking	Code steel
350003	5	-

BLADHARK VERSTELBAAR 22T PLAT/ROND M/ST 1,5M



Art. Nr.	Verpakking	Code steel
3500031	5	143662

BLADHARK VERSTELBAAR 22T PLAT/ROND M/ST FIBER 3001 1,5M



Art. Nr.	Verpakking	Code steel
FH3500031	5	FH143650

BLADHARK 7T ROND VAST 120MM



Art. Nr.	Verpakking	Code steel
350017	1	-

BLADHARK 7T ROND VAST 120MM M/ST 1,5M



Art. Nr.	Verpakking	Code steel
3500171	1	143662

PROF. BLADHARK 20T ROND VAST 430MM



Art. Nr.	Verpakking	Code steel
350011	5	-

PROF. BLADHARK 20T ROND VAST 430MM M/ST 1,5M



Art. Nr.	Verpakking	Code steel
3500111	5	143662

PROF. BLADHARK 22T/520MM VEERBEUGEL

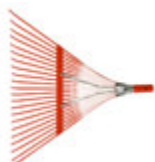

Art. Nr.	Verpakking	Code steel
350012	5	-

PROF. BLADHARK 22T/520MM VEERBEUGEL M/ST 1,5M



Art. Nr.	Verpakking	Code steel
3500121	5	143662

PROF. BLADHARK 22T/520MM VEERBEUGEL M/ST FIBER 3001 1,5M



Art. Nr.	Verpakking	Code steel
FH3500121	5	FH143650

BLADHARK 18T/400MM VERSTELBAAR



BUDGET

Art. Nr.	Verpakking	Code steel
350000E	5	-

BLADHARK 18T/400MM VERSTELBAAR M/ST 1,5M



BUDGET

Art. Nr.	Verpakking	Code steel
3500001E	5	143650

BLADHARK 380MM POLYAMIDE VAST



Art. Nr.	Verpakking	Code steel
350034	1	-

BLADHARK 380MM POLYAMIDE VAST M/ST 1,5M



Art. Nr.	Verpakking	Code steel
3500341	1	143662

BLADHARK 380MM POLYAMIDE VAST M/ST FIBER3001 1,5M



Art. Nr.	Verpakking	Code steel
FH3500341	1	FH143650

PROF. BLADHARK 450MM POLYAMIDE VAST



Art. Nr.	Verpakking	Code steel
350024	1	-

PROF. BLADHARK 450MM POLYAMIDE VAST M/ST 1,5M



Art. Nr.	Verpakking	Code steel
3500241	1	143662

PROF. BLADHARK 450MM POLYAMIDE VAST M/ST FIBER 3001 1,5M



Art. Nr.	Verpakking	Code steel
FH3500241	1	FH143650

PROF. BLADHARK 600MM POLYAMIDE VAST



Art. Nr.	Verpakking	Code steel
350014	5	-

PROF. BLADHARK 600MM POLYAMIDE VAST M/ST 1,5M



Art. Nr.	Verpakking	Code steel
3500141	5	143662

PROF. BLADHARK 600MM POLYAMIDE VAST M/ST FIBER 3001 1,5M



Art. Nr.	Verpakking	Code steel
FH3500141	5	FH143650

PROF. BLADHARK 30T/800MM POLYPROPYLEEN VAST M/ST 1,5M



Art. Nr.	Verpakking	Code steel
3500161	5	143662

GROTE BLADHARK

- ruime werkbreedte met meerdere verstevigingen = 80cm
- 30 tanden
- harken op stenige, begroeide bodem mogelijk
- polypropyleen = soepel en sterk



BEKIJK DE GEBRUIKSVIDEO
VIA DE QR CODE
OF OP [WWW.YOUTUBE.COM/
POLETQUALITYPRODUCTS](http://WWW.YOUTUBE.COM/POLETQUALITYPRODUCTS)

BLADHARK 21T/380MM POLYPROPYLEEN VAST



BUDGET

Art. Nr.	Verpakking	Code steel
350002	5	-

BLADHARK 21T/380MM POLYPROPYLEEN VAST M/ST 1,4M



BUDGET

Art. Nr.	Verpakking	Code steel
3500021	5	143740

BLADHARK 450MM POLYPROPYLEEN



BUDGET

Art. Nr.	Verpakking	Code steel
350004	10	-

BLADHARK 450MM POLYPROPYLEEN M/ST 1,5M





BUDGET

Art. Nr.	Verpakking	Code steel
3500041	5	143650

BLADHARK 450MM POLYPROPYLEEN M/ST FIBER 3001 1,5M





Art. Nr.	Verpakking	Code steel
FH3500041	5	FH143650
		

MULTIHARK



POLY-HARK 18T ERGO-LIGHT



Art. Nr.	Verpakking	Code steel
350021	1	-
		



POLY-HARK 18T ERGO-LIGHT/ALU D-ST 1,2M



Art. Nr.	Verpakking	Code steel
350020	5	ST9350015
		

POLY- HARK / DISPLAY 10 STUKS





Art. Nr.	Verpakking	Code steel
350020D	1	-
		

TUINHARKEN



TUINHARK 12T/350MM



Art. Nr.	Verpakking	Code steel
030212	5	-
		



TUINHARK 12T/350MM M/ST 1,5M



Art. Nr.	Verpakking	Code steel
0302121	5	143662
		



TUINHARK 12T/310MM M/ST FIBER 3001 1,5M



Art. Nr.	Verpakking	Code steel
FH0302121	5	FH143650
 5 410685 855027		



TUINHARK 14T/410MM



Art. Nr.	Verpakking	Code steel
030214	5	-
 5 410685 031186		



TUINHARK 14T/410MM M/ST 1,5M



Art. Nr.	Verpakking	Code steel
0302141	5	143662
 5 410685 031223		



TUINHARK 16T/470MM



Art. Nr.	Verpakking	Code steel
030216	5	-
 5 410685 031193		



TUINHARK 16T/470MM M/ST 1,5M



Art. Nr.	Verpakking	Code steel
0302161	5	143662
 5 410685 031230		

BLOEMEN ROZENHARK 10T/243X70X3MM



Art. Nr.	Verpakking	Code steel
030310	1	-
 5 410685 875841		

BLOEMEN ROZENHARK 10T/243X70X3MM M/ST 1,5M



Art. Nr.	Verpakking	Code steel
0303101	1	143662

TUINHARK 14T VERSTEVIGD M/ST 1,65M



Art. Nr.	Verpakking	Code steel
0301141	5	141456K

HARK 8T/200MM



BUDGET

Art. Nr.	Verpakking	Code steel
030308E	5	-

HARK 8T/200MM M/ST 1,5M



BUDGET

Art. Nr.	Verpakking	Code steel
0303081E	5	143650

HARK 10T/250MM



BUDGET

Art. Nr.	Verpakking	Code steel
030310E	5	-

HARK 10T/250MM M/ST 1,5M







BUDGET

Art. Nr.	Verpakking	Code steel
0303101E	5	143650

HARK 12T/310MM







BUDGET

Art. Nr.	Verpakking	Code steel
030312E	5	-
 5 410685 031254		  

HARK 12T/310MM M/ST 1,5M







BUDGET

Art. Nr.	Verpakking	Code steel
0303121E	5	143650
 5 410685 031292		   

HARK 14T/340MM







BUDGET

Art. Nr.	Verpakking	Code steel
030314E	5	-
 5 410685 031261		  

HARK 14T/340MM M/ST 1,5M







BUDGET

Art. Nr.	Verpakking	Code steel
0303141E	5	143650
 5 410685 031308		   

HARK 16T/370MM







BUDGET

Art. Nr.	Verpakking	Code steel
030316E	5	-
 5 410685 031278		  

HARK 16T/370MM M/ST 1,5M



BUDGET

Art. Nr.	Verpakking	Code steel
0303161E	5	143650
 5 410685 031315		   

BEUGELHARK 14T/340MM



BUDGET

Art. Nr.	Verpakking	Code steel
030318E	5	-

BEUGELHARK 14T/340MM M/ST 1,5M



BUDGET

Art. Nr.	Verpakking	Code steel
0303181E	5	143650

LANDHARKEN

LANDHARK METAAL 10T/500MM



Art. Nr.	Verpakking	Code steel
070701	2	-

LANDHARK METAAL 10T/500MM M/ST 1,5M



Art. Nr.	Verpakking	Code steel
0707011	2	143663

LANDHARK ALU VERSTELBAAR 18T/600MM



Art. Nr.	Verpakking	Code steel
070703	2	-





LANDHARK ALU VERSTELBAAR 18T/600MM M/ST 1,5M



Art. Nr.	Verpakking	Code steel
0707031	2	143662





LANDHARK ALU VERSTELBAAR 18T/600MM M/ST FIBER 1,5M



Art. Nr.	Verpakking	Code steel
FH0707031	1	FH143650
 5 410685 874059		   





LANDHARK ALU VERSTELBAAR 17T/760MM



Art. Nr.	Verpakking	Code steel
070704	2	-
 5 410685 032404		  





LANDHARK ALU VERSTELBAAR 17T/760MM M/ST 1,5M



Art. Nr.	Verpakking	Code steel
0707041	2	143662
 5 410685 032411		   





LANDHARK ALU 16T/620MM



Art. Nr.	Verpakking	Code steel
070705	3	-
 5 410685 036631		  

LANDHARK ALU 16T/620MM M/ST 1,5M





Art. Nr.	Verpakking	Code steel
0707051	3	143662
 5 410685 036655		   

GAZONHARKEN-VERTICUTEERHARKEN

VERTICUTEERHARK 21T/400MM



Art. Nr.	Verpakking	Code steel
030230	3	-
 5 410685 031377		 

VERTICUTEERHARK 21T/400MM M/ST 1,5M



Art. Nr.	Verpakking	Code steel
0302301	3	143662

GAZONHARK 580MM



Art. Nr.	Verpakking	Code steel
030300	3	-

GAZONHARK 580MM M/ST 1,5M



Art. Nr.	Verpakking	Code steel
0303001	3	143662

GAZONHARK 710MM



Art. Nr.	Verpakking	Code steel
030301	3	-

GAZONHARK 710MM M/ST 1,5M



Art. Nr.	Verpakking	Code steel
0303011	3	143662

GAZONHARKEN

- unieke kluitenbreker
- extra geharde tanden
- buitenste tanden dubbel zo dik, plooiën niet!



DUBBELE GAZONHARK 28T / 56CM M/ST



Art. Nr.	Verpakking	Code steel
0303201	3	-

DUBBELE GAZONHARK

- dubbele hark met grijpsysteem
- efficiënt
- ergonomisch & licht



BEKIJK DE GEBRUIKSVIDEO
VIA DE QR CODE
OF OP [WWW.YOUTUBE.COM/
POLETQUALITYPRODUCTS](http://WWW.YOUTUBE.COM/POLETQUALITYPRODUCTS)

GAZONHARKEN-POLYAMIDE

GAZONHARK 32T/640MM POLYAMIDE



Art. Nr.	Verpakking	Code steel
030300K	3	-

GAZONHARK 32T/640MM POLYAMIDE M/ST 1,5M



Art. Nr.	Verpakking	Code steel
0303001K	3	143662

GAZONHARK 16T/600MM POLYAMIDE



Art. Nr.	Verpakking	Code steel
030303K	3	-

GAZONHARK 16T/600MM POLYAMIDE M/ST 1,5M



Art. Nr.	Verpakking	Code steel
0303031K	3	143662

HOOIRIJVEN-POLYAMIDE

HOOIRIJF 16T/500MM POLYAMIDE



Art. Nr.	Verpakking	Code steel
151206K	2	-

HOOIRIJF 16T/500MM POLYAMIDE M/ST 1,5M



Art. Nr.	Verpakking	Code steel
1512061K	2	143662

GRASKANTSTEKERS

GRASKANTSTEKER T-ST 90CM



Art. Nr.	Verpakking	Code steel
045001	5	138282

GRASKANTSTEKER T-ST METAAL



Art. Nr.	Verpakking	Code steel
045006	5	-

GRASKANTSTEKER ERGO METAAL



Art. Nr.	Verpakking	Code steel
045008	1	-

ROLGRASKANTSTEKER METAAL-INOX SCHIJF



Art. Nr.	Verpakking	Code steel
045100	1	-

GRASKANTSTEKER T-ST 90CM



Art. Nr.	Verpakking	Code steel
045003	5	138283

MAAIGEREEDSCHAP

ZEIS



Afmeting	Art. Nr.	Verpakking	Code steel	
400MM	320040	3	-	
500MM	320050	3	-	
600MM	320060	3	-	
650MM	320065	3	-	

ZEISSTEEL MET 2 HANDGREPEN



Art. Nr.	Verpakking	Code steel
320005	5	-

T-HANDVAT VOOR ZEISENSTEEL



Art. Nr.	Verpakking	Code steel
320004	5	-

HANDGREEP HOUT Ø36MM VOOR ZEISENSTEEL



Art. Nr.	Verpakking	Code steel
320001	5	-

ZEISENRING+SLEUTEL



Art. Nr.	Verpakking	Code steel
320003	5	-

SIKKEL HALVE MAAN GESMEED



Art. Nr.	Verpakking	Code steel
321000	5	-

ZEISENSIKKEL 270MM GESMEED



Art. Nr.	Verpakking	Code steel
322000	5	-

SIKKEL 50CM GESMEED MET SNEDE BESCHERMING



Art. Nr.	Verpakking	Code steel
321001	1	-

WETSTEEN CARBORUNDUM



Art. Nr.	Verpakking	Code steel
323000	5	-

ZEISENSTRIJKER



Art. Nr.	Verpakking	Code steel
323100	5	-

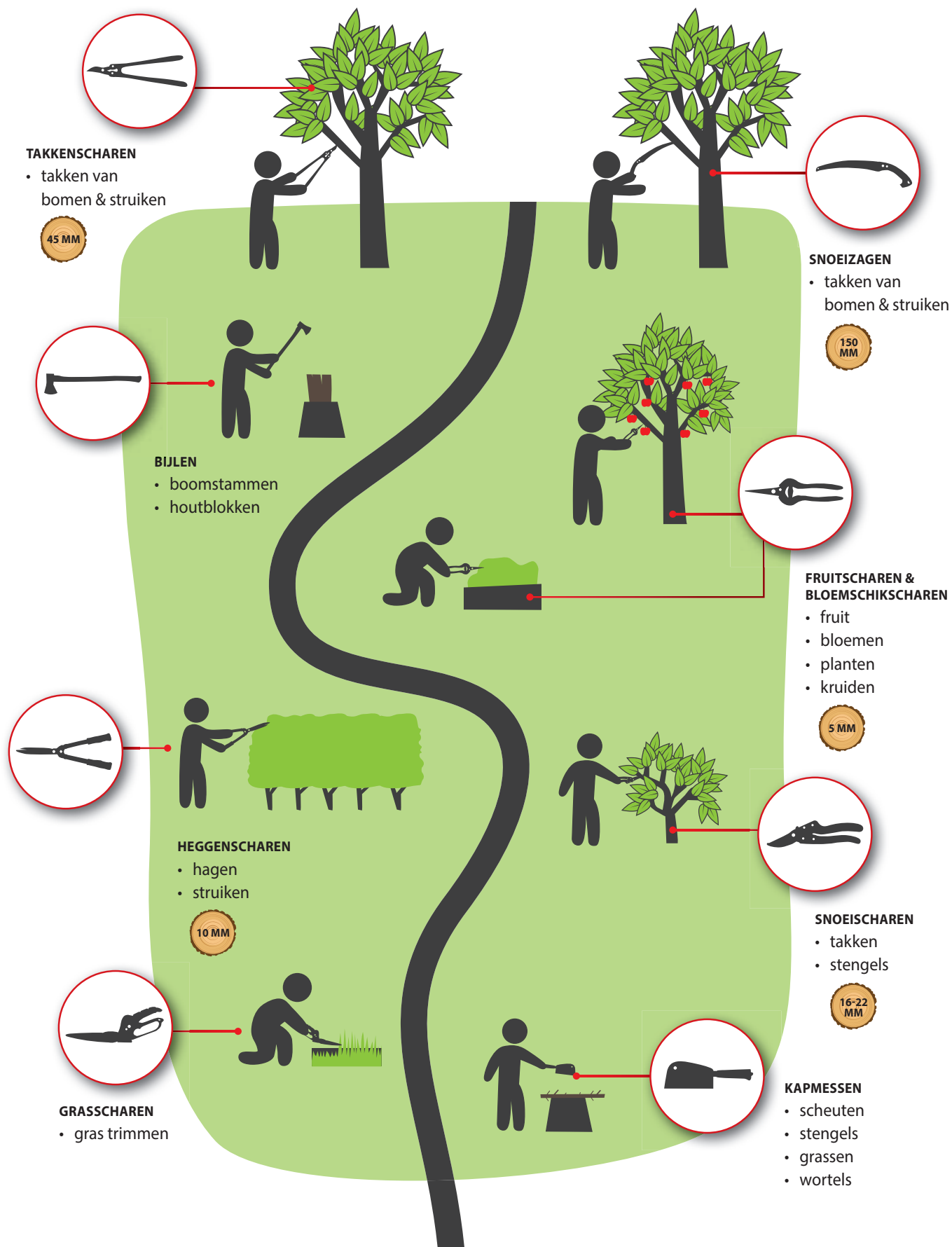

OVERZICHT SNOEIGEREEDSCHAPPEN



GRAS-EN BUXUSSCHAREN



GRASSCHAAR 350MM DRAAIBAAR



Art. Nr.	Verpakking	Code steel
PP14003	5	-
 5 410685 853269		 

BUXUSSCHAAR 300MM







Art. Nr.	Verpakking	Code steel
PP14002	3	-
 5 410685 853382		 

SNOEISCHAREN



SNOEISCHAAR POLET 2-210MM



Art. Nr.	Verpakking	Code steel
PP11002	5	-
 5 410685 853191		  



SNOEISCHAAR POLET 5-225MM



Art. Nr.	Verpakking	Code steel
PP11005	5	-
 5 410685 853207		 





SNOEISCHAAR POLET 7-210MM



Art. Nr.	Verpakking	Code steel
PP11007	5	-
 5 410685 853214		 





SNOEISCHAAR POLET 8-210MM



Art. Nr.	Verpakking	Code steel
PP11008	5	-
 5 410685 853221		  





SNOEISCHAAR POLET PRO-210MM



Art. Nr.	Verpakking	Code steel
PP11014	1	-
 5 410685 875070		  





SNOEISCHAAR 212MM ALU HANDVATEN



Art. Nr.	Verpakking	Code steel
PP11016	1	-
 5 410685 879382		   

SNOEISCHAAR EASY LOCK 200MM



Art. Nr.	Verpakking	Code steel
PP11018	1	-
 5 410685 891001		  



SNOEISCHAAR EASY LOCK 200MM MET AAMBEELD



Art. Nr.	Verpakking	Code steel
PP11019	1	-

SNOEISCHAAR 210MM MET AAMBEELD



Art. Nr.	Verpakking	Code steel
PP20006	1	-

SNOEISCHAAR 160MM



Art. Nr.	Verpakking	Code steel
PP11017	5	-

SNOEISCHAAR 215MM



Art. Nr.	Verpakking	Code steel
PP11010	5	-

TOONBANKDISPLAY SNOEISCHAREN 160MM & 215MM - 20ST



Art. Nr.	Verpakking	Code steel
PP11010D	1	-

RESERVE VEER - PER PAAR





Art. Nr.	Verpakking	Code steel
PP11021	1	-

FRUITSCHAREN



FRUITSCHAAR-BLOEMSCHIKSCHAAR 185MM



Art. Nr.	Verpakking	Code steel
PP11009	5	-
 5 410685 853184		

FRUITSCHAAR-BLOEMSCHIKSCHAAR 200MM





Art. Nr.	Verpakking	Code steel
PP11015	1	-
 5 410685 879375		

HEGGESCHAREN



GESMEDE HEGGENSCHAAR BAMBOE GEGOLFDE SNEDE 200/560



Art. Nr.	Verpakking	Code steel
PP12003BB	1	-
 5 410685 873724		



HEGGENSCHAAR RECHT 200/650MM ALU GREEP



Art. Nr.	Verpakking	Code steel
PP12001	3	-
 5 410685 853276		



HEGGENSCHAAR RECHT 230/570MM



Art. Nr.	Verpakking	Code steel
PP12002	3	-
 5 410685 853320		

HEGGENSCHAAR RECHT 200/540MM



Art. Nr.	Verpakking	Code steel
PP12004	3	-
 5 410685 853528		

HEGGENSCHAAR RECHT 610MM ALU TUBE



Art. Nr.	Verpakking	Code steel
PP12005	1	-

HEGGENSCHAAR GEGOLFDE SNEDE 560MM GESMEED ALU



Art. Nr.	Verpakking	Code steel
PP12006	1	-

TAKKENSCHAREN

TAKKENSCHAAR BAMBOE PRO 710MM CAPACITEIT 42MM



Art. Nr.	Verpakking	Code steel
PP13003BB	1	-

TAKKENSCHAAR PRO 710MM CAPACITEIT 42MM



Art. Nr.	Verpakking	Code steel
PP13003	3	-

TAKKENSCHAAR 720MM ALU TUBE



Art. Nr.	Verpakking	Code steel
PP13004	1	-

TAKKENSCHAAR 540MM GESMEED ALU





Art. Nr.	Verpakking	Code steel
PP13005	1	-

SNOEIZAGEN



SNOEIZAAG 180MM-PLOOIBAAR



Art. Nr.	Verpakking	Code steel
PP15001	3	-
		 



SNOEIZAAG 180MM-PLOOIBAAR RUBBER GRIP



Art. Nr.	Verpakking	Code steel
PP15002	3	-
		 



SNOEIZAAG 300MM-RECHT BLAD



Art. Nr.	Verpakking	Code steel
PP15003	3	-
		 

SNOEIZAAG 340MM-GEBOGEN BLAD



Art. Nr.	Verpakking	Code steel
PP15004	5	-
		 

BEUGELZAGEN

BEUGELZAAG DROOG EN NAT HOUT 530MM



Art. Nr.	Verpakking	Code steel
PP15011	3	-

ZAAGBLAD DROOG EN NAT HOUT 530MM



Art. Nr.	Verpakking	Code steel
PP15011BL	1	-

BEUGELZAAG DROOG EN NAT HOUT 760MM

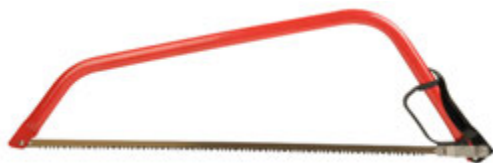

Art. Nr.	Verpakking	Code steel
PP15012	3	-

ZAAGBLAD DROOG EN NAT HOUT 760MM



Art. Nr.	Verpakking	Code steel
PP15012BL	1	-



TUIN- EN HOBBYMESSEN

TUINMESSEN

ENTMES STAINLESS HEFT ES



Art. Nr.	Verpakking	Code steel
PP21002	12	-

HOBBYMESSEN

SNOEIMES STAINLESS HEFT ES



Art. Nr.	Verpakking	Code steel
PP21001	12	-

ENTMES STAINLESS HEFT ES



Art. Nr.	Verpakking	Code steel
PP21003	12	-

ACCESSOIRES

ETUI VR. SNOEISCHAAR



Art. Nr.	Verpakking	Code steel
PP11020	5	-

MULTISLIJPER



Art. Nr.	Verpakking	Code steel
PP16001	5	-

MESSENSLIJPER MET ZUIGNAP



Art. Nr.	Verpakking	Code steel
PP16003	5	-

HOUT- EN BOSGEREEDSCHAP

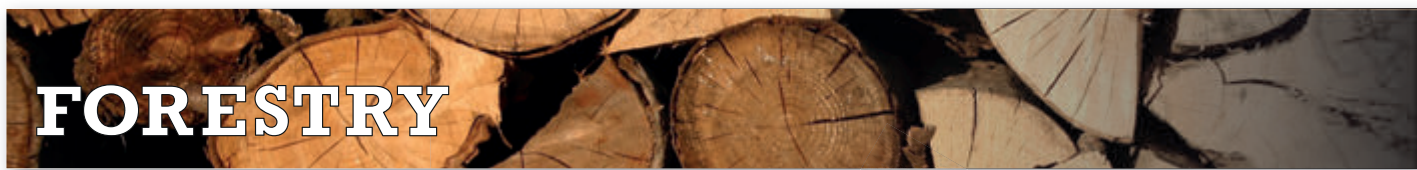

STEEL

- uniek gebogen steel
- ergonomisch in gebruik
- heel licht maar ook zeer sterk
- liggen perfect in de hand en zijn dus veiliger
- anti-slip uitvoering is vervaardigd uit nieuwe en innovatieve kunststof
- behoudt zijn eigenschappen bij zowel hoge als lage temperaturen
- aan het uiteinde van het handvat is een opening voor het bevestigen van een snoer en karabijnhaak



BLAD

- vervaardigd van hoogwaardig veredelingsstaal
- heel precies uitgesneden
- in vorm gebracht door een laser

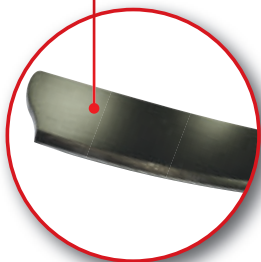

BESCHERMHOES

- geleverd met een plastic beschermhoes voor optimale veiligheid



INTERESSANT WEETJE

De vormgeving van de steel kwam tot stand door een intensieve samenwerking met gebruikers en trainingscentra voor bosbouw. Ze zijn dus speciaal op maat van de professionele gebruiker gemaakt!



HANDSAPPIE FORESTRY 60CM



HANDSAPPIE MET SLAGKOP FORESTRY 60CM



HANDSAPPIE HAKMES FORESTRY 60CM



HAKBIJL FORESTRY 60CM



UITDUNNINGS BIJL FORESTRY 60CM









VEL-HEFBOOM FORESTRY 60CM

HOUT- EN BOSGEREEDSCHAP

FORESTRY TOOLS







HANDSAPPIE FORESTRY 60CM



Art. Nr.	Verpakking	Code steel
650100	1	-
 5 410685 890011		    







HANDSAPPIE MET SLAGKOP FORESTRY 60CM



Art. Nr.	Verpakking	Code steel
650101	1	-
 5 410685 890028		    







HANDSAPPIE MET HAKMES FORESTRY 60CM



Art. Nr.	Verpakking	Code steel
650102	1	-
 5 410685 890035		    







HAKBIJL FORESTRY 60CM



Art. Nr.	Verpakking	Code steel
650103	1	-
 5 410685 890042		    







UITDUNNINGSBIJL FORESTRY 60CM



Art. Nr.	Verpakking	Code steel
650201	1	-
 5 410685 890073		    

VEL-HEFBOOM FORESTRY 60CM



Art. Nr.	Verpakking	Code steel
650301	1	-
 5 410685 890059		    

HANDBIJLTJES

HANDBIJLTJE 600GR M/ST 36CM



Hickory Wood

Art. Nr.	Verpakking	Code steel
060304	5	141310

HANDBIJLTJE 800GR M/ST 38CM



Hickory Wood

Art. Nr.	Verpakking	Code steel
060301	5	141310

HANDBIJLTJE 800GR M/ST FIBER 5001 38CM



Art. Nr.	Verpakking	Code steel
FC060301	5	-

HANDBIJLTJE 1000GR M/ST 40CM



Hickory Wood

Art. Nr.	Verpakking	Code steel
060305	5	141310



BIJLEN

BIJL 1250GR M/ST 70CM



Art. Nr.	Verpakking	Code steel
060302	5	141394

BIJL 1600GR M/ST 80CM



Art. Nr.	Verpakking	Code steel
060300	2	141390

BIJL 1600GR M/ST FIBER 5001 80CM



Art. Nr.	Verpakking	Code steel
FC060300	2	-

BIJL 1800GR M/ST 90CM



Art. Nr.	Verpakking	Code steel
060303	2	141392

BIJL 1800GR M/ST FIBER 5001 90CM



Art. Nr.	Verpakking	Code steel
FC060303	2	-

KLIEFHAMERS





FSC 100% KLIEFHAMER 3KG M/ST 90CM



Art. Nr.	Verpakking	Code steel
060431	1	141990/141995





KLIEFHAMER 3KG FIBER 5001 90CM



Art. Nr.	Verpakking	Code steel
FC186430	1	-
		  

KLIEFHAMER 3KG FIBER 9001 90CM







Art. Nr.	Verpakking	Code steel
186430	1	-
		  

WIGGEN





WIG



Gewicht	Art. Nr.	Verpakking	Code steel	
1500 GR	061015	2	-	 5410685875100
2000 GR	061020	2	-	 5410685040249
2500 GR	061025	2	-	 5410685040256
3000 GR	061030	1	-	 5410685875117





VELWIG UIT POLYAMIDE/KWF FK 190



Art. Nr.	Verpakking	Code steel
650020	1	-
		  





VELWIG UIT POLYAMIDE/KWS FK 250-32



Art. Nr.	Verpakking	Code steel
650021	1	-
		  

VELWIG UIT POLYAMIDE NK 190





Art. Nr.	Verpakking	Code steel
650022	1	-
 5 410685 890264		  

KAPMESSEN



KAPMES 20CM



Art. Nr.	Verpakking	Code steel
061220	5	141320
 5 410685 040140		 



KAPMES MODEL PARIJS 23CM-LEDEREN HECHT



Art. Nr.	Verpakking	Code steel
061230	5	-
 5 410685 875773		 

KAPMES 30CM-LEDEREN HECHT



Art. Nr.	Verpakking	Code steel
061240	5	-
 5 410685 875780		 



2-ZIJDIG KAPMES 23CM HOUTEN HANDVAT



Art. Nr.	Verpakking	Code steel
061250	5	-

2-ZIJDIG BRAMEN KAPMES 45CM HOUTEN HANDVAT



Art. Nr.	Verpakking	Code steel
061260	5	-

SIKKEL 24CM ZONDER STEEL



Art. Nr.	Verpakking	Code steel
321012	1	141453

SIKKEL 24CM M/ST 135CM



Art. Nr.	Verpakking	Code steel
321002	1	141453

SIKKEL MET 2 ZIJDEN ZONDER STEEL



Art. Nr.	Verpakking	Code steel
321013	1	141453

SIKKEL MET 2 ZIJDEN M/ST 135CM



Art. Nr.	Verpakking	Code steel
321003	1	141453

ZAAGBOKKEN

ZAAGBOK 25



Art. Nr.	Verpakking	Code steel
061600	1	-

BULKZAAGBOK 120X110X60CM



Art. Nr.	Verpakking	Code steel
061620	1	-

ZAAGBOKKEN

- ergonomisch
- opvouwbaar
- veilig

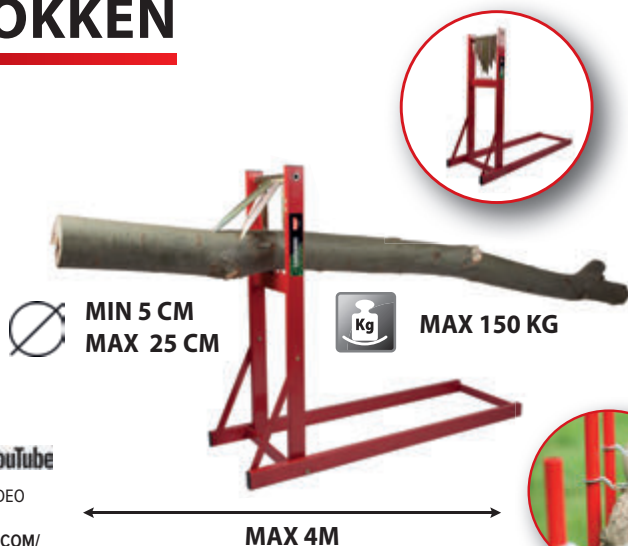

BEKIJK DE GEBRUIKSVIDEO
VIA DE QR CODE
OF OP [WWW.YOUTUBE.COM/
POLETQUALITYPRODUCTS](http://WWW.YOUTUBE.COM/POLETQUALITYPRODUCTS)

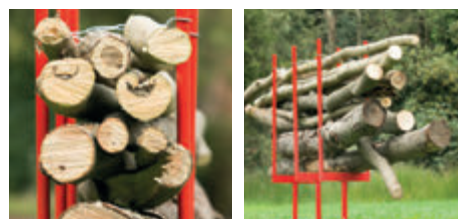

- meerdere stammen tegelijk zagen mogelijk met de bulkzaagbok
- drie kettingen zorgen ervoor dat de stammen op hun plaats worden gehouden tijdens het zagen

PALENBOREN

GESMEDE SPIRAALBOREN

SPIRAALBOOR GESMEED



Afmeting	Art. Nr.	Verpakking	Code steel	
60MM	021126	2	-	 5410685031568
80MM	021128	2	-	 5410685031575
100MM	022210	2	-	 5410685031582
120MM	022212	2	-	 5410685031599
150MM	022215	2	-	 5410685031605

SPIRAALBOREN

SPIRAALBOOR 75MM



Art. Nr.	Verpakking	Code steel
021128E	2	-
 5 410685 036617		

SPIRAALBOOR 100MM



Art. Nr.	Verpakking	Code steel
022210E	2	-
 5 410685 031629		

SCHROEFBOREN

SCHROEFBOOR



Afmeting	Art. Nr.	Verpakking	Code steel	
70MM	022207A	2	-	 5410685052136
90MM	022210A	2	-	 5410685052570
110MM	022211A	2	-	 5410685809327
130MM	022213A	2	-	 5410685809334
150MM	022215A	2	-	 5410685052587

DUBBELE SCHELPSPADE

DUBBELE SCHELPSPADE M/ST 120CM



Art. Nr.	Verpakking	Code steel
100004	1	-

TUINHAMERS-SLEGGERS

TUINHAMER KUNSTSTOF 4,5KG M/ST 1M



Art. Nr.	Verpakking	Code steel
151002	1	151006

TUINHAMER KUNSTSTOF 4,75KG FIBER 9001 90CM



Art. Nr.	Verpakking	Code steel
151001	1	14036CS

TUINHAMER HOUT 4,8KG M/ST 1M



Art. Nr.	Verpakking	Code steel
151009	1	151005

LANDBOUWHAMER METAAL 4,5KG M/ST 1M



Art. Nr.	Verpakking	Code steel
151003	1	151502

VOORHAMER 4KG VIERKANT 90CM



Art. Nr.	Verpakking	Code steel
081414E	1	-

PALENDAMMERS

PALENDAMMER 12KG-Ø10



Art. Nr.	Verpakking	Code steel
151011	1	-

PALENDAMMER 14KG-Ø12



Art. Nr.	Verpakking	Code steel
151008	1	-

PALENDAMMER 14KG-Ø15,8



Art. Nr.	Verpakking	Code steel
151004	1	-

POLET BAGS

POLET BAG



Afmeting	Art. Nr.	Verpakking	Code steel	
70L Ø45CM H:45CM	1035	6	-	 5410685805107
140L Ø54CM H:62CM	1036	6	-	 5410685805114
210L Ø62CM H:67CM	1037	6	-	 5410685805138
270L Ø66CM H:76CM	1039	6	-	 5410685868102

POLET BAG POP UP



Afmeting	Art. Nr.	Verpakking	Code steel	
95L Ø45CM H:60CM	1071	6	-	 5410685811160
175L Ø56CM H:71CM	1072	6	-	 5410685811177

POLET BAG EXTRA STRONG



Afmeting	Art. Nr.	Verpakking	Code steel	
95L Ø46CM H:58CM	1076	6	-	 5410685857038
175L Ø56CM H:70CM	1077	6	-	 5410685857052

POLET BAG 120L - SQUARE 45X76CM



Art. Nr.	Verpakking	Code steel
1080	6	-
 5 410685 875339		

POLET BAG 270L - SQUARE 67X76CM



Art. Nr.	Verpakking	Code steel
1081	6	-
 5 410685 875346		

TUBTRUGS

TUBTRUGS FLEXIBLE

TUBTRUGS FLEXIBLE

- tuinieren
- huishouden
- shopping
- hobby
- bouw
- landbouw
- veeteelt
- manege







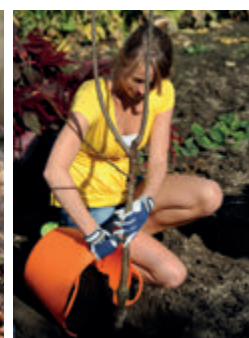

... 1001 TOEPASSINGEN!

Tubtrugs® is een flexibele multifunctionele kuip/emmer. Handig, veelzijdig, supersterk en voedselveilig.





TUBTRUG S 14L H23-Ø33



Kleur	Art. Nr.	Verpakking	Code steel	
 BLAUW	TTSP14BL	10	-	 729848000460
 GROEN	TTSP14G	10	-	 729848000453
 ORANJE	TTSP14O	10	-	 729848000620
 PAARS	TTSP14P	10	-	 729848000484
 ROZE	TTSP14PK	10	-	 729848000477
 ROOD	TTSP14R	10	-	 729848000446

TUBTRUG 15L H16-Ø39



Kleur	Art. Nr.	Verpakking	Code steel	
 GROEN	TTSP15G	5	-	 729848001542



TUBTRUG M 26L H30-Ø39



Kleur	Art. Nr.	Verpakking	Code steel	
BLAUW	TTSP26BL	10	-	729848000248
GROEN	TTSP26G	10	-	729848000071
ORANJE	TTSP26O	10	-	729848000231
PAARS	TTSP26P	10	-	729848000224
ROZE	TTSP26PK	10	-	729848000286
PISTACHE	TTSP26PST	10	-	729848000590
ROOD	TTSP26R	10	-	729848000255
HEMELS-BLAUW	TTSP26SKBL	10	-	729848000576

TUBTRUG 35L H16-Ø57



Kleur	Art. Nr.	Verpakking	Code steel	
GROEN	TTSP35G	5	-	729848000828





TUBTRUG L 42L H33-Ø45



Kleur	Art. Nr.	Verpakking	Code steel	
 BLAUW	TTSP42BL	10	-	 729848000101
 GROEN	TTSP42G	10	-	 729848000088
 ORANJE	TTSP42O	10	-	 729848000095
 PAARS	TTSP42P	10	-	 729848000194
 ROZE	TTSP42PK	10	-	 729848000293
 PISTACHE	TTSP42PST	10	-	 729848000606
 ROOD	TTSP42R	10	-	 729848000118
 HEMELS-BLAUW	TTSP42SKBL	10	-	 729848000583

TUBTRUG XL 75L H37-Ø57



Kleur	Art. Nr.	Verpakking	Code steel	
 GROEN	TTTC75G	5	-	 729848000200



TUBTRUGS RECYCLED

TUBTRUG RECYCLED BLACK



Afmeting	Art. Nr.	Verpakking	Code steel	
14L H23-Ø33	TTSP14REBK	10	-	 729848001436
26L H30-Ø39	TTSP26REBK	10	-	 729848001443
42L H33-Ø45	TTSP42REBK	10	-	 729848001450
75L H37-Ø57	TTTC75REBK	5	-	 729848001474

EMMERS

FIEL

- echte rubber
- robuust en duurzaam
- extreem bestendig tegen breuk ook bij vrieskou!
- stapelbaar
- gemaakt met gerecycleerde materialen 100% recycleerbaar
- bestand tegen hitte tot 100 °C



FIEL KALVEREMMER 22L H31-Ø37CM



Art. Nr.	Verpakking	Code steel
FI3901	5	-

FIEL PAARDENEMMER 17L H30-Ø34CM





Art. Nr.	Verpakking	Code steel
FI3905	5	-

FIEL LANDBOUWEMMER 14L H31-Ø34CM





Art. Nr.	Verpakking	Code steel
FI3908	10	-



FIEL EMMER 12L NR 52 H29-Ø33CM

Art. Nr.	Verpakking	Code steel
FI3910	10	-
 8 424775 207457		



FIEL PLASTIEK EMMER 12L H30-Ø33CM

Art. Nr.	Verpakking	Code steel
FI3916	10	-
 8 424775 401404		



FIEL EMMER 12L NR 51 H30-Ø33CM

Art. Nr.	Verpakking	Code steel
FI3917	10	-
 8 424775 207426		



FIEL EMMER 10L H30-Ø34CM

Art. Nr.	Verpakking	Code steel
FI3909	10	-
 8 424775 207327		

MANDEN**FIEL MAND 25L H29-Ø36CM**

Art. Nr.	Verpakking	Code steel
FI3902	5	-
 8 424775 401084		

FIEL MAND 40L H32-Ø43CM

Art. Nr.	Verpakking	Code steel
FI3900	5	-
 8 424775 401015		

FIEL MAND 55L H30-Ø55CM



Art. Nr.	Verpakking	Code steel
F13903	5	-

KUIPEN

FIEL KUIP 60L H23-Ø62CM



Art. Nr.	Verpakking	Code steel
F13904	5	-

FIEL MUURVOEDERBAK 25L 40X26/21CM



Art. Nr.	Verpakking	Code steel
F13906	5	-

FIEL RECHTHOEKIGE KUIP 30L 52X36/21CM



Art. Nr.	Verpakking	Code steel
F13907	5	-



Polet

CONSTRUCTION

Wie bouwgereedschap van topkwaliteit zoekt, zit gebeiteld bij gereedschapsfabrikant Polet. De doe-het-zelver die een degelijke basisuitrusting nodig heeft of de vakman die enkel de beste gespecialiseerde tools wil: beiden vinden al hun gereedschap in het ruime assortiment van Polet.

METSERS- EN STUKADOORSGEREEDSCHAP

TUBTRUGS GORILLA

GORILLA TUBS

- superflexibel
- UV- & vorstbestendig
- zéér sterk
- super sterke handvatten
- multifunctioneel



TUBTRUG GORILLA S 14L H23-Ø33



Art. Nr.	Verpakking	Code steel
TTGO14	10	-

TUBTRUG GORILLA 15L H16-Ø39



Art. Nr.	Verpakking	Code steel
TTGO15	5	-

TUBTRUG GORILLA M 26L H30-Ø39



Art. Nr.	Verpakking	Code steel
TTGO26	10	-



TUBTRUG GORILLA 35L H16-Ø57



Art. Nr.	Verpakking	Code steel
TTGO35	5	-



TUBTRUG GORILLA L 42L H33-Ø45



Art. Nr.	Verpakking	Code steel
TTGO42	10	-
 7 298480 000198		 

TUBTRUG GORILLA XL 75L H37-Ø57





Art. Nr.	Verpakking	Code steel
TTGO75	5	-
 7 298480 001256		 

GORILLA BUCKETS



GORILLA BUCKET 10L H20-Ø34



Art. Nr.	Verpakking	Code steel
TTGOB12	5	-
 7 298480 078722		 

GORILLA BUCKET 12L H28-Ø32





Art. Nr.	Verpakking	Code steel
TTGOB15	5	-
 7 298480 078890		 

METERSKUIPEN



FIEL METSERSKUIP 45L H36-Ø56CM



Art. Nr.	Verpakking	Code steel
FI3914	5	-
 8 424775 102011		 

FIEL METSERSKUIP 80L H39-Ø65CM





Art. Nr.	Verpakking	Code steel
FI3915	5	-
 8 424775 102028		 

TRUWELEN



TRUWEEL ROND 180X140MM



Art. Nr.	Verpakking	Code steel
081318	5	151315
		



TRUWEEL SCHERP 180X140MM



Art. Nr.	Verpakking	Code steel
081319	5	151315
		



TRUWEEL PARIJS 190X125MM



Art. Nr.	Verpakking	Code steel
083019	5	151315
		



VLOERDERSTRUWEEL 170X120MM



Art. Nr.	Verpakking	Code steel
083016	5	151315
		



POLIERTRUWEEL ROND 120X70MM



Art. Nr.	Verpakking	Code steel
086012	5	151320
		



POLIERTRUWEEL ROND 140X78MM



Art. Nr.	Verpakking	Code steel
086014	5	151320
		



POLIERTRUWEL ROND 160X86MM



Art. Nr.	Verpakking	Code steel
086016	5	151320
 5 410685 050774		



POLIERTRUWEL ROND 180X98MM



Art. Nr.	Verpakking	Code steel
086018	5	151320
 5 410685 050781		

KATTENTONGTRUWEL 160X55MM







Art. Nr.	Verpakking	Code steel
086216	5	151320
 5 410685 052693		

VOEGERS

VOEGER



Afmeting	Art. Nr.	Verpakking	Code steel	
140x8MM	085008	5	151320	 5410685050811
140x10MM	085010	5	151320	 5410685050828
140x12MM	085012	5	151320	 5410685050835
140x14MM	085015	5	151320	 5410685050842
140x16MM	085016	5	151320	 5410685052280

VOEGPALLET (RECHTS EN LINKS)



Art. Nr.	Verpakking	Code steel
085450	3	151320

PLAKTRUWELEN

PLAKTRUWEEL VIERKANT 260/130MM



Art. Nr.	Verpakking	Code steel
084027	5	151300

PLAKTRUWEEL ROND 290/110MM



Art. Nr.	Verpakking	Code steel
084029	5	151300

PLAKTRUWEEL ROND 350/115MM



Art. Nr.	Verpakking	Code steel
084035	5	151300

PLAKTRUWEEL ROND 500/115MM



Art. Nr.	Verpakking	Code steel
084050	3	151300

PLAKTRUWEEL ROND 600/115MM



Art. Nr.	Verpakking	Code steel
084060	3	151300

WATERPASSERS

WATERPASSERS

- nauwkeurig
- vergrote luchtbel
- schokvrij en stevig

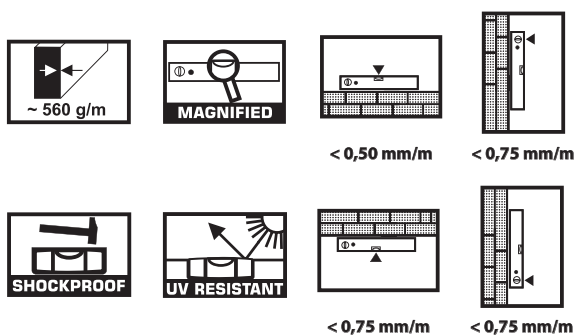

TRAPEZIUM WATERPAS



ALUMINIUM WATERPAS



MAGNETISCHE WATERPAS



MAGNEET



MAGNEET

TRAPEZIUM WATERPAS 2 LUCHTBELLEN



Afmeting	Art. Nr.	Verpakking	Code steel	
25CM	330200	1	-	 5410685879917
30CM	330201	5	-	 5410685804667
40CM	330202	5	-	 5410685804674
50CM	330203	5	-	 5410685804681
60CM	330204	5	-	 5410685804698
80CM	330206	5	-	 5410685804704
100CM	330208	1	-	 5410685879924

WATERPAS ALU 2 LUCHTBELLEN



Afmeting	Art. Nr.	Verpakking	Code steel	
30CM	337501	5	-	 5410685804582
40CM	337502	5	-	 5410685804599
50CM	337503	5	-	 5410685804605
60CM	337504	5	-	 5410685804612
80CM	337506	5	-	 5410685804629
100CM	337507	5	-	 5410685804636
120CM	337508	1	-	 5410685879931

MAGNEET WATERPAS 2 LUCHTBELLEN





Afmeting	Art. Nr.	Verpakking	Code steel	
60CM	337584	5	-	 5410685804827

KLEMHAKEN



KLEMHAAK 200MM



Art. Nr.	Verpakking	Code steel
081120	10	-
 5 410685 051108		



KLEMHAAK 200MM VIERKANT



Art. Nr.	Verpakking	Code steel
081121	1	-
 5 410685 869949		

KLEMHAAK 250MM





Art. Nr.	Verpakking	Code steel
081125	10	-
 5 410685 051115		  FULL METAL

METERSPRIEM

METERSPRIEM 180MM





Art. Nr.	Verpakking	Code steel
081200	10	-
 5 410685 051122		  FULL METAL

GRIFFEN



GRIFF DUBBEL 6/8MM



Art. Nr.	Verpakking	Code steel
080668	3	-
 5 410685 051191		  FULL METAL



GRIFF DUBBEL 10/12MM



Art. Nr.	Verpakking	Code steel
080602	3	-
 5 410685 051214		  FULL METAL



GRIFF DUBBEL 14/16MM



Art. Nr.	Verpakking	Code steel
080646	3	-
 5 410685 051238		  FULL METAL

GRIFF DUBBEL 18/20MM



Art. Nr.	Verpakking	Code steel
080680	1	-
 5 410685 868409		  FULL METAL

BITUMENSTEKERS

BITUMENSTEKER 130MM GESMEED



Art. Nr.	Verpakking	Code steel
025099	5	-

BITUMENSTEKER 130MM GESMEED T-ST 90CM



Art. Nr.	Verpakking	Code steel
025100	5	138282

BITUMENSTEKER 130MM GESMEED D-ST 1,5M



Art. Nr.	Verpakking	Code steel
025800	1	PT132150

BITUMENSTEKER 130MM GESMEED D-ST 2,5M



Art. Nr.	Verpakking	Code steel
025900	1	PT132250

BITUMENSTEKER 150MM



Art. Nr.	Verpakking	Code steel
343000	1	-

BITUMENSTEKER 150MM M/ST 135CM



Art. Nr.	Verpakking	Code steel
025400	5	141453

BITUMENSTEKER 150MM T-ST 95CM



Art. Nr.	Verpakking	Code steel
025500	5	138224

BITUMENSTEKER 300MM



Art. Nr.	Verpakking	Code steel
342000	5	-

BITUMENSTEKER 300MM M-ST 135CM



Art. Nr.	Verpakking	Code steel
025200	5	141453

BITUMENSTEKER 300MM T-ST 95CM



Art. Nr.	Verpakking	Code steel
025300	5	138224

BITUMENSTEKER 500MM



Art. Nr.	Verpakking	Code steel
344000	1	-

BITUMENSTEKER 500MM M/ST 135CM



Art. Nr.	Verpakking	Code steel
025600	5	141453

BITUMENSTEKER 500MM T-ST 95CM



Art. Nr.	Verpakking	Code steel
025700	5	138224

NIVELEERGEREEDSCHAP ALU

NIVELEERSCHUIVERS VOOR BETON EN BITUMEN

NIVELEERSCHUIVER 600MM



Art. Nr.	Verpakking	Code steel
300001	3	-

NIVELEERSCHUIVER 800MM



Art. Nr.	Verpakking	Code steel
300002	3	-

BITUMENVERDELER 700MM



Art. Nr.	Verpakking	Code steel
300070	2	-

RECHTE STEEL 1700X30MM ES



Art. Nr.	Verpakking	Code steel
141461	5	-

BETONVERDELERS MET VERSTELBARE HULS



BETONVERDELER 1000MM



Art. Nr.	Verpakking	Code steel
300030	3	-



BETONVERDELER 1200MM



Art. Nr.	Verpakking	Code steel
300031	3	-
 5 410685 804148		



VLOEBETON VERDELER 980X300MM



Art. Nr.	Verpakking	Code steel
300050	2	-
 5 410685 804223		

VERVANGHULS STEELHOUDER VOOR ART.300050





Art. Nr.	Verpakking	Code steel
300082	1	-
 5 410685 804230		

STELN VOOR NIVELEERGEREEDSCHAP

RECHTE STEEL 1700/32 ES VERNIST





Art. Nr.	Verpakking	Code steel
141460	5	-
 5 410685 805442		 

ALUMINIUM VLOERWISSERS INDUSTRIEEL



ALU-RUBBER VLOERWISSER 450MM



Art. Nr.	Verpakking	Code steel
300040	3	-
 5 410685 804162		

ALU-RUBBER VLOERWISSER 450MM M/ST 1,7M



Art. Nr.	Verpakking	Code steel
3000401	1	141461
 5 410685 880807		 

ALU-RUBBER VLOERWISSER 600MM VERSTERKT



Art. Nr.	Verpakking	Code steel
300041	3	-

ALU-RUB VLOERWISSER 600MM VERSTERKT M/ST 1,7M



Art. Nr.	Verpakking	Code steel
3000411	1	141461

ALU-RUBBER VLOERWISSER 800MM VERSTERKT



Art. Nr.	Verpakking	Code steel
300046	3	-

ALU-RUB VLOERWISSER 800MM VERSTERKT M/ST 1,7M



Art. Nr.	Verpakking	Code steel
3000461	1	141461

ASFALTHARKEN

BETON-ASFALTHARK 400MM/12T



Art. Nr.	Verpakking	Code steel
029030	3	-

BETON-ASFALTHARK 400MM/12T M/ST 135CM



Art. Nr.	Verpakking	Code steel
0290301	3	141453

BETON-ASFALTHARK 460MM/14T



Art. Nr.	Verpakking	Code steel
029035	3	-

BETON-ASFALTHARK 460MM/14T M/ST 135CM



Art. Nr.	Verpakking	Code steel
0290351	3	141453

ASFALTHARK 410MM/14T



Art. Nr.	Verpakking	Code steel
029040	3	-

ASFALTHARK 410MM/14T M/ST 135CM



Art. Nr.	Verpakking	Code steel
0290401	3	141453

ASFALTHARK 410MM/16T



Art. Nr.	Verpakking	Code steel
029041	3	-

ASFALTHARK 410MM/16T M/ST 135CM



Art. Nr.	Verpakking	Code steel
0290411	3	141453

BESTRATINGSGEREEDSCHAP

GRONDDAMMERS

VIERKANTE GRONDDAMMER 780X180X180MM 12,5KG



Art. Nr.	Verpakking	Code steel
027200	1	-

DALLENHAMERS

DALLENHAMER 3,50KG HOUTEN BLOK 195/90/55MM



Art. Nr.	Verpakking	Code steel
022000	2	151500

DALLENHAMER 3,25KG KUNSTSTOF BLOK



Art. Nr.	Verpakking	Code steel
022001	2	-

BESTRATINGSHAMERS-KASSEHAMERS

STRATENMAKERSHAMER



AFMETINGEN BEITEL BOVENAANZICHT:

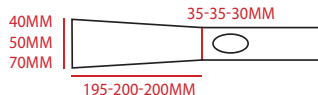

Gewicht kop/afmeting	Art. Nr.	Verpakking	Code steel	
1.50KG/40MM	2160040	2	151099	 5410685150009
2.00KG/50MM	2160050	2	151099	 5410685150016
2.50KG/70MM	2160070	2	151099	 5410685150023

STRATENMAKERSHAMER FIBER 5001



AFMETINGEN BEITEL BOVENAANZICHT:

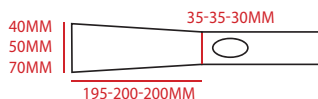

Gewicht kop/afmeting	Art. Nr.	Verpakking	Code steel	
1.50KG/40MM	2160040F	2	-	 5410685061916
2.00KG/50MM	2160050F	2	-	 5410685061213
2.50KG/70MM	2160070F	2	-	 5410685061923

DRAAGTANGEN

BOORDSTEENTANG 0-300MM VERSTELBAAR



Art. Nr.	Verpakking	Code steel
029022	1	-

VERVANGRUBBER BOORDSTEENTANG



Art. Nr.	Verpakking	Code steel
029022R	2	-

GESMEEDWALSTE PIKHOUWELEN

PIKHOUWEEL ROND 520MM/2.5KG



Art. Nr.	Verpakking	Code steel
0260225E	2	-

PIKHOUWEEL ROND 520MM/2,5KG ST ES 90CM



Art. Nr.	Verpakking	Code steel
02602251E	2	141890

PIKHOUWHEEL 520MM/2,5KG FIBER 5001 90CM



Art. Nr.	Verpakking	Code steel
0260225CF	1	EE900PC

PIKHOUWHEEL 520MM/2,5KG FIBER 9001 90CM



Art. Nr.	Verpakking	Code steel
0260225F	1	NS4/2

BEITELS

PUNTBEITELS

PUNTBEITEL 250MM



Art. Nr.	Verpakking	Code steel
080130	5	-

PUNTBEITEL 250MM + HANDBESCHERMING



Art. Nr.	Verpakking	Code steel
080130P	5	-

PUNTBEITEL 350MM



Art. Nr.	Verpakking	Code steel
080140	5	-





PUNTBEITEL 350MM + HANDBESCHERMING



Art. Nr.	Verpakking	Code steel
080140P	5	-

PUNTBEITEL 500MM







Art. Nr.	Verpakking	Code steel
080150	5	-
 5 410685 051016		  

PLATTE BEITELS





PLATTE BEITEL 200MM



Art. Nr.	Verpakking	Code steel
080320	5	-
 5 410685 051023		  





PLATTE BEITEL 300MM



Art. Nr.	Verpakking	Code steel
080330	5	-
 5 410685 051047		  





PLATTE BEITEL 300MM + HANDBESCHERMING



Art. Nr.	Verpakking	Code steel
080330P	5	-
 5 410685 856635		  





PLATTE BEITEL 400MM



Art. Nr.	Verpakking	Code steel
080340	5	-
 5 410685 051054		  

PLATTE BEITEL 400MM + HANDBESCHERMING



Art. Nr.	Verpakking	Code steel
080340P	5	-
 5 410685 856642		  

CARROSSERIEBEITEL

CARROSSERIEBEITEL 240MM



Art. Nr.	Verpakking	Code steel
080501	5	-

VOEGBEITELS

VOEGBEITEL 60MM



Art. Nr.	Verpakking	Code steel
080506	5	-

VOEGBEITEL 75MM



Art. Nr.	Verpakking	Code steel
080509	5	-

VOEGBEITEL 100MM



Art. Nr.	Verpakking	Code steel
080510C	1	-

BEITELDISPLAY

BEITELDISPLAY METAAL GEVULD



Art. Nr.	Verpakking	Code steel
250276	1	-

HANDBESCHERMING VOOR BEITELS

UNIVERSELE HANDBESCHERMING PLATTE BEITEL



Art. Nr.	Verpakking	Code steel
080121	5	-

UNIVERSELE HANDBESCHERMING PUNT EN VOEG BEITEL



Art. Nr.	Verpakking	Code steel
080122	5	-

HEFBOMEN EN STOOTIJZERS

HEFBOOM-STOOTIJZER FIBER 9001

STOOTIJZER 1,4M FIBER 9001



Art. Nr.	Verpakking	Code steel
181601	1	DBWG5

HEFBOOM MET VOET

AFBRAAKHEFBOOM 1,1MX28MM BEITEL/KLAUW



Art. Nr.	Verpakking	Code steel
028850	1	-

AFBRAAKHEFBOOM 1,5MX28MM BEITEL/KLAUW



Art. Nr.	Verpakking	Code steel
028851	1	-

HEFBOOM MET BOL EN PUNT

HEFBOOM BOL/PUNT 1,25MX28MM



Art. Nr.	Verpakking	Code steel
028225	1	-

HEFBOOM BOL/PUNT 1,5MX28MM



Art. Nr.	Verpakking	Code steel
028250	1	-

HEFBOOM MET BOL EN BEITEL

HEFBOOM BOL/BEITEL 1MX28MM



Art. Nr.	Verpakking	Code steel
028100	1	-

HEFBOOM BOL/BEITEL 1,25MX28MM



Art. Nr.	Verpakking	Code steel
028325	1	-

HEFBOOM BOL/BEITEL 1,5MX28MM



Art. Nr.	Verpakking	Code steel
028350	1	-

KASSEIHEFBOOM / STRAATMAKERSHEFBOOM ALU

STOOTIJZER 1,2MX28MM-400MM ALU



Art. Nr.	Verpakking	Code steel
028527AL	1	-

STOOTIJZER 1,2MX28MM-400MM ALU+SLAGDOP BL20T



Art. Nr.	Verpakking	Code steel
028537AL	1	-

KASSEIHEFBOOM / STRAATMAKERSHEFBOOM

STOOTIJZER 1,2MX28MM BEITEL VIERKANT LENGTE 400MM



Art. Nr.	Verpakking	Code steel
028520	1	-

STOOTIJZER 1,4MX28MM BEITEL VIERKANT LENGTE 400MM



Art. Nr.	Verpakking	Code steel
028540	1	-

STOOTIJZER 1,4MX28MM BEITEL VIERKANT LENGTE 1000MM



Art. Nr.	Verpakking	Code steel
028840	1	-

HEFBOOM MET KUNSTSTOF SLAGDOP 50MM

HEFBOOM 1,25M BEITEL+SLAGDOP BL20T 50MM



BL20T

Art. Nr.	Verpakking	Code steel
028327	1	-

KOEVOETEN

ZESKANT

KOEVOET ZESKANT 457X16MM-18"X5/8"



Art. Nr.	Verpakking	Code steel
090420	2	-

KOEVOET ZESKANT 431X19MM-17"X3/4"



Art. Nr.	Verpakking	Code steel
090430	2	-

KOEVOET ZESKANT 500X18MM



Art. Nr.	Verpakking	Code steel
090650	5	-

KOEVOET ZESKANT 600X18MM



Art. Nr.	Verpakking	Code steel
090660	5	-

KOEVOET ZESKANT 800X18MM



Art. Nr.	Verpakking	Code steel
090580	2	-

NAGELTREKKER ZESKANT 300X16



Art. Nr.	Verpakking	Code steel
090450	2	-

OVAAL

KOEVOET OVAAL







Afmeting	Art. Nr.	Verpakking	Code steel	
455x23x13	090845	2	-	 5410685856468
610x30x17	090860	2	-	 5410685856475
760x30x17	090876	2	-	 5410685856482
910x30x17	090890	2	-	 5410685856499
1100x30x17	090810	2	-	 5410685863886

VLAK





VLAKKE NAGELTREKKER 300X35X6



Art. Nr.	Verpakking	Code steel
090441	2	-
 5 410685 856536		  

VLAKKE NAGELTREKKER 455X35X6







Art. Nr.	Verpakking	Code steel
090442	2	-
 5 410685 856543		  

ALU





ALU KOEVOET 430MM



Art. Nr.	Verpakking	Code steel
090943AL	1	-
 5 410685 870860		  





ALU KOEVOET 480MM



Art. Nr.	Verpakking	Code steel
090948AL	1	-
 5 410685 870877		  

ALU KOEVOET 680MM



Art. Nr.	Verpakking	Code steel
090968AL	1	-
 5 410685 870884		  

HAMERS

HAMERS MET LOW VIBE STEEL

LOW-VIBE

- trilling absorberend
- hamerhoofd en handvat van gelegeerd staal
- chemisch bestand tegen oliën, solventen, zuren en logen
- ergonomische vormgeving en gemakkelijke handgreep voor efficiënt en comfortabel gebruik
- magnetisch hamerhoofd voor nagels



KLAUWHAMER LOW VIBE SYSTEM 850GR 320MM



Art. Nr.	Verpakking	Code steel
181880	1	-

KLAUWHAMER LOW VIBE SYSTEM 725GR 320MM



Art. Nr.	Verpakking	Code steel
181881	1	-

BANKHAMER LOW VIBE SYSTEM 850GR 320MM



Art. Nr.	Verpakking	Code steel
181885	1	-

DAKDEKKERSHAMER LOW VIBE SYSTEM 865GR



Art. Nr.	Verpakking	Code steel
181890	1	-

KLAUWHAMERS

KLAUWHAMER 500G FIBER 9001



Art. Nr.	Verpakking	Code steel
181481	4	-

KLAUWHAMER 560G FIBER 5001



Art. Nr.	Verpakking	Code steel
FC181480	1	-

KLAUWHAMER 500GR FSC 100% HICKORY



Hickory
Wood

Art. Nr.	Verpakking	Code steel
081461	6	151101



BANKHAMERS-DIN 1041

BANKHAMER FIBER 9001



Gewicht kop	Art. Nr.	Verpakking	Code steel	
200G	181497	3	-	 5410685060216
300G	181493	3	-	 5410685060223
500G	181495	3	-	 5410685060230
800G	181498	3	-	 5410685060254
1000G	181490	1	-	 5410685060261
1500G	181491	1	-	 5410685060278
2000G	181492	1	-	 5410685060285

BANKHAMER FIBER 5001



Gewicht kop	Art. Nr.	Verpakking	Code steel	
300G	FC181493	3	-	 5410685855072
500G	FC181495	3	-	 5410685855089
800G	FC181498	3	-	 5410685855096
1000G	FC181490	1	-	 5410685855102
1500G	FC181491	1	-	 5410685855119

BANKHAMER FSC 100% DIN1041 HICKORY



Gewicht kop	Art. Nr.	Verpakking	Code steel	
300G	081473	5	151130	 5410685051627
500G	081475	5	151132	 5410685051634
800G	081478	5	151135	 5410685051658
1000G	081480	5	151135	 5410685051665
1500G	081481	4	151138	 5410685051672

VOORHAMERS-DIN 6475 EN 1042

VOORHAMER DWARS FIBER 9001 90CM



Gewicht kop	Art. Nr.	Verpakking	Code steel	
3KG	181433	1	-	 5410685060155
4KG	181434	1	-	 5410685060162
5KG	181435	1	-	 5410685060179
6KG	181436	1	-	 5410685060186
8KG	181428	1	-	 5410685805961
10KG	181430	1	-	 5410685060193

VOORHAMER DWARS FIBER 5001 90CM



Gewicht kop	Art. Nr.	Verpakking	Code steel	
3KG	FC181433	1	-	 5410685855201
4KG	FC181434	1	-	 5410685855218
5KG	FC181435	1	-	 5410685855225

VOORHAMER 4KG FSC 100% DWARSE SNEDE HICKORY 90CM



Art. Nr.	Verpakking	Code steel
081434	1	141995

VOORHAMER VIERKANT FIBER 9001 90CM



Gewicht kop	Art. Nr.	Verpakking	Code steel	
3KG	181413	1	-	 5410685060032
4KG	181414	1	-	 5410685060049
5KG	181415	1	-	 5410685060056
6KG	181416	1	-	 5410685060063
8KG	181418	1	-	 5410685810774
10KG	181410	1	-	 5410685060087

VOORHAMER VIERKANT FIBER 5001 90CM





Gewicht kop	Art. Nr.	Verpakking	Code steel	
3KG	FC181413	1	-	 5410685855171
4KG	FC181414	1	-	 5410685855188
5KG	FC181415	1	-	 5410685855195

VOORHAMER VIERKANT DIN6475 HICKORY 90CM



Hickory
Wood



Gewicht kop	Art. Nr.	Verpakking	Code steel	
3KG	081413	1	141995	 5410685051399
4KG	081414	1	141995	 5410685052730
5KG	081415	1	141995	 5410685051412



MOKERS-DIN 6475

MOKER FIBER 9001



Gewicht kop	Art. Nr.	Verpakking	Code steel	
1KG	181450	3	-	 5410685060292
1,25KG	181453	3	-	 5410685060308
1,5KG	181455	2	-	 5410685060315
2KG	181452	2	-	 5410685060322

MOKER FIBER 5001



Gewicht kop	Art. Nr.	Verpakking	Code steel	
1KG	FC181450	3	-	 5410685855133
1,25KG	FC181453	3	-	 5410685855140
1,5KG	FC181455	2	-	 5410685855157
2KG	FC181452	2	-	 5410685855164

MOKER FSC 100% DIN6475 HICKORY







Gewicht kop	Art. Nr.	Verpakking	Code steel	
1KG	081442	4	151102	 5410685051559
1,25KG	081443	4	151102	 5410685051566
1,5KG	081444	4	151103	 5410685051573
2KG	081445	4	151103	 5410685051580

NUPLA SOFTFACE HAMERS

POWERDRIVE-TERUGSLAGVRIJ

POWER DRIVE





Afmeting/Gewicht kop	Art. Nr.	Verpakking	Code steel	
40MM 800GR-C	SF1C	1	-	 5410685803073
50MM 1000GR-C	SF2C	1	-	 5410685803080
60MM 1300GR-C	SF3C	1	-	 5410685803097
70MM 1600GR-C	SF4C	1	-	 5410685803103



DOPPEN OP KAART



NUPLA DOP BL 50MM HARD-ZWART



Art. Nr.	Verpakking	Code steel
BL20H	1	-
 5 410685 854396		 



NUPLA DOP BL 50MM MEDIUM-ROOD



Art. Nr.	Verpakking	Code steel
BL20M	1	-
 5 410685 854402		 



VERVANGDOP 50MM VR HEFBOOM 028327



Art. Nr.	Verpakking	Code steel
BL20T	1	-
 5 410685 854440		 



NUPLA DOP BL 75MM MEDIUM-ROOD



Art. Nr.	Verpakking	Code steel
BL30M	1	-
 5 410685 854549		 

NUPLA DOP BL 75MM ZACHT-GROEN



Art. Nr.	Verpakking	Code steel
BL30T	1	-
 5 410685 854587		 



Polet

CLEANING

Ons assortiment cleaning heeft alles in huis om het hardnekkigste vuil aan te pakken.

Bezems met PVC haren voor buitengebruik en in water of met haren van kosvezels voor dagelijks gebruik in huis. Onze straatbezems van sherbro met baleinen, voorzien van een extra dikke steel, zijn dan weer ideaal voor het schrapen en vegen van zowel fijn als grof vuil. Ga zelf onkruid te lijf met onze bezem met PVC haren en staaldraad. Iedereen vindt zijn gading in ons assortiment afvalgrijptangen voor het oprapen van allerlei vuil. Onze vloertrekkers zijn van Belgische makelij en van topkwaliteit!

BEZEMS

EFFEN ONDERGROND

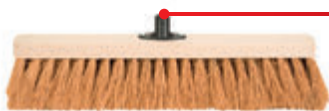

KOKOS

- veegt goed en is goedkoper
- gebruik op droge plaatsen: loodsen, schuren, garages, binnengebruik



ARENKA / ELASTON

- beter bestand tegen water dan kokos
- ideaal voor terrassen en binnengebruik
- klit niet

ONEFFEN ONDERGROND



PVC

- bestand tegen water
- geschikt om te schrobben
- lange pvc: geschikt om grotere hoeveelheden te verwerken



BASSINE

- gebruik op droge plaatsen: loodsen, schuren, garages, binnengebruik
- natuurlijke vezels van goeie kwaliteit



75% BAHIA

- natuurlijke vezels van uitstekende kwaliteit
- bestand tegen water, rot of beschimmelt niet



BAHIA MET PVC

- bestand tegen water
- werpt minder stof op dan PVC
- ideaal voor bouwwerven en landbouw



SHERBRO MET BALEINEN

- stijve en sterke vezels, vervormen niet door vocht
- ideaal voor bouwwerven en landbouw
- geschikt voor ruw werk en afschrapen van vuil



PVC MET STAALDRAAD

- bestand tegen water
- ideaal voor bouwwerven
- robuuste stalen steelhouder

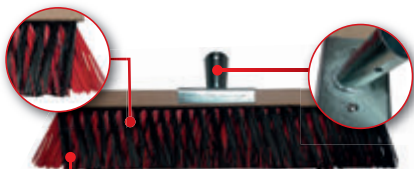

GEKRUISTE PVC

- bestand tegen water
- geschikt om te schrobben
- werpt minder stof op door de gekruiste PVC haren
- robuuste stalen steelhouder



BULLDOZER BEZEM PVC HAREN

- geschikt voor binnengebruik
- dankzij de speciale uiteinden blijft het vuil beter voor de bezem liggen

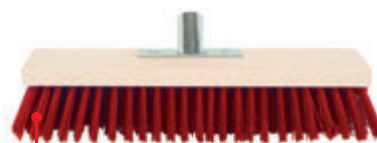

STRAATBEZEM SYNTHETISCH

- bestand tegen water
- geschikt om te schrobben en grofvuil op te kuisen



TUIN-TERRASBEZEM PVC

- geschikt voor gebruik in de tuin en rondom het huis
- bestand tegen water
- geschikt om te schrobben



GEMEENTEBEZEM SHERBRO

- stijve en sterke vezels, vervormen niet door vocht
- ideaal voor bouwwerven en landbouw
- geschikt voor ruw werk en afschrapen van vuil



HEKSENBENZEM GEBONDEN NATUURVEZELS



- geschikt voor optimaal veegresultaat op ongelijke ondergronden

BEZEMS EN VEGERS

HANDBORSTELS



HANDBORSTEL 320MM ELASTON ROOD



Art. Nr.	Verpakking	Code steel
401013	5	-
 5 410685 831137		



HANDBORSTEL 320MM ARENGA/ELASTON ROOD



Art. Nr.	Verpakking	Code steel
401012	5	-
 5 410685 831120		



HANDBORSTEL 320MM KOKOS



Art. Nr.	Verpakking	Code steel
401014	5	-
 5 410685 831144		



HANDBORSTEL 400MM KOKOS MET LANGE STEEL



Art. Nr.	Verpakking	Code steel
401015	5	-
 5 410685 889688		



TUINBORSTEL M/ST KORT



Art. Nr.	Verpakking	Code steel
401032	5	-
 5 410685 831076		

TUIN EN KETELBORSTEL VLAK



Art. Nr.	Verpakking	Code steel
401031	5	-
 5 410685 831069		

TUINBORSTEL MET HANDVAT



Art. Nr.	Verpakking	Code steel
401034	5	-

GROENTENBORSTEL NATUURFIBER



Art. Nr.	Verpakking	Code steel
401041	5	-

GROENTENBORSTEL WIT/ZWART



Art. Nr.	Verpakking	Code steel
401042	5	-

GEREEDSCHAPSBORSTEL ELASTON



Art. Nr.	Verpakking	Code steel
401035	5	-

GEREEDSCHAPSBORSTELTJE



Art. Nr.	Verpakking	Code steel
401070	5	-



HANDBORSTEL STAAL 280MM



Art. Nr.	Verpakking	Code steel
401080	1	-



HANDBORSTEL STAAL MET HANDVAT



Art. Nr.	Verpakking	Code steel
401085	1	-
 5 410685 875810		



HANDBORSTEL MET VUILBLIK POLYPROPYLEEN



Art. Nr.	Verpakking	Code steel
401021	5	-
 5 410685 829677		



VUILBLIK VERZINKT



Art. Nr.	Verpakking	Code steel
401022	5	-
 5 410685 831199		



SET VUILBLIK GALVA MET KOKO BORSTEL



Art. Nr.	Verpakking	Code steel
250388	5	-
 5 410685 884270		

KOLENSCHOP M/ST 25 CM





Art. Nr.	Verpakking	Code steel
401060	5	-
 5 410685 834831		

ZAALBEZEMS

ZAALBEZEM 400MM KOKOS 7 RIJEN



Art. Nr.	Verpakking	Code steel
402051	4	-
 5 410685 831403		

ZAALBEZEM 400MM KOKOS 7 RIJEN M/ST 1,4M



Art. Nr.	Verpakking	Code steel
4020511	2	143740

ZAALBEZEM 600MM KOKOS 7 RIJEN



Art. Nr.	Verpakking	Code steel
402052	4	-

ZAALBEZEM 600MM KOKOS 7 RIJEN M/ST 1,4M



Art. Nr.	Verpakking	Code steel
4020521	2	143740

ZAALBEZEM 800MM KOKOS 7 RIJEN



Art. Nr.	Verpakking	Code steel
402053	4	-

ZAALBEZEM 800MM KOKOS 7 RIJEN M/ST 1,4M



Art. Nr.	Verpakking	Code steel
4020531	2	143740



ZAALBEZEM 100CM KOKOS 7 RIJEN



Art. Nr.	Verpakking	Code steel
402054	4	-



ZAALBEZEM 100CM KOKOS 7 RIJEN M/ST 1,4M



Art. Nr.	Verpakking	Code steel
4020541	2	143740
 5 410685 834619		



ZAALBEZEM 400MM ARENGA/ELASTON 6 RIJEN



Art. Nr.	Verpakking	Code steel
402041	4	-
 5 410685 831298		



ZAALBEZEM 400MM ARENGA/ELASTON 6 RIJEN M/ST 1,4M



Art. Nr.	Verpakking	Code steel
4020411	2	143740
 5 410685 831304		



ZAALBEZEM 600MM ARENGA/ELASTON 6 RIJEN



Art. Nr.	Verpakking	Code steel
402042	4	-
 5 410685 831328		

ZAALBEZEM 600MM ARENGA/ELASTON 6 RIJEN M/ST 1,4M





Art. Nr.	Verpakking	Code steel
4020421	2	143740
 5 410685 831380		

STRAAT-EN TERRASBEZEMS

BULLDOZER BEZEM 320MM



Art. Nr.	Verpakking	Code steel
1007	4	-
 5 410685 200070		

BULLDOZER BEZEM 320MM M/ST 1,5M



Art. Nr.	Verpakking	Code steel
10071	2	143663

BULLDOZER BEZEM 320MM FIBER 3001 1,5M



Art. Nr.	Verpakking	Code steel
FH10071	1	FH143652

BULLDOZER BEZEM 550MM



Art. Nr.	Verpakking	Code steel
1010	4	-

BULLDOZER BEZEM 550MM M/ST 1,5M



Art. Nr.	Verpakking	Code steel
10101	2	143663

STRAATBEZEM 320MM PIASSAVA



Art. Nr.	Verpakking	Code steel
1021	4	-



STRAATBEZEM 320MM PIASSAVA M/ST 1,5M



Art. Nr.	Verpakking	Code steel
10211	2	143663



STRAATBEZEM 320MM PIASSAVA M/ST FSC 100% 1,5M



Art. Nr.	Verpakking	Code steel
10211S	1	143650
 5 410685 874035		



STRAATBEZEM 400MM SYNTHETISCH



Art. Nr.	Verpakking	Code steel
1031	4	-
 5 410685 801598		



STRAATBEZEM 400MM SYNTHETISCH M/ST 1,5M



Art. Nr.	Verpakking	Code steel
10311	2	143663
 5 410685 801185		 



STRAATBEZEM 290MM ROOD



Art. Nr.	Verpakking	Code steel
403011	4	-
 5 410685 830253		



STRAATBEZEM 290MM ROOD M/ST 1,4M



Art. Nr.	Verpakking	Code steel
4030111	2	143740
 5 410685 830291		 

ANKERSCHUURBORSTEL 230MM MET KWALITATIEVE STEELHOUDER



Art. Nr.	Verpakking	Code steel
410230	1	-
 5 410685 890691		 

ANKERSCHUURBORSTEL 230MM M/ST 140CM



Art. Nr.	Verpakking	Code steel
4102301	1	143740

TUIN-TERRASBEZEM 310MM PVC ROOD



Art. Nr.	Verpakking	Code steel
403041	4	-

TUIN-TERRASBEZEM 310MM PVC ROOD M/ST 1,4M



Art. Nr.	Verpakking	Code steel
4030411	2	143740

VLAKKE BANKIRAIBEZEM 300MM PVC ROOD



Art. Nr.	Verpakking	Code steel
403061	4	-

VLAKKE BANKIRAIBEZEM 300MM PVC ROOD M/ST 1,4M



Art. Nr.	Verpakking	Code steel
4030611	2	143740



STRAATBEZEM 310MM PIASSAVA



Art. Nr.	Verpakking	Code steel
403081	5	-



STRAATBEZEM 310MM PIASSAVA M/ST 1,5M



Art. Nr.	Verpakking	Code steel
4030811	2	143650
 5 410685 855539		 



STRAATBEZEM 300MM FSC 100% KORTE PVC



Art. Nr.	Verpakking	Code steel
407010	5	-
 5 410685 869109		



STRAATBEZEM 300MM FSC 100% KORTE PVC M/ST 1,5M



Art. Nr.	Verpakking	Code steel
4070101	5	143662
 5 410685 869185		 



STRAATBEZEM 300MM FSC 100% LANGE PVC



Art. Nr.	Verpakking	Code steel
407020	5	-
 5 410685 869116		



STRAATBEZEM 300MM FSC 100% LANGE PVC M/ST 1,5M



Art. Nr.	Verpakking	Code steel
4070201	5	143662
 5 410685 869192		 

STRAATBEZEM 450MM FSC 100% LANGE PVC



Art. Nr.	Verpakking	Code steel
407070	5	-
 5 410685 883334		

STRAATBEZEM 450MM FSC 100% LANGE PVC M/ST 1,5M



Art. Nr.	Verpakking	Code steel
4070701	5	143662

STRAATBEZEM 300MM FSC 100% BASSINE



Art. Nr.	Verpakking	Code steel
407030	1	-

STRAATBEZEM 300MM FSC 100% BASSINE M/ST 1,5M



Art. Nr.	Verpakking	Code steel
4070301	5	143662

STRAATBEZEM 300MM FSC 100% BAHIA 75%



Art. Nr.	Verpakking	Code steel
407040	5	-

STRAATBEZEM 300MM FSC 100% BAHIA 75% M/ST 1,5M



Art. Nr.	Verpakking	Code steel
4070401	5	143662



STRAATBEZEM 300MM FSC 100% SHERBRO/BALLEINEN



Art. Nr.	Verpakking	Code steel
407050	5	-

STRAATBEZEM 300MM FSC 100% SHERBRO/BALLEIN M/ST 1,5M



Art. Nr.	Verpakking	Code steel
4070501	5	143662
 5 410685 869222		

SHERBRO MET BALEINEN

- schrapen en vegen
- ideaal voor fijn & grof vuil
- extra dikke steel (+35%)



STRAATBEZEM 300MM FSC 100% BAHIA/PVC



Art. Nr.	Verpakking	Code steel
407060	5	-

STRAATBEZEM 300MM FSC 100% BAHIA/PVC M/ST 1,5M



Art. Nr.	Verpakking	Code steel
4070601	5	143662

GEMEENTEBEZEM 450MM FSC 100% SHERBRO



Art. Nr.	Verpakking	Code steel
407080	5	-

GEMEENTEBEZEM 450MM FSC 100% SHERBRO M/ST 1,5M



Art. Nr.	Verpakking	Code steel
4070801	5	-

STRAATBEZEM 300MM FSC 100% SHERBRO/BALEINEN



Art. Nr.	Verpakking	Code steel
407150	5	-

STRAATBEZEM 300MM FSC 100% SHERBRO/BALEINEN M/ST 1,5M



Art. Nr.	Verpakking	Code steel
4071501	5	143662

STRAATBEZEM 300MM FSC 100% SHERBRO/PVC



Art. Nr.	Verpakking	Code steel
407160	5	-

STRAATBEZEM 300MM FSC 100% SHERBRO/PVC M/ST 1,5M



Art. Nr.	Verpakking	Code steel
4071601	5	143662

STRAATBEZEM 320MM M/ST FIBER 3001 1,5M



Art. Nr.	Verpakking	Code steel
FH10211	2	FH143652

BEZEM 270MM-PP ROOD+STAALDRAAD 75MM



Art. Nr.	Verpakking	Code steel
409010	5	-

BEZEM 270MM-PP ROOD+STAALDRAAD 75MM M/ST 1,5M



Art. Nr.	Verpakking	Code steel
4090101	5	-

BEZEM 400MM-PP ROOD+ZWART 70MM



Art. Nr.	Verpakking	Code steel
409020	5	-

BEZEM 400MM-PP ROOD+ZWART 70MM M/ST 1,5M



Art. Nr.	Verpakking	Code steel
4090201	5	-

BEZEM 400MM-PP ROOD+ZWART 70MM M/ST FIBER 3001 1,5M



Art. Nr.	Verpakking	Code steel
FH4090201	5	FH143652

STRAATBEZEM 300MM PVC M/ST FIBER 3001 1,5M



Art. Nr.	Verpakking	Code steel
FH4030711R	2	FH143652

STRAATBEZEM 400MM PVC M/ST FIBER 3001 1,5M



Art. Nr.	Verpakking	Code steel
FH4030711	2	FH143652

HEKSENBEZEM 300/400 M/ST 1M





Art. Nr.	Verpakking	Code steel
4080101	5	-

GORILLA BROOMS



GORILLA BROOM STEEL 147CM



Art. Nr.	Verpakking	Code steel
BRGO147YH	1	-
 7 298480 072478		



GORILLA BROOM SMALL 36CM



Art. Nr.	Verpakking	Code steel
BRGO36S	3	-
 7 298480 073154		



DISPLAY GORILLA BROOM SMALL - 18X BRGO147YH + 18X BRGO36S



Art. Nr.	Verpakking	Code steel
250398	1	-
 5 410685 886038		



GORILLA BROOM LARGE 54CM



Art. Nr.	Verpakking	Code steel
BRGO54L	3	-
 7 298480 073772		

DISPLAY GORILLA BROOM LARGE - 18X BRGO147YH + 18X BRGO54L



Art. Nr.	Verpakking	Code steel
250397	1	-
 5 410685 886021		

STRAATREINIGINGSMATERIAAL

GRIJPTANGEN EN DRAAGRING

AFVALGRIJPTANG 850MM ALUMINIUM



Art. Nr.	Verpakking	Code steel
1016	5	-

SET VERVANGDOPPEN AFVALGRIJPTANG ALU 850MM



Art. Nr.	Verpakking	Code steel
1016D	1	-

PAPIERGRIJPTANG 870MM



Art. Nr.	Verpakking	Code steel
1011	5	-

AFVALGRIJPTANG 900MM



Art. Nr.	Verpakking	Code steel
1014	5	-

SET VERVANGDOPPEN AFVALGRIJPTANG 900MM



Art. Nr.	Verpakking	Code steel
1014D	1	-

AFVALGRIJPTANG 900MM



Art. Nr.	Verpakking	Code steel
1038	5	-

SET VERVANGDOPPEN AFVALGRIJPTANG 900MM



Art. Nr.	Verpakking	Code steel
1038D	1	-

BLIKJESGRIJPTANG 920MM



Art. Nr.	Verpakking	Code steel
1012	5	-

DRAAGRING VUILZAK 400MM



Art. Nr.	Verpakking	Code steel
1033	5	-



VLOERWISSERS

- gegalvaniseerd roestvrij stalen frame

- de speciale waterrand voorkomt dat water over het frame spat

- gepatenteerd sluitsysteem met ingebouwde schroef en moer

- extra stevige bevestiging



- **NATUURRUBBER:** geeft de sterkte aan de vloerwisser en voorkomt dat er zich bacteriën in vormen
- **SLIJTVAST:** gaat langer mee
- **STERK & FLEXIBEL:** hoge weerstand tegen scheuren en wrijving
- **HOGE ELASTICITEIT:** het rubber gaat diep in oneffen oppervlaktes en herneemt zijn vorm na gebruik
- **PERFECTE DICHTHEID** en bestand tegen water
- voor gebruik op **VERSCHILLENDE ONDERGRONDEN:** effen als oneffen oppervlaktes zoals beton, steen, tegels en marmer
- **DUBBELE RUBBEREN BOORD:** dubbel efficiënt, dubbel resultaat

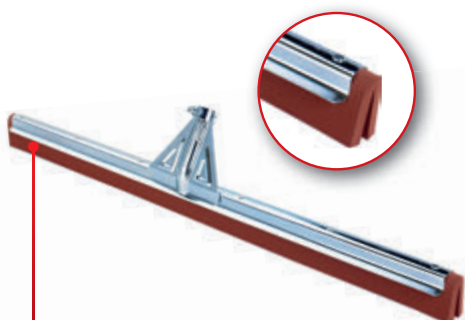

INDUSTRIËLE VLOERWISSER

- speciale waterrand
- bevat neopreen om weerstand te bieden aan olie, zuren, vetten en detergents
- gebruik in industrie, garages en onderhoudsvoorzieningen
- versterkte dul



HYGIËNISCHE VLOERWISSER

- speciale waterrand
- gebruik wanneer hygiëne belangrijk is
- door zijn witte kleur is het duidelijk zichtbaar wanneer de vloerwisser goed gereinigd is of moet vervangen worden
- gebruik in zwembaden, keukens, badkamers, restaurant en sauna's

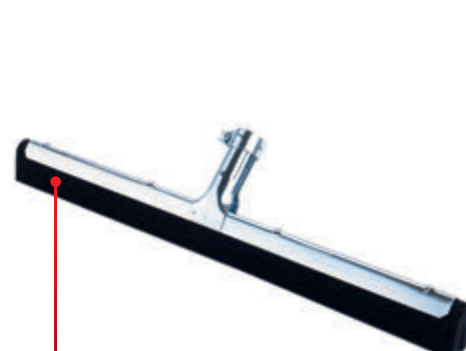



STANDAARD VLOERWISSER

- veelzijdig gebruik wanneer olie- en hittebestendigheid niet nodig zijn
- gebruik in winkels, scholen, openbare plaatsen, terrassen, kelders, opritten

VLOERWISSERS



VLOERWISSER NATUUR ZWART



Afmeting	Art. Nr.	Verpakking	Code steel	
350MM	404010	5	-	 5410685881552
450MM	404011	4	-	 5410685831946
550MM	404012	4	-	 5410685832011

VLOERWISSER NATUUR ZWART M/ST 1,5M



Afmeting	Art. Nr.	Verpakking	Code steel	
350MM	4040101	5	143740	 5410685881569
450MM	4040111	2	143740	 5410685831977
550MM	4040121	2	143740	 5410685832035



VLOERWISSER NATUUR ROOD



Afmeting	Art. Nr.	Verpakking	Code steel	
550MM	404022	4	-	 5410685832110
750MM	404023	4	-	 5410685832172

VLOERWISSER NATUUR ROOD M/ST 1,5M



Afmeting	Art. Nr.	Verpakking	Code steel	
550MM	4040221	2	143740	 5410685832134
750MM	4040231	2	143740	 5410685832202

VLOERWISSER NATUUR WIT



Afmeting	Art. Nr.	Verpakking	Code steel	
450MM	404051	5	-	 5410685881590
550MM	404052	5	-	 5410685881613

VLOERWISSER NATUUR WIT M/ST 1,5M



Afmeting	Art. Nr.	Verpakking	Code steel	
450MM	4040511	5	143740	 5410685881606
550MM	4040521	5	143740	 5410685881620



Polet

STELLEN EN TOEBEHOREN

Bij het ontwerp van onze producten en stelen is veiligheid steeds onze eerste zorg. Meer dan ooit besteden we aandacht aan de kwaliteit en keuze van de houtsoort die perfect past bij onze gereedschappen. Van essenhout, kwalitatief goed en veel gebruikt, tot beukenhout, goedkoper maar perfect als gereedschapssteel. Voor het zwaardere werk, zoals hamers, gebruiken we hickory, een bijzonder sterke veerkrachtige houtsoort. In onze Polet Traditional reeks vindt u zelf ook een aantal schoppen, spades en hakken met deze houtsoort.

Voor professioneel gereedschap worden meer en meer stelen van glasvezel gebruikt. Die bestaan uit miljoenen haarfijne glasvezels die met epoxyharsen worden samengevoegd tot een supersterke steel. Daarnaast vindt u bij ons ook steeds de nodige toebehoren om uw gereedschappen op te hangen of van een vervangsteel te voorzien.

STELLEN



BOLSTEEEL



IJZER
HANDVAT



KUNSTSTOF
HANDVAT



D-STEEEL



T-STEEEL

INGEWERKTE
RECHTE HILT



FIBER 3001

UNIEK: ERGONOMISCH HANDVAT
LIGT BETER IN DE HAND



FIBER 5001



FIBER 9001

Een **glasvezelsteel** is uit miljoenen haarfijne glasvezels getrokken en door middel van een epoxyhars uitgehard met microgolven, zodat er geen luchtbelvorming tussen de vezels zit. Hierdoor worden in de lengte gebarsten stelen uitgesloten.

SPADESTELLEN

- essenhout: de nerven lopen rechtdradig, over heel de lengte van de steel
- beukenhout: te herkennen aan de donkere stipjes op het hout
- gevernist: maakt de steel gladder, wat een aangename gevoel geeft en de vochtinwerking van regen of zweet tegenhoudt, waardoor je steel langer meegaat
- lengtes tussen 70 en 115 centimeter
- diameter: Ø 36mm, Ø 37mm, Ø 38mm, Ø 41mm en Ø 44mm
- handvat: T-handvat, D-handvat of afgerond

RAAK- EN BORSTELSTELLEN

- lengtes tussen 120 tot 170 centimeter
- diameter: Ø 24mm of Ø 28mm
- rechtdradig, gladgeschuurd hout van A-kwaliteit, tropisch hardhout of essenhout

BIJL- EN HAMERSTELLEN

- let (altijd, maar zeker bij bijlen en hamers) goed op de juiste diameter en aanscherping van de steel
- essenhout en Hickory (nog harder dan es, zeer geschikt voor het zwaardere werk)



SCHOP- EN BATSSTELLEN

- essenhout: goede stevigheid en een zekere flexibiliteit
- beukenhout: meer onderhevig aan vochtinwerking, met kromtrekken tot gevolg
- gebogen steel: de schop ligt mooi in evenwicht en beperkt de nodige kracht bij het scheppen
- lengtes tussen 95 en 130 centimeter
- diameter: Ø 41mm

RIEKSTELLEN

- handvat: T-handvat, D-handvat of afgerond
- met of zonder veerbus
- lengtes tussen 85 en 135 centimeter
- diameter: Ø 36mm, Ø 39mm en Ø 41mm

VORKSTELLEN

- met of zonder veerbus
- lengtes tussen 135 en 165 centimeter
- diameter: Ø 36mm

GLASVEZELSTELLEN

- fiber 3001: 3x sterker dan hout
- fiber 5001: 5x sterker dan hout
- fiber 9001: 10x sterker dan hout

GEBOGEN

RECHT



The mark of responsible forestry

Enkel het FSC®-hout, aangeduid met "FSC" in de productomschrijving in deze catalogus, komt uit duurzaam beheerde bossen die onder de FSC®-reglementering vallen. Polet zal nooit hout importeren dat afkomstig is uit wildkap van tropisch regenwoud.

SPADESTELLEN

POLET TRADITIONAL

TRADITIONAL SPADESTEEL T-ST 74 HICKORY



Art. Nr.	Verpakking	Code steel
PT131370H	1	-
 5 410685 873632		

TRADITIONAL SPADESTEEL T-ST 85 HICKORY



Art. Nr.	Verpakking	Code steel
PT131385H	1	-
 5 410685 881316		

TRADITIONAL SPADESTEEL T-ST 95 HICKORY



Art. Nr.	Verpakking	Code steel
PT131295H	1	-
 5 410685 874936		

TRADITIONAL SPADESTEEL T-ST 95 ES



Art. Nr.	Verpakking	Code steel
PT131295	1	-
 5 410685 874929		

TRADITIONAL PIJPSPADESTEEL 150CM D-HANDVAT



Art. Nr.	Verpakking	Code steel
PT132150	1	-
 5 410685 879627		

TRADITIONAL BOOMSPADESTEEL T-ST 85 HICKORY



Art. Nr.	Verpakking	Code steel
PT137385	1	-
 5 410685 873144		

TRADITIONAL BOOMSPADESTEELE T-ST 90 HICKORY



Art. Nr.	Verpakking	Code steel
PT137390	1	-
 5 410685 876343		

TRADITIONAL PLANTSPADESTEELE T-ST 90 HICKORY



Art. Nr.	Verpakking	Code steel
PT137390H	1	-
 5 410685 881125		

FIBER 3001 STELEN

DAMESSPADESTEELE T 900/38 FIBER 3001



Art. Nr.	Verpakking	Code steel
FH136290	5	-
 5 410685 855805		

T-SPADESTEELE 950/41 FIBER 3001



Art. Nr.	Verpakking	Code steel
FH131395	5	-
 5 410685 855799		

BOLSTEELE GEBOGEN 1150/39 FIBER 3001





Art. Nr.	Verpakking	Code steel
FH136305	5	-
 5 410685 855812		

T-STEEL



T-SPADESTEEEL 700/41



Art. Nr.	Verpakking	Code steel
131370	1	-
 5 410685 817162		



T-SPADESTEEEL 850/41 ES



Art. Nr.	Verpakking	Code steel
131285	10	-
 5 410685 100011		



T-SPADESTEEEL 950/41 ES



Art. Nr.	Verpakking	Code steel
131295	10	-
 5 410685 100035		



T-SPADESTEEEL 1000/41 ES



Art. Nr.	Verpakking	Code steel
131200	10	-
 5 410685 100042		



T-SPADESTEEEL 900/36 CONISCH



Art. Nr.	Verpakking	Code steel
132390CB	2	-
 5 410685 199992		

T-DAMESSPADESTEEEL 900/38



Art. Nr.	Verpakking	Code steel
136290	10	-
 5 410685 100110		

T-DAMESSPADESTEEL 900/37 BEUK



Art. Nr.	Verpakking	Code steel
136290CB	2	-

T-BOOMSPADESTEEL 850/44 ES



Art. Nr.	Verpakking	Code steel
137285	5	-

T-BOOMSPADESTEEL 950/44 ES



Art. Nr.	Verpakking	Code steel
137295	5	-

T-BITUMENSTEKERSTEEL 950/36



Art. Nr.	Verpakking	Code steel
138224	5	-

SPADESTEEL 750/36 ES ZH-SPADE



Art. Nr.	Verpakking	Code steel
1920010	10	-

SPADESTEEL 850/36 ES ZH-SPADE





Art. Nr.	Verpakking	Code steel
1920015	10	-

T-STEEL GEBOGEN



T- SPADESTEEL GEBOGEN 950/41 ES



Art. Nr.	Verpakking	Code steel
135395	10	-
 5 410685 100097		



T-SPADESTEEL LICHT GEBOGEN 950/41



Art. Nr.	Verpakking	Code steel
135396	10	-
 5 410685 812860		

T-SPADESTEEL ANTWERPEN GEBOGEN 950/39





Art. Nr.	Verpakking	Code steel
139285	10	-
 5 410685 100103		

D-STEEL



D-SPADESTEEL 850/41 ES



Art. Nr.	Verpakking	Code steel
132285	5	-
 5 410685 100158		

D-SPADESTEEL 900/41 ES



Art. Nr.	Verpakking	Code steel
132390	5	-
 5 410685 100165		

BOLSTEEL

BOLSTEEL RECHT 1000/41 ES



Art. Nr.	Verpakking	Code steel
133305	10	-

BOLSTEEL RECHT 1000/36 RECHT CONISCH



Art. Nr.	Verpakking	Code steel
133305CB	2	-

BOLSTEEL GEBOGEN 1150/39 ES



Art. Nr.	Verpakking	Code steel
136305	10	-

BOLSTEEL GEBOGEN 1050/39





Art. Nr.	Verpakking	Code steel
136305CB	2	-

SCHOPSTELLEN

POLET TRADITIONAL

TRADITIONAL SCHOPSTEEL ES GEBOGEN





Art. Nr.	Verpakking	Code steel
PT141213A	1	-
 5 410685 872796		

FIBER 3001 STELEN



SCHOPSTEEL 1300/41 GEBOGEN FIBER 3001



Art. Nr.	Verpakking	Code steel
FH141213	5	-
 5 410685 855546		 

SCHOPSTEEL 1300/41 RECHT FIBER 3001





Art. Nr.	Verpakking	Code steel
FH141223	5	-
 5 410685 855829		 

SCHOPSTELLEN GEBOGEN / ES-BEUK



SCHOPSTEEL 1300/41 GEBOGEN A-KWALITEIT ES



Art. Nr.	Verpakking	Code steel
141213A	25	-
 5 410685 100219		



SCHOPSTEEL 1300/41 GEBOGEN ES



Art. Nr.	Verpakking	Code steel
141213	25	-
 5 410685 100202		

SCHOPSTEEL FSC 100% 1300/41 GEBOGEN ES



Art. Nr.	Verpakking	Code steel
141213S	25	-
 5 410685 869758		

SCHOPSTEEL 1300/41 GEBOGEN



Art. Nr.	Verpakking	Code steel
141213P	25	-

SCHOPSTEEL 1300/41 GEBOGEN BEUK



Art. Nr.	Verpakking	Code steel
142213	25	-

SCHOPSTELLEN RECHT / ES-BEUK

SCHOPSTEEL 1300/41 RECHT ES



Art. Nr.	Verpakking	Code steel
141223	10	-

SCHOPSTEEL 1300/41 RECHT BEUK



Art. Nr.	Verpakking	Code steel
142223	10	-

BATSSTELLEN

FIBER 3001 STELEN

BATSSTEEL T 950/38 FIBER 3001



Art. Nr.	Verpakking	Code steel
FH141611	5	-

BATSSTEEL T 1100/38 FIBER 3001





Art. Nr.	Verpakking	Code steel
FH1911002	5	-

BATSSTELEN HOUT



SCHOP/BATSSTEEL 950/41 STERKGEBOGEN ES



Art. Nr.	Verpakking	Code steel
141612	10	-
 5 410685 100288		



SCHOP/BATSSTEEL 950/41 LICHTGEBOGEN



Art. Nr.	Verpakking	Code steel
141621	10	-
 5 410685 100295		



SCHOP/BATSSTEEL 1000/41 LICHTGEBOGEN ES



Art. Nr.	Verpakking	Code steel
141611	10	-
 5 410685 100271		



SCHOP/BATSSTEEL 1100/41 LICHTGEBOGEN ES



Art. Nr.	Verpakking	Code steel
1911002	10	-
 5 410685 101438		



SCHOP/BATSSTEEL 1100/41 STERKGEBOGEN ES



Art. Nr.	Verpakking	Code steel
1911003	10	-
 5 410685 101445		

SCHOP/BATSSTEEL 1100/41 LICHTGEBOGEN



Art. Nr.	Verpakking	Code steel
1911022	10	-
 5 410685 809679		

TELESCOPISCHE STEEL

TELESCOPISCHE STEEL 2X70CM Ø22/28



Art. Nr.	Verpakking	Code steel
143700AL	1	-

RIEK-EN VORKSTELEN

RIEKSTELLEN MET VEERBUS

RIEKSTEEL D 850/39 VEERBUS



Art. Nr.	Verpakking	Code steel
141449K	5	-

RIEKSTEEL T 850/39 VEERBUS GEBOGEN



Art. Nr.	Verpakking	Code steel
141499	5	-

RIEKSTEEL 1350/36 VEERBUS GEBOGEN



Art. Nr.	Verpakking	Code steel
142412	5	-

RIEKSTEEL 1350/41 VEERBUS KUNSTSTOFRIEK





Art. Nr.	Verpakking	Code steel
143666	5	-

VORKSTELEN



VORKSTEEL 1350/36 RECHT ES



Art. Nr.	Verpakking	Code steel
141453	5	-
 5 410685 100394		



VORKSTEEL 1500/36 RECHT ES



Art. Nr.	Verpakking	Code steel
141455	5	-
 5 410685 100400		



VORKSTEEL 1650/36 ES



Art. Nr.	Verpakking	Code steel
141456	5	-
 5 410685 100417		



VORKSTEEL 1350/36 VEERBUS



Art. Nr.	Verpakking	Code steel
141453K	1	-
 5 410685 809594		



VORKSTEEL 1500/36 VEERBUS



Art. Nr.	Verpakking	Code steel
141455K	1	-
 5 410685 809600		

VORKSTEEL 1650/36 VEERBUS



Art. Nr.	Verpakking	Code steel
141456K	1	-
 5 410685 809617		

RIEKSTELEN MET D-GREEP

RIEKSTEEEL GEBOGEN 950/41 IJZER D-HANDVAT



Art. Nr.	Verpakking	Code steel
141449	5	-

RIEKSTEEEL RECHT 950/41 KUNSTSTOF D-HANDVAT



Art. Nr.	Verpakking	Code steel
141450	5	-

RIJF- EN HARKSTELEN

TRADITIONAL HAK/RAAKSTEEEL 1500/28 ES



Art. Nr.	Verpakking	Code steel
PT143650	1	-

RAAKSTEEEL 1500/28 FIBER 3001



Art. Nr.	Verpakking	Code steel
FH143650	5	-

RAAKSTEEEL 1300/28 KONUS





Art. Nr.	Verpakking	Code steel
143630	25	-

RAAKSTEEEL ES FSC 100% 1300/28 KONUS WAX





Art. Nr.	Verpakking	Code steel
143630S	1	-



RAAKSTEEL 1400/28 KONUS

Art. Nr.	Verpakking	Code steel
143640	25	-
 5 410685 100516		



RAAKSTEEL 1500/28 KONUS

Art. Nr.	Verpakking	Code steel
143650	25	-
 5 410685 100523		



RAAKSTEEL ES FSC 100% 1500/28 KONUS WAX

Art. Nr.	Verpakking	Code steel
143650S	1	-
 5 410685 868294		



RAAKSTEEL 1600/28 KONUS

Art. Nr.	Verpakking	Code steel
143660	25	-
 5 410685 100530		

RAAKSTEEL 1500/28 KONUS VERNIST

Art. Nr.	Verpakking	Code steel
143662	25	-
 5 410685 805565		

BEZEMSTEEL 1500/28 ES VERNIST

Art. Nr.	Verpakking	Code steel
143663	25	-
 5 410685 805572		

RAAKSTEEL 1700/28 KONUS



Art. Nr.	Verpakking	Code steel
143670	25	-

RAAKSTEEL ES FSC 100% 1700/28 KONUS WAX



Art. Nr.	Verpakking	Code steel
143670S	1	-

RAAKSTEEL 2500/28 ES



Art. Nr.	Verpakking	Code steel
141462	10	-

SCHOFFELSTELEN MET HILT

TRADITIONAL SCHOFFELSTEEL 1500/30 MET HILT



Art. Nr.	Verpakking	Code steel
PT1925016	1	-

SCHOFFELSTEEL 1600/29 MET HILT



Art. Nr.	Verpakking	Code steel
1925016	10	-

SCHOFFELSTEEL 1600/33 DOORGEWERKTE HILT





Art. Nr.	Verpakking	Code steel
1925096	10	-

BORSTEL-EN BEZEMSTELEN



BEZEMSTEEL 1500/28 FIBER 3001



Art. Nr.	Verpakking	Code steel
FH143652	5	-
 5 410685 855768		 



BORSTELSTEEL 1200/24



Art. Nr.	Verpakking	Code steel
143720	25	-
 5 410685 101285		



BORSTELSTEEL 1400/24



Art. Nr.	Verpakking	Code steel
143740	25	-
 5 410685 800928		

BORSTELSTEEL 1400/24





Art. Nr.	Verpakking	Code steel
143740Z	5	-
 5 410685 880869		

LANDHAK-EN TUINHAKSTELEN



TRADITIONAL LANDHAKSTEEL 1500/40



Art. Nr.	Verpakking	Code steel
PT142540	1	-
 5 410685 871225		

TUINHAKSTEEL 1300/34 ES



Art. Nr.	Verpakking	Code steel
142543	10	-
 5 410685 100332		

LANDHAKSTEEL 1400/41 ES



Art. Nr.	Verpakking	Code steel
142541	10	-

LANDHAKSTEEL 1500/41 ES



Art. Nr.	Verpakking	Code steel
142542	10	-

LANDHAKSTEEL 1500/40 BEUK



Art. Nr.	Verpakking	Code steel
142540	10	-

GARDENING 4 KIDS STELEN

G4K T-SPADESTEEL BEUK 850/35 RECHT



Art. Nr.	Verpakking	Code steel
136285	5	-

G4K T-SCHOPSTEEL BEUK 800/30 GEBOGEN



Art. Nr.	Verpakking	Code steel
131380	5	-



G4K RAAKSTEEL 1100/24 VERNIST



Art. Nr.	Verpakking	Code steel
143610	5	-

G4K BORSTELSTEEL 1100/24 VERNIST





Art. Nr.	Verpakking	Code steel
143710	5	-
 5 410685 881521		

BIJSTELLEN



TRADITIONAL HANDBIJLSTEEL GEBOGEN 400MM



Art. Nr.	Verpakking	Code steel
PT141310	1	-
 5 410685 880845		



HANDBIJLSTEEL 380/23/50



Art. Nr.	Verpakking	Code steel
141310	5	-
 5 410685 100653		



HOUW-EN KAPMESHECHT 150/28



Art. Nr.	Verpakking	Code steel
141320	5	-
 5 410685 100660		



BIJLSTEEL GEBOGEN 800/29/65 ES



Art. Nr.	Verpakking	Code steel
141390	5	-
 5 410685 100592		

BIJLSTEEL GEBOGEN 900/29/64 ES



Art. Nr.	Verpakking	Code steel
141392	5	-
 5 410685 100608		

HAMERSTELEN

TRADITIONAL KLIEFHAMERSTEEL 1M



Art. Nr.	Verpakking	Code steel
PT141995	1	-
 5 410685 872802		

KLIEF-EN VOORHAMERSTEEL 900/50/30 ES



Art. Nr.	Verpakking	Code steel
141990	10	-
 5 410685 100677		

KLIEF-EN VOORHAMERSTEEL 900/50/30 ES FSC 100%



Art. Nr.	Verpakking	Code steel
141990S	10	-
 5 410685 869734		

KLIEF-EN VOORHAMERSTEEL 900/50/30 HICKORY



Hickory
Wood

Art. Nr.	Verpakking	Code steel
141995	10	-
 5 410685 100691		

VOORHAMERSTEEL 900/38/24 ES





Art. Nr.	Verpakking	Code steel
141991	10	-
 5 410685 100707		

POLET TRADITIONAL KASSEIHAMERSTEEL

TRADITIONAL KASSEIHAMERSTEEL





Art. Nr.	Verpakking	Code steel
PT151099	1	-
 5 410685 873168		

HANDHAMERSTELLEN ES



STEEL VOOR STRATENMAKERSHAMER 210/32 ROND



Art. Nr.	Verpakking	Code steel
151099	5	-
 5 410685 102039		

MOKERSTEEL 280/29/18 ES





Art. Nr.	Verpakking	Code steel
151102	10	-
 5 410685 100813		

MOKERSTEEL 300/30/21 HICKORY





Hickory
Wood

Art. Nr.	Verpakking	Code steel
151103H	10	-
 5 410685 101681		



MOKERSTEEL 300/30/21 ES



Art. Nr.	Verpakking	Code steel
151103	10	-
 5 410685 100820		

HAMERSTEEL 280/18/10 ES



Art. Nr.	Verpakking	Code steel
151128	10	-
 5 410685 100738		

HAMERSTEEL 300/21/12 ES



Art. Nr.	Verpakking	Code steel
151130	10	-

HAMERSTEEL 320/26/15 ES



Art. Nr.	Verpakking	Code steel
151132	10	-

HAMERSTEEL 350/29/17 ES



Art. Nr.	Verpakking	Code steel
151135	10	-

HAMERSTEEL 380/33/20 ES



Art. Nr.	Verpakking	Code steel
151138	10	-

HAMERSTEEL 400/37/22 ES



Art. Nr.	Verpakking	Code steel
151140	10	-

HAMERSTEEL 450/37/22 ES



Art. Nr.	Verpakking	Code steel
151145	10	-

DALHAMERBLOKKEN

TRADITIONAL DALHAMERBLOK-METALEN RING



Art. Nr.	Verpakking	Code steel
PT151500	1	-
 5 410685 873878		

TRADITIONAL DALHAMERSTEEL 180CM



Art. Nr.	Verpakking	Code steel
PT132180	1	-
 5 410685 886175		

DALHAMERBLOK 195/90/55 ES



Art. Nr.	Verpakking	Code steel
151500	1	-
 5 410685 100882		

TUINHAMERSTELN

STEEL VOOR TUINHAMER ROND 985X39 ES



Art. Nr.	Verpakking	Code steel
151005	1	-
 5 410685 100912		

STEEL ES VOOR KUNSTSTOF TUINHAMER



Art. Nr.	Verpakking	Code steel
151006	1	-
 5 410685 806524		

STEEL ES VOOR TUINHAMER OVAAL 100CM 55X35





Art. Nr.	Verpakking	Code steel
151007	1	-
 5 410685 867631		

PIKHOUWHEELSTELEN



TRADITIONAL BIJLHOUWHEELSTEEL ES 1.1M



Art. Nr.	Verpakking	Code steel
PT141311	1	-
 5 410685 871379		



PIKHOUWHEELSTEEL 900/50 ROND ES



Art. Nr.	Verpakking	Code steel
141890	10	-
 5 410685 100929		



PIKHOUWHEELSTEEL 900/55 ROND ES



Art. Nr.	Verpakking	Code steel
141893	10	-
 5 410685 100936		



PIKHOUWHEELSTEEL 950/70/44 OVAAL ES



Art. Nr.	Verpakking	Code steel
141894	10	-
 5 410685 100967		



PIKHOUWHEELSTEEL 950/64/39 OVAAL ES



Art. Nr.	Verpakking	Code steel
141895	10	-
 5 410685 100950		

STEEL BIJLHOUWHEEL 1050/55/35





Art. Nr.	Verpakking	Code steel
151502	5	-
 5 410685 199909		

STELLEN VOOR ALUMINIUM BETONSSCHUIVERS EN INDUSTRIELE VLOERWISSERS



RECHTE STEEL 1700X30MM ES



Art. Nr.	Verpakking	Code steel
141461	5	-
 5 410685 805558		

RECHTE STEEL 1700X32MM ES VERNIST





Art. Nr.	Verpakking	Code steel
141460	5	-
 5 410685 805442		

KLEINE STELEN

TRUWHEELHECHTEN

TRUWHEELHECHT 135/24/33





Art. Nr.	Verpakking	Code steel
151315	10	-
 5 410685 100974		

VIJLHECHTEN



VIJLHECHT 100MM



Art. Nr.	Verpakking	Code steel
151410	10	-
 5 410685 101018		



VIJLHECHT 120MM



Art. Nr.	Verpakking	Code steel
151412	10	-
 5 410685 101025		

VIJLHECHT 140MM









Art. Nr.	Verpakking	Code steel
151414	10	-
 5 410685 101032		

TOEBEHOREN

SPIEEN VOOR INSTELLEN





SPIE VOOR INSTELLEN (DOOS MET 25 ST.)



Product	Art. Nr.	Verpakking	Code steel	
NR 1	151201	1	-	 5410685101063
NR 2	151202	1	-	 5410685101070
NR 3	151203	1	-	 5410685101087
NR 4	151204	1	-	 5410685101094
NR 4AH	151244	1	-	 5410685101100
NR 5	151205	1	-	 5410685101117





SPIE OP KAART SET 1,2,3



Art. Nr.	Verpakking	Code steel
151208	5	-
 5 410685 101124	  	

SPIE OP KAART SET 4,4AH,5



Art. Nr.	Verpakking	Code steel
151209	5	-
 5 410685 101131	  	

TOEBEHOREN VOOR SPADES

2 VOETSTEUNEN VOOR SPADES (SKINPACK)



Art. Nr.	Verpakking	Code steel
100001	5	-

KLINKNAGELS SPADE 5X50MM (25 ST./DOOS)

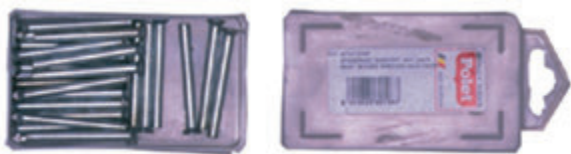

Art. Nr.	Verpakking	Code steel
8700123D	1	-

KLINKNAGELS SPADE 5X50MM (3 ST./SKINPACK)



Art. Nr.	Verpakking	Code steel
8700123SP	5	-

KUNSTSTOFHANDGREPEN

KUNSTSTOF D-GREEP



Art. Nr.	Verpakking	Code steel
151210	5	-

KUNSTSTOF T-GREEP



Art. Nr.	Verpakking	Code steel
151211	1	-

KUNSTSTOF D-GREEP VOOR SNEEUWSCHOP



Art. Nr.	Verpakking	Code steel
151212	1	-

ALL-FIX

ALL-FIX HOUDER BULK (20 ST.=1 BOX)



Art. Nr.	Verpakking	Code steel
370000	20	-

ALL-FIX-1 GEREEDSCHAPHOUDER



Art. Nr.	Verpakking	Code steel
370010	20	-

ALL-FIX-3 3 HOUDERS+RAIL 500MM



Art. Nr.	Verpakking	Code steel
370020	10	-

ALL-FIX-5 5 HOUDERS+RAIL 900MM



Art. Nr.	Verpakking	Code steel
370030	10	-

A man in a bright green t-shirt and dark shorts is pushing a black metal hose reel cart. The cart has a large yellow hose coiled on it and four wheels. He is in a greenhouse with rows of colorful flowers in pots. The background shows the structure of the greenhouse with hanging wires.

Polet

AQUALITY

De Latijnse benaming voor water is AQUA. Polet staat garant voor KWALITEIT. De som van beide woorden maakt AQUALITY: onze waterreeks met kwalitatieve sproeipistolen, koppelingen en kraanstukken, in kunststof of messing.

Ook slangenwagens en tuinslangen zitten in ons assortiment, voor zowel de hobbytuinier als de professional.

SLANGENHASPELS

PROFESSIELE SLANGENHASPELS

PROF. SLANGENWAGEN 4W CAP. 3/4" | 19MM - 130M



CAPACITEIT MET
ANDERE SLANGEN:
1/2" | 13MM - 260M
5/8" | 15MM - 200M

Art. Nr.	Verpakking	Code steel
734130	1	-
54106858233		

AFMETING
NA MONTAGE:

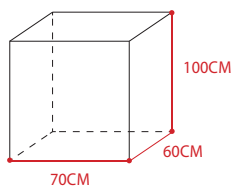

PROF. SLANGENWAGEN 2W FF CAP. 3/4" | 19MM - 90M

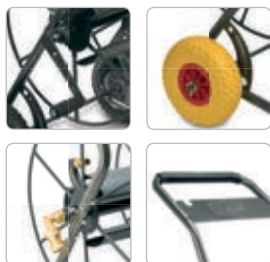

CAPACITEIT MET
ANDERE SLANGEN:
1/2" | 13MM - 180M
5/8" | 15MM - 150M

Art. Nr.	Verpakking	Code steel
730130FF	1	-
54106858226		

AFMETING
NA MONTAGE:

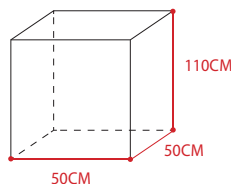

PROF. SLANGENWAGEN 2W CAP. 3/4" | 19MM - 90M



CAPACITEIT MET
ANDERE SLANGEN:
1/2" | 13MM - 180M
5/8" | 15MM - 150M

Art. Nr.	Verpakking	Code steel
730130	1	-
5410685856390		

AFMETING
NA MONTAGE:

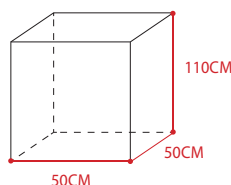

PROF. SLANGENWAGEN 2W CAP. 1/2" | 13MM - 140M



BRASS CONNECTOR
 CAPACITEIT MET ANDERE SLANGEN:
 5/8" | 15MM - 110M
 3/4" | 19MM - 70M

Art. Nr.	Verpakking	Code steel
730095	1	-

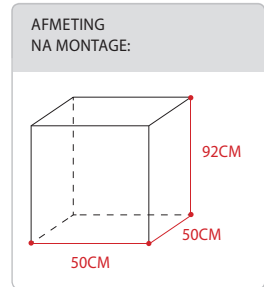

PROF. SLANGENWAGEN 2W CAP. 1/2" | 13MM - 105M



BRASS CONNECTOR
 CAPACITEIT MET ANDERE SLANGEN:
 5/8" | 15MM - 80M
 3/4" | 19MM - 50M

Art. Nr.	Verpakking	Code steel
730050	1	-

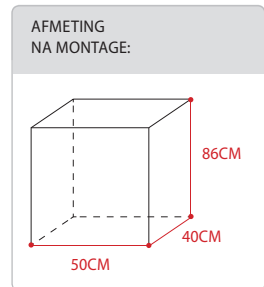

SLANGENHASPELS

SLANGENWAGEN 2W CAP. 1/2" | 13MM - 80M



BRASS CONNECTOR
 CAPACITEIT MET ANDERE SLANGEN:
 5/8" | 15MM - 60M
 3/4" | 19MM - 40M

Art. Nr.	Verpakking	Code steel
735050	1	-
5410685857168		

AFMETING
NA MONTAGE:

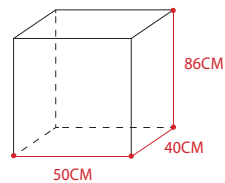

BREEDTE
TROMMEL:



SLANGENWAGEN 2W CAP. 1/2" | 13MM - 60M

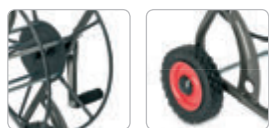

BRASS CONNECTOR
 CAPACITEIT MET ANDERE SLANGEN:
 5/8" | 15MM - 45M
 3/4" | 19MM - 30M

Art. Nr.	Verpakking	Code steel
735025	1	-
5410685857151		

AFMETING
NA MONTAGE:

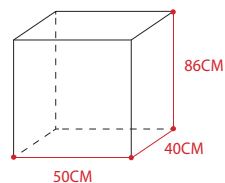

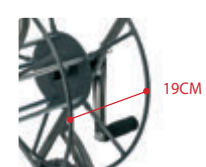

BREEDTE
TROMMEL:



SLANGENHASPEL+20M 1/2" (13MM) SLANG



Art. Nr.	Verpakking	Code steel
741160	1	-
		 
5 410685 862797		

SLANGENHASPEL



- licht & universeel, complete set
- gebruiksklaar
- uitschuifbare greep = plaatsbesparend en ergonomisch
- handige slanggeleider
- aluminium frame



VERVANGSTUKKEN EN ACCESSOIRES SLANGENHASPELS



KOPPELSTUK 1/2" (13MM) VOOR SLANGENWAGEN BLISTER



Art. Nr.	Verpakking	Code steel
736102	1	-
		 
5 410685 860816		



KOPPELSTUK 3/4" (19MM) VOOR SLANGENWAGEN BLISTER



Art. Nr.	Verpakking	Code steel
736103	1	-
		 
5 410685 860823		



WIEL SLANGENWAGEN PU



Art. Nr.	Verpakking	Code steel
KW555021	1	-
		 
5 410685 867556		

MUURSLANGENHOUDER CAP. 30M TUINSLANG



Art. Nr.	Verpakking	Code steel
741225	6	-
		 
5 410685 862810		

SET 1,5M SLANG 1/2"+KRAANSTUK+2 KOPPELSTUKKEN



Art. Nr.	Verpakking	Code steel
741315	6	-

TUINSLANGEN AQUALITY

TUINSLANGEN

GOOD AQUALITY



BUILDING EXPERT AQUALITY



PRO AQUALITY



Ø	20 BAR	25 BAR	+50°C -10°C	+60°C -20°C	ALL SEASON	UV PROTECTION	X LIFE	ANTI ALGAE	ANTI TWIST
1/2" → 13mm 5/8" → 15mm	✓		✓		✓	✓	✓	✓	
1/2" → 13mm 5/8" → 15mm 3/4" → 19mm 1" → 25mm		✓		✓	✓	✓	✓	✓	
1/2" → 13mm 5/8" → 15mm 3/4" → 19mm		✓		✓	✓	✓	✓	✓	✓

TUINSLANGEN GOOD AQUALITY

TUINSLANG



Afmeting	Art. Nr.	Verpakking	Code steel	
1/2"-13MM 25M	7371125	1	-	
1/2"-13MM 50M	7371150	1	-	
5/8"-15MM 25M	7371225	1	-	
5/8"-15MM 50M	7371250	1	-	

TUINSLANGEN BUILDING EXPERT AQUALITY

TUINSLANG BUILDING EXPERT



Afmeting	Art. Nr.	Verpakking	Code steel	
1/2"-13MM 25M	7372125	1	-	 5410685861035
1/2"-13MM 50M	7372150	1	-	 5410685861073
5/8"-15MM 25M	7372225	1	-	 5410685861042
5/8"-15MM 50M	7372250	1	-	 5410685861080
3/4"-19MM 25M	7372325	1	-	 5410685861059
3/4"-19MM 50M	7372350	1	-	 5410685861097
1"-25MM 25M	7372425	1	-	 5410685861066
1"-25MM 50M	7372450	1	-	 5410685861103

TUINSLANGEN PRO AQUALITY

TUINSLANG PRO AQUALITY



Afmeting	Art. Nr.	Verpakking	Code steel	
1/2"-13MM 25M	7374125	1	-	 5410685861158
1/2"-13MM 50M	7374150	1	-	 5410685861196
5/8"-15MM 25M	7374225	1	-	 5410685861165
5/8"-15MM 50M	7374250	1	-	 5410685861202
3/4"-19MM 25M	7374325	1	-	 5410685861172
3/4"-19MM 50M	7374350	1	-	 5410685861219

SLANGENGELEIDER

SLANGENGELEIDER



Art. Nr.	Verpakking	Code steel
7370001	1	-

SPROEIMATERIAAL

KLAUWKOPPELINGEN EN ONDERDELEN

KLAUWKOPPELING 1/2"-13MM SLANG KORT MESSING



Art. Nr.	Verpakking	Code steel
KK100012	1	-

KLAUWKOPPELING 5/8"-15MM SLANG KORT MESSING



Art. Nr.	Verpakking	Code steel
KK100058	1	-

KLAUWKOPPELING 3/4"-19MM SLANG KORT MESSING



Art. Nr.	Verpakking	Code steel
KK100034	1	-

KLAUWKOPPELING 1"-25MM SLANG KORT MESSING



Art. Nr.	Verpakking	Code steel
KK100100	1	-





KLAUWKOPPELING 1 1/2"-38MM SLANG KORT MESSING



Art. Nr.	Verpakking	Code steel
KK100112	1	-





KLAUWKOPPELING 1 1/4"-29MM SLANG KORT MESSING



Art. Nr.	Verpakking	Code steel
KK100114	1	-
 5 410685 877388		   





KLAUWKOPPELING G3/4"-26,5MM BUITENDRAAD MESSING



Art. Nr.	Verpakking	Code steel
KK200034	1	-
 5 410685 877449		   

KLAUWKOPPELING G1"-33MM BUITENDRAAD MESSING





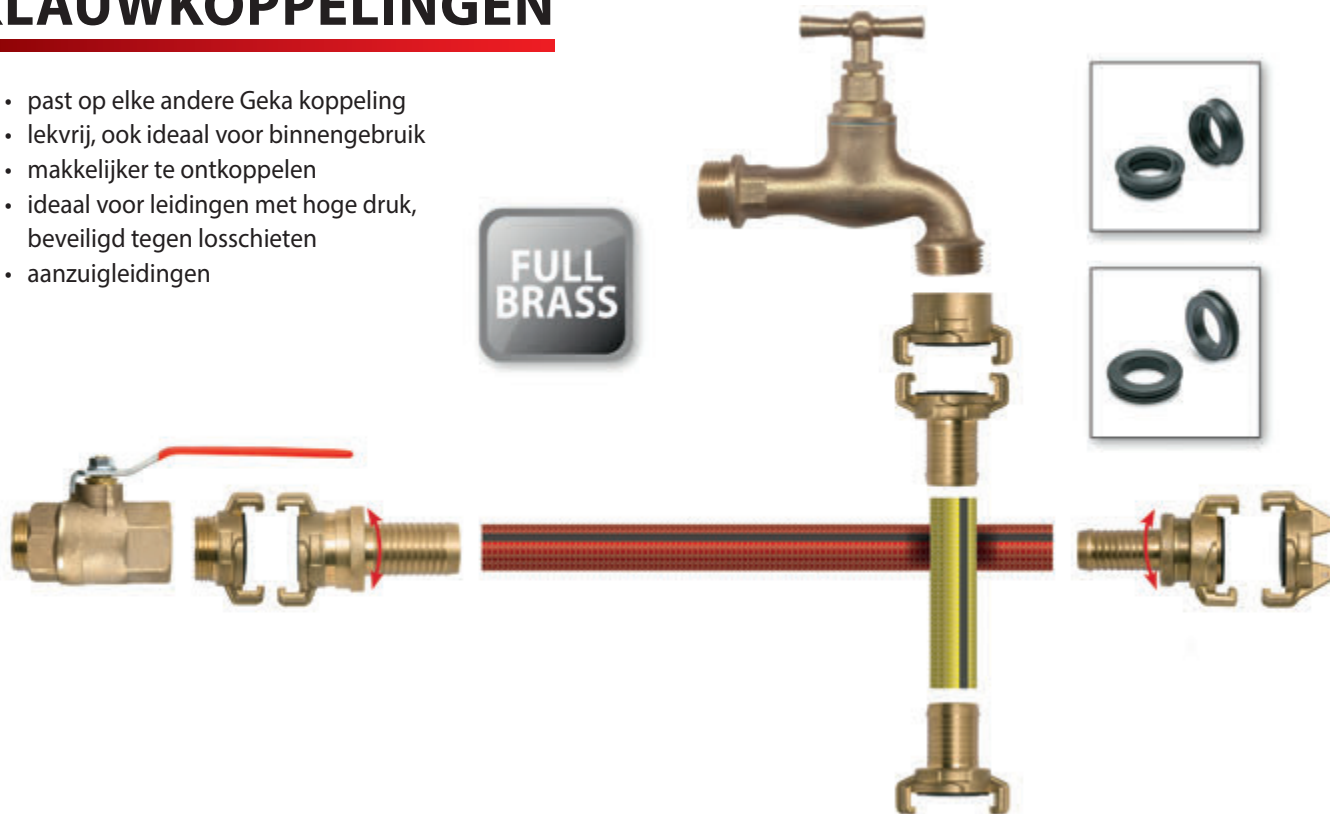

Art. Nr.	Verpakking	Code steel
KK200100	1	-
 5 410685 877456		   

KLAUWKOPPELINGEN





- past op elke andere Geka koppeling
- lekvrij, ook ideaal voor binnengebruik
- makkelijker te ontkoppelen
- ideaal voor leidingen met hoge druk, beveiligd tegen losschieten
- aanzuigleidingen







KLAUWKOPPELING G1 1/4"-42MM BUITENDRAAD MESSING

Art. Nr.	Verpakking	Code steel
KK200114	1	-
 5 410685 877463		   





KLAUWKOPPELING 3/4"-25MM BINNENDRAAD MESSING

Art. Nr.	Verpakking	Code steel
KK300034	1	-
 5 410685 877470		   





KLAUWKOPPELING G1"-31MM BINNENDRAAD MESSING

Art. Nr.	Verpakking	Code steel
KK300100	1	-
 5 410685 877487		   





KLAUWKOPPELING G1 1/4"-40MM BINNENDRAAD MESSING

Art. Nr.	Verpakking	Code steel
KK300114	1	-
 5 410685 877494		   

KLAUWKOPPELING 3/4"-19MM SPROEILANS MESSING







Art. Nr.	Verpakking	Code steel
KK400034	1	-
 5 410685 877562		   

KLAUWK 1/2"-13MM SLANG VERSTELBAAR MESSING

Art. Nr.	Verpakking	Code steel
KK500012	1	-
 5 410685 877531		   





KLAUWK 3/4"-19MM SLANG VERSTELBAAR MESSING



Art. Nr.	Verpakking	Code steel
KK500034	1	-
 5 410685 877548		   





KLAUWKOPPELING 5/8"-15MM SLANG VERSTELBAAR MESSING



Art. Nr.	Verpakking	Code steel
KK500058	1	-
 5 410685 877524		   





KLAUWKOPPELING 1"-25MM SLANG VERSTELBAAR MESSING



Art. Nr.	Verpakking	Code steel
KK500100	1	-
 5 410685 877555		   





KLAUWKOPPELING EINDSTOP



Art. Nr.	Verpakking	Code steel
KK600000	1	-
 5 410685 877517		   





KLAUWKOPPELING VERVANGRUBBER VOOR KK1-2-3-4-6



Art. Nr.	Verpakking	Code steel
KK600010	1	-
 5 410685 877586		   

KLAUWKOPPELING VERVANGRUBBER VOOR KK5



Art. Nr.	Verpakking	Code steel
KK600020	1	-
 5 410685 877593		   

SPANRING



Afmeting	Art. Nr.	Verpakking	Code steel	
1/4"-1/2" 8MM-13MM	KK610813	1	-	 5410685878712
1/2"-3/4" 13MM-26MM	KK611326	1	-	 5410685878729
5/8"-1" 16MM-32MM	KK611632	1	-	 5410685878736
3/4"-1 1/4" 21MM-38MM	KK612138	1	-	 5410685878743
1 1/4"-1 1/2" 29MM-47MM	KK612947	1	-	 5410685878750
1 1/2"-2" 38MM-57MM	KK613857	1	-	 5410685878767
1 3/4"-2 1/4" 40MM-64MM	KK614064	1	-	 5410685878774

BRASS KOPPELINGEN EN ONDERDELEN

KRAANSTUK BRASS 1/2"(13MM) - 3/4"(19MM) SOFTTOUCH BLISTER



Art. Nr.	Verpakking	Code steel
744111	6	-
 5 410685 863145		

KRAANSTUK BRASS 1"(25MM) SOFTTOUCH BLISTER



Art. Nr.	Verpakking	Code steel
744121	6	-
 5 410685 863152		





KOPPELING BRASS 1/2"(13MM) - 5/8"(15MM) SOFTTOUCH BLISTER



Art. Nr.	Verpakking	Code steel
744311	6	-
 5 410685 863169		





KOPPELING BRASS 1/2"(13MM) - 5/8"(15MM) SOFTTOUCH AQUASTOP BLISTER



Art. Nr.	Verpakking	Code steel
744321	6	-
 5 410685 863176		  





KOPPELING BRASS 3/4"(19MM) SOFTTOUCH BLISTER



Art. Nr.	Verpakking	Code steel
744331	6	-
 5 410685 863183		  





KOPPELING BRASS 3/4"(19MM) SOFTTOUCH AQUASTOP BLISTER



Art. Nr.	Verpakking	Code steel
744341	6	-
 5 410685 863190		  





SPROEILANS BRASS REGELBAAR SOFTTOUCH BLISTER



Art. Nr.	Verpakking	Code steel
744511	6	-
 5 410685 863244		  





SPROEILANS BRASS REGELBAAR+SET SOFTTOUCH BLISTER



Art. Nr.	Verpakking	Code steel
744521	6	-
 5 410685 863251		  

HERSTELKOPPELING BRASS 1/2"(13MM) - 5/8"(15MM) BLISTER



Art. Nr.	Verpakking	Code steel
744411	6	-
 5 410685 863206		  

HERSTELKOPPELING BRASS 3/4"(19MM) BLISTER



Art. Nr.	Verpakking	Code steel
744421	6	-

DUBBELE KOPPELING BRASS BLISTER



Art. Nr.	Verpakking	Code steel
744431	6	-

DRIEWEGKOPPELING BRASS BLISTER



Art. Nr.	Verpakking	Code steel
744441	6	-

MAX FLOW: GROTE DOORSTROOMDIAMETER

KRAANSTUK 3/4"(19MM) MAX FLOW BLISTER



Art. Nr.	Verpakking	Code steel
742131	24	-

KRAANSTUK 1"(25MM) MAX FLOW BLISTER



Art. Nr.	Verpakking	Code steel
742141	24	-

KRAANSTUK 3/4"(19MM) - 1"(25MM) MAX FLOW BLISTER



Art. Nr.	Verpakking	Code steel
742151	24	-

KOPPELING 5/8"(15MM) - 3/4"(19MM) MAX FLOW BLISTER



Art. Nr.	Verpakking	Code steel
743251	14	-

KOPPELING 1"(25MM) MAX FLOW BLISTER



Art. Nr.	Verpakking	Code steel
743261	14	-

HERSTELKOPPELING 3/4"(19MM) - 1"(25MM) MAX FLOW BLISTER



Art. Nr.	Verpakking	Code steel
743481	14	-

HERSTELKOPPELING 1"(25MM) MAX FLOW BLISTER



Art. Nr.	Verpakking	Code steel
743491	14	-

SPROEIPISTOOL MAX FLOW



Art. Nr.	Verpakking	Code steel
744131	14	-

KRAANSTUKKEN-KOPPELINGEN EN ONDERDELEN



742121 3/4"-1" \varnothing 19-25 mm

742111 1/2"-3/4" \varnothing 13-19 mm

742211 3/4" \varnothing 19 mm

743471 3/4" \varnothing 19 mm

743221 3/4" \varnothing 19 mm

743211 1/2"-5/8" \varnothing 13-16 mm

ALL SEASON +60° C -20° C 25 BAR

UV PROTECTION ANTI ALGAE ANTI TWIST

3 LAYERS

ALL SEASON +60° C -20° C 25 BAR

UV PROTECTION ANTI ALGAE

743421 5/8"-3/4" \varnothing 16-19 mm

743241 3/4" \varnothing 19 mm

743431 CONNECT

743411 1/2"-5/8" \varnothing 13-16 mm

743231 1/2"-5/8" \varnothing 13-16 mm

743441 3 WAY

742321 3/4"-1" \varnothing 19-25 mm

745421 7 SPRAYS IN 1

745411 Brass Spray Nozzle

745111 2 SPRAYS IN 1

FULL METAL



BRASS PARTS

UNIVERSAL COMPATIBLE

SOFT GRIP



KRAANSTUK 1/2"(13MM) - 3/4"(19MM) BLISTER



Art. Nr.	Verpakking	Code steel
742111	6	-
 5 410685 862841		 



KRAANSTUK 1/2"(13MM) - 3/4"(19MM) BULK



Art. Nr.	Verpakking	Code steel
742112	50	-
 5 410685 862834		 



KRAANSTUK 3/4"(19MM) - 1"(25MM) BLISTER



Art. Nr.	Verpakking	Code steel
742121	6	-
 5 410685 862858		 



KRAANSTUK 3/4"(19MM) - 1"(25MM) BULK



Art. Nr.	Verpakking	Code steel
742122	50	-
 5 410685 862865		 



KRAANSTUK 3/4"(19MM) BLISTER



Art. Nr.	Verpakking	Code steel
742211	6	-
 5 410685 862889		 

KRAANSTUK 3/4"(19MM) BULK



Art. Nr.	Verpakking	Code steel
742212	25	-
 5 410685 862872		 

KRAANSTUK DUPLEX 3/4"(19MM) - 1"(25MM) BLISTER



Art. Nr.	Verpakking	Code steel
742321	6	-

KRAANSTUK 4 UITGANGEN 3/4"(19MM) - 1"(25MM) BLISTER



Art. Nr.	Verpakking	Code steel
742331	4	-

KOPPELING 1/2"(13MM) - 5/8"(15MM) BLISTER



Art. Nr.	Verpakking	Code steel
743211	6	-

KOPPELING 1/2"(13MM) - 5/8"(15MM) BULK



Art. Nr.	Verpakking	Code steel
743212	50	-

KOPPELING 3/4"(19MM) BLISTER



Art. Nr.	Verpakking	Code steel
743221	6	-

KOPPELING 3/4"(19MM) BULK



Art. Nr.	Verpakking	Code steel
743222	50	-

KOPPELING 1/2"(13MM) - 5/8"(15MM) AQUASTOP BLISTER



Art. Nr.	Verpakking	Code steel
743231	6	-

KOPPELING 1/2"(13MM) - 5/8"(15MM) AQUASTOP BULK



Art. Nr.	Verpakking	Code steel
743232	50	-

KOPPELING 3/4"(19MM) AQUASTOP BLISTER



Art. Nr.	Verpakking	Code steel
743241	6	-

KOPPELING 3/4"(19MM) AQUASTOP BULK



Art. Nr.	Verpakking	Code steel
743242	50	-

KOPPELING 1/2"(13MM) - 5/8"(15MM)BLISTER



Art. Nr.	Verpakking	Code steel
743311	6	-

KOPPELING 3/4"(19MM) BLISTER



Art. Nr.	Verpakking	Code steel
743321	6	-

KOPPELING 1/2"(13MM) - 5/8"(15MM) AQUASTOP BLISTER



Art. Nr.	Verpakking	Code steel
743331	6	-

KOPPELING 3/4"(19MM) AQUASTOP BLISTER



Art. Nr.	Verpakking	Code steel
743341	6	-

HERSTELKOPPELING 1/2"(13MM) - 5/8"(15MM) BLISTER



Art. Nr.	Verpakking	Code steel
743411	6	-

HERSTELKOPPELING 1/2"(13MM) - 5/8"(15MM) BULK



Art. Nr.	Verpakking	Code steel
743412	50	-

HERSTELKOPPELING 5/8"(15MM) - 3/4"(19MM) BLISTER



Art. Nr.	Verpakking	Code steel
743421	6	-



HERSTELKOPPELING 5/8"(15MM) - 3/4"(19MM) BULK



Art. Nr.	Verpakking	Code steel
743422	50	-



DUBBELE KOPPELING BLISTER



Art. Nr.	Verpakking	Code steel
743431	6	-
 5 410685 863077		 



DUBBELE KOPPELING BULK



Art. Nr.	Verpakking	Code steel
743432	25	-
 5 410685 863084		 



DRIEWEGKOPPELING BLISTER



Art. Nr.	Verpakking	Code steel
743441	6	-
 5 410685 863091		 



DRIEWEGKOPPELING BULK



Art. Nr.	Verpakking	Code steel
743442	25	-
 5 410685 863107		 



AANSLUITSTUK BUITENDRAAD 3/4"(19MM) BLISTER



Art. Nr.	Verpakking	Code steel
743471	6	-
 5 410685 863138		 



SET RONDE DICHTINGEN BLISTER



Art. Nr.	Verpakking	Code steel
743451	6	-
 5 410685 863114		 

SET PLATTE DICHTINGEN EN FILTERS BLISTER





Art. Nr.	Verpakking	Code steel
743461	6	-
		

PISTOLEN EN SPROEILANSEN



SPROEILANS REGELBAAR BLISTER



Art. Nr.	Verpakking	Code steel
745111	6	-
		



SPROEILANS REGELBAAR + SET BLISTER



Art. Nr.	Verpakking	Code steel
745121	6	-
		



SPROEIPISTOOL MINI REGELBAAR BLISTER



Art. Nr.	Verpakking	Code steel
745131	6	-
		



SPROEIPISTOOL VERSTELBAAR BLISTER



Art. Nr.	Verpakking	Code steel
745231	12	-
		

SPROEIPISTOOL REGELBAAR BLISTER



Art. Nr.	Verpakking	Code steel
745241	12	-
		

SPROEIPISTOOL REGELBAAR BLISTER



Art. Nr.	Verpakking	Code steel
745311	6	-
 5 410685 863275		

SPROEIPISTOOL METAAL REGELBAAR BLISTER



Art. Nr.	Verpakking	Code steel
745411	6	-
 5 410685 863312		

SPROEIPISTOOL METAAL VERSTELBAAR BLISTER



Art. Nr.	Verpakking	Code steel
745421	6	-
 5 410685 863329		

SPROEIERS

SPROEIER RONDDRAAIEND+STATISCH METALEN PIN



Art. Nr.	Verpakking	Code steel
746111	3	-
 5 410685 863350		

SPROEIER RONDDRAAIEND 6 PATROON AANDRIJVING



Art. Nr.	Verpakking	Code steel
746112	1	-
 5 410685 891032		

SPROEIER RONDDRAAIEND METALEN VOETSTUK



Art. Nr.	Verpakking	Code steel
746122	3	-
 5 410685 863343		

ZWENKSPROEIER 16 SPROEIKOPPEN SOFT FACE

Art. Nr.	Verpakking	Code steel
746132	6	-

ZWENKSPROEIER 16 SPROEIKOPPEN COMPACT

Art. Nr.	Verpakking	Code steel
746133	1	-

ZWENKSPROEIER REGELBAAR 18 RUBBER SPROEIKOPPEN

Art. Nr.	Verpakking	Code steel
746143	1	-

TURBO MINI OSCILLATOR MET TIMER POLYPROPYLEEN VOET

Art. Nr.	Verpakking	Code steel
746114	1	-

SPROEIER RONDRAAIEND 4 PATROON AANDRIJVING MET MESSING KOPPELING

Art. Nr.	Verpakking	Code steel
746113	1	-

DRUKSPROEIERS



EPDM dichting

RODE DICHTING

Voor spuitmiddelen*:

Vuurvaste hydraulische vloeistoffen
Alcoholen
Ketonen
Water (>80°C)
Verdunde zuren
Alkaliën
Pesticiden

VITON dichting





GROENE DICHTING

Voor spuitmiddelen*:

Smeer- en brandstofoliën
Hydraulische oliën
Plantaardige oliën, dierlijke vetten
Benzine (hoog octaangehalte)
Kerosine
Aromatische koolwaterstoffen
Alifatische koolwaterstoffen
Alcoholen
Gehalogeneerde oplosmiddelen
Water (>80°C)
Geconcentreerde zuren
Verdunde zuren
Pesticiden





DRUKSPROEIER 2L EPDM DICHTINGEN



Art. Nr.	Verpakking	Code steel
747332	1	-
		  
5410685873489		

DRUKSPROEIER 2L EPDM DICHTINGEN



Art. Nr.	Verpakking	Code steel
747302	1	-
		  
5410685873496		

DRUKSPROEIER 5L EPDM DICHTINGEN



Regelbare sproeier



Overdrukventiel







Regelbaar handvat



Grote vulopening



3D Handvat

Art. Nr.	Verpakking	Code steel
747335	1	-
		  
5410685873519		

DRUKSPROEIER 8L EPDM DICHTINGEN



Regelbare sproeier



Overdrukventiel



Regelbaar handvat



Grote vulopening



Handvat

Art. Nr.	Verpakking	Code steel
747308	1	-
 5410685873540		

DRUKSPROEIER 5L EPDM DICHTINGEN



Regelbare sproeier



Blootstellingvrij overdrukventiel



Drukmeter



Grote vulopening



Handvat

Art. Nr.	Verpakking	Code steel
747305	1	-
 5410685873526		

DRUKSPROEIER 12L EPDM DICHTINGEN



Regelbare sproeier



Verstelbare sproeierstang



Groot volume pomp







Grote vulopening

Art. Nr.	Verpakking	Code steel
747312	1	-
 5410685873557		

DRUKSPROEIER 2L VITON DICHTINGEN



Art. Nr.	Verpakking	Code steel
747402	1	-
 5410685873502		  

DRUKSPROEIER 5L VITON DICHTINGEN



Regelbare sproeier



Blootstellingvrij overdrukventiel







Drukmeter



Grote vulopening



Handvat

Art. Nr.	Verpakking	Code steel
747405	1	-
 5410685873533		  

DRUKSPROEIER 12L VITON DICHTINGEN



Regelbare sproeier

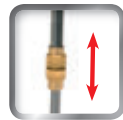





Verstelbare sproeierstang



Groot volume pomp



Grote vulopening

Art. Nr.	Verpakking	Code steel
747412	1	-
 5410685873564		  

GIETERS EN EMMERS GEGALVANISEERD

GIETERS EN EMMERS 0,45MM GEGALVANISEERD

GIETER 2L GEGALVANISEERD-0,45MM



Art. Nr.	Verpakking	Code steel
790102	3	-

GIETER 3L GEGALVANISEERD-0,45MM



Art. Nr.	Verpakking	Code steel
790103	6	-

GIETER 6L GEGALVANISEERD-0,45MM



Art. Nr.	Verpakking	Code steel
790106	6	-

GIETER 10L GEGALVANISEERD-0,45MM



Art. Nr.	Verpakking	Code steel
790110	6	-

EMMER 10L GEGALVANISEERD-0,45MM



Art. Nr.	Verpakking	Code steel
790410	3	-





EMMER 14L GEGALVANISEERD-0,45MM



Art. Nr.	Verpakking	Code steel
790414	3	-

GIETERS 0,7MM GEGALVANISEERD
GIETER 13L VOOR TEER/ASFALT UITGANG 27MM



Art. Nr.	Verpakking	Code steel
790313	3	-
 5 410685 891087		  



MERCHANDISING

In samenspraak met ons sales team kunnen wij voor u een presentatie uitwerken, aangepast aan uw winkel. Audiovisuele ondersteuning door een videoscherm behoort ook tot de mogelijkheden. Wij hebben een aantal displays ontworpen waarmee u op een beperkte ruimte goed roterende producten kunt voorstellen. Daarnaast bestaat de mogelijkheid om sets samen te stellen voor seizoensgebonden promo-acties. Ons sales team staat u hiervoor graag met raad en daad bij.

SETS



DISPLAYS



VIDEOSCHERM

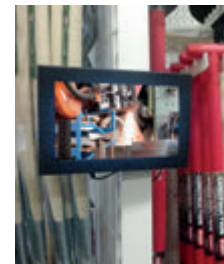

VOLLEDIGE WINKELCONCEPTEN OP UW MAAT

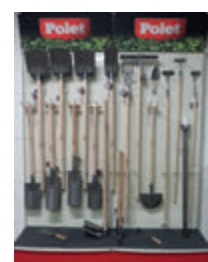
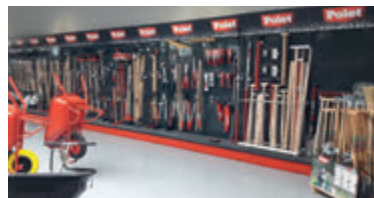

Notities

A series of horizontal dotted lines for taking notes.

Notities

A series of horizontal dotted lines for taking notes.

FORGED FOR LIFE SINCE

1865



Polet[®]

N.V. POLET QUALITY PRODUCTS S.A.
info@polet.eu | www.polet.eu