



LUMAX

POWER & LIGHTING



LUMIX
POWER & LIGHTING

EDITION
EDITIE
ÉDITION

2023

Content Inhoud Contenu

Technical information | Technische informatie | Information technique

2-4

Work lights | Werflampen | Lampes de chantier

5-28

LED-lighting | LED-verlichting | Éclairage LED

LED wall lighting | LED-wandverlichting | Éclairage LED murale

Flashlights | Zaklampen | Lampes de poche

29-40

Headlamps | Hoofdlampen | Lampes frontales

41-48

Electricity | Elektriciteit | Électricité

49-76

Accessories | Toebehoren | Accessoires

77-79



Technical information Technische informatie Information technique

Color temperature | Kleurtemperatuur | La température de la couleur

The color temperature is expressed in Kelvin. How higher the amount of Kelvin, how cooler the light and vice-versa.

De kleurtemperatuur wordt uitgedrukt in Kelvin. Hoe hoger het aantal Kelvin, hoe kouder het licht en omgekeerd.

La température de la couleur est exprimée en Kelvin. Plus le nombre est élevé, plus la lumière est froide et vice versa.

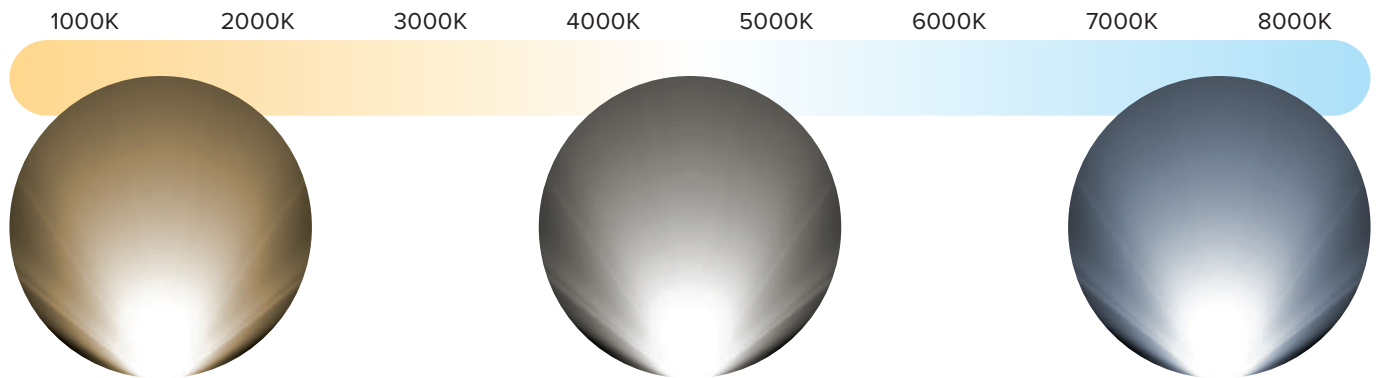

Appliance classes | Armatuurclassificaties | Classifications des lampes

Lamps can be subdivided in three classes. Each lamp has a symbol.

The higher the class, the better the lamp is protected against electric shocks.

Lampen kunnen worden onderverdeeld in drie classificaties. Bij elke lamp kan u het symbool terugvinden.

Hoe hoger de klasse, hoe beter het armatuur beschermt is tegen elektrische schokken.

Les lampes peuvent être divisées en trois classifications. Vous pouvez trouver le symbole pour chaque lampe.

Plus la classe est élevée, au mieux l'armature est protégée des chocs électriques.



CLASS 1

Lamps suffice to the electric demands of class 1, which means functional isolation in all parts plus ground.

Armaturen voldoen aan de elektrische eisen van klasse 1, d.w.z. functionele isolatie in alle onderdelen plus aardaansluiting.

Les équipements sont conformes à la classe 1 relative aux exigences électriques de mise à la terre, c'est-à-dire isolation fonctionnelle de toutes les parties et de la terminaison de mise à la terre.



CLASS 2

Lamps suffice to the electric demands of class 2, which means complete isolation in all parts, no ground. In case of a electric fault there won't be dangerous voltage on the touchable metal parts.

Armaturen voldoen aan de elektrische eisen voor dubbele isolatie van klasse 2 d.w.z. volledige isolatie in alle onderdelen, geen aardaansluiting. In het geval van een elektrisch defect komt er geen gevaarlijke spanning te staan op aanraakbare metalen onderdelen.

Les équipements sont conformes aux exigences électriques de double isolation de classe 2, à savoir l'isolation complète de toutes les parties sans prise de terre. Dans l'éventualité d'une défaillance électrique, aucune tension dangereuse ne peut atteindre les parties en métal pouvant être touchées.



CLASS 3

Lamps suffice to the electric demands of class 3, which means the protection against electric shocks is based upon a supply with extra low security voltage (SELV) and on the fact that no voltages higher than SELV can be aroused.

Armaturen voldoen aan de elektrische eisen voor drievoudige isolatie van klasse 3 d.w.z. dat de bescherming tegen elektrische schokken is gebaseerd op een voeding met een extra-lage veiligheidsspanning (SELV) en op het feit dat er geen spanningen worden opgewekt die hoger zijn dan de SELV.

Les équipements sont conformes aux exigences électriques de triple isolation de classe 3, autrement dit la protection contre le choc électrique dépend de l'alimentation maintenue à un niveau extrêmement bas pour une question de sécurité (SELV) et des tensions supérieures à celles de SELV ne sont pas générées.

IP-classification | IP-classificatie | Classification IP

The IP-code shows if the product is protected against solid particles, dust and liquids.

De IP-code toont aan in welke mate het product bescherming biedt tegen vaste voorwerpen, stof en water.

Le code IP montre dans quel mesure le produit est protégé contre les corps solides, la poussière et l'eau.



Protection against solid particles and dust
Bescherming tegen vaste voorwerpen en stof
Protection contre objets et poussière

- 0** No protection
 Geen bescherming
 Pas de protection
- 1** Protected against solid particles larger than 50 mm
 Beschermd tegen vaste voorwerpen groter dan 50 mm
 Protégé contre les corps solides supérieurs à 50 mm
- 2** Protected against solid particles larger than 12 mm
 Beschermd tegen vaste voorwerpen groter dan 12 mm
 Protégé contre les corps solides supérieurs à 12 mm
- 3** Protected against solid particles larger than 2,5 mm
 Beschermd tegen vaste voorwerpen groter dan 2,5 mm
 Protégé contre les corps solides supérieurs à 2,5 mm
- 4** Protected against solid particles larger than 1 mm
 Beschermd tegen vaste voorwerpen groter dan 1 mm
 Protégé contre les corps solides supérieurs à 1 mm
- 5** Protected against dust
 Beschermd tegen stof
 Protégé contre la poussière
- 6** Dust tight (completely protected against dust)
 Stofdicht (volledig beschermd tegen stof)
 Étanche à la poussière (totalement protégé contre la poussière)

Protection against liquids
Bescherming tegen water
Protection contre l'eau

- 0** No protection
 Geen bescherming
 Pas de protection
- 1** Protection against dripping water
 Beschermd tegen loodrecht vallende druppels
 Protégé contre la chute verticale de gouttes
- 2** Protection against tilted dripping water (max. 15°)
 Beschermd tegen druppels die vallen onder een hoek van max. 15°
 Protégé contre les gouttes tombant à un angle de max. 15°
- 3** Protection against spraying water
 Beschermd tegen regenwater
 Protégé contre la pluie
- 4** Protection against splashing of water
 Beschermd tegen waterspatten
 Protégé contre les projections d'eau
- 5** Protection against water jets
 Beschermd tegen waterstralen
 Protégé contre les jets d'eau
- 6** Protection against powerful water jets
 Beschermd tegen stortbuien
 Protégé contre les jets d'eau puissant
- 7** Protection against immersion
 Waterdicht bij onderdompeling
 Étanche en cas d'immersion
- 8** Protection against long immersion
 Beschermd tegen verblijf onder water
 Protégé contre les effets de l'immersion prolongée

Cable code | Kabelcodering | Codage du câble



Cable type | Type kabel | Type de câble

- H** Harmonized type
 Geharmoniseerd type
 Type harmonisé
- N** Standard type according to VDE
 Nationaal erkend type
 Type reconnu au niveau nationale

Nominal voltage | Nominale spanning | Tension nominale

- 05** 300/500 V
- 07** 450/750 V

Insulating materials of conductors | Isolatiemateriaal van geleiders | Matériaux d'isolation des conducteurs

- V** PVC
- R** Natural rubber | Natuurlijk rubber | Caoutchouc Naturel

Insulating materials of mantle | Isolatiemateriaal van de mantel | Matériaux d'isolation de la gaine extérieure

- V** PVC
- R** Natural rubber | Natuurlijk rubber | Caoutchouc Naturel
- N** Neoprene rubber | Neopreenrubber | Caoutchouc Néoprène

Intersection in mm² | Doorsnede in mm² | Section en mm²

Ground | Aardingsgeleider | Conducteur de terre

- G** with yellow-green ground
 met geel-groene aardingsgeleider
 avec conducteur de terre jaune-vert
- X** no yellow-green ground
 zonder geel-groene aardingsgeleider
 sans conducteur de terre jaune-vert

Number of conductors | Aantal geleiders | Nombre de conducteurs

Construction of the core | Constructie van de kern | Construction de l'âme

- F** Pliant core for flexible applications
 Soepele kern voor flexibele toepassing
 Âme souple pour des application flexible

Symbolism | Symboliek | Symbolique



Electric protection classification
Elektrische veiligheidsklasse
Classification de protection électrique



Compatible with tripod
Compatibel met statief
Compatible avec trépied



CE marking: complies with the requirements set out in European Directives
CE-markering: voldoet aan de eisen zoals vastgelegd in Europese richtlijnen
Marquage CE: conforme aux exigences énoncées dans les directives européennes



IP-classification
IP-classificatie
Classification IP



Energy saving
Energiebesparend
Economie d'énergie



Cable data
Kabelgegevens
Données du câble



Number of integrated sockets
Aantal ingewerkte stopcontacten
Nombre de prises incorporées



50% and 100% mode
50% en 100% modus
Modes 50% et 100%



25%, 50% and 100% mode
25%, 50% en 100% modus
Modes 25%, 50% et 100%



ON/OFF switch
AAN/UIT-schakelaar
Interrupteur ON/OFF



Tiltable
Kantelbaar
Inclinable



Magnetic part
Magnetisch onderdeel
Partie magnétique



Range sensor
Bereik sensor
Portée du capteur



Burn time lamp
Brandtijd lamp
Temporisation du capteur



Light intensity
Lichtsterkte
Intensité lumineuse



Charger included
Inclusief lader
Chargeur inclus



...h until fully charged
...u tot volledig opgeladen
Rechargement complet en ...h



Working time for ...h
Werktijd van ...u
Durée d'utilisation de ...h



Battery use
Batterij gebruik
Utilisation de piles



Powerbank function
Powerbank functie
Fonction Powerbank



Rechargeable via USB
Oplaadbaar via USB
Rechargeable via USB



Replaceable battery
Vervangbare batterij
Batterie remplaçable



Including lamps
Inclusief lampen
Lampes incluses



USB Connection
USB Connectie
Connection USB



Waterproof up to 1 m
Waterdicht tot 1 m
Résistant à l'eau jusqu'à 1 m



Shock resistant
Schokbestendig
Résistant aux chocs



LEDs quality
LEDs kwaliteit
Qualité des LEDs



Maximum linking of 10 luminaires
Maximaal koppelen van 10 armaturen
Raccordement maximal de 10 luminaires



LED-lighting | LED-verlichting | Éclairage LED

LED wall lighting | LED-wandverlichting | Éclairage LED murale

Work lights

Werflampen

Lampes de chantier

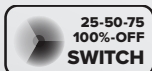

MULTI BATTERY
45W **18V**

NEW

Multi-battery LED M-45



The extremely robust and powerful multi-battery LED floodlight for professional use ensures maximum flexibility in the field thanks to the multi-battery 18V system.

De extreem robuuste en krachtige Multi accu LEDstraler voor professioneel gebruik zorgt dankzij het Multi accu 18V systeem voor maximale flexibiliteit in het vak.

Le projecteur LED multi-batterie extrêmement robuste et puissant à usage professionnel assure une flexibilité maximale sur le terrain grâce au système 18V multi-batterie.



LM 0225E
LM 03305
(pag. 78, 79)



LED M-45
COB LED TECHNOLOGY
45W/18V
MULTI BATTERY



5 battery pack adapters incl. : Bosch (LM 30101) - Makita (LM 30102) - Stanley (LM 30103) - Metabo (LM 30104) - Milwaukee/Dewalt (LM 30105)



Adapter / Adaptateur

code
LM 02995

LM 0225E
LM 03305
(pag. 78, 79)

code	i		Lm	
LM 30000	45W - 6500K	230 x 156 x 290 mm	4500	30.000 u/h

Batterij niet inbegrepen / Batterie non incluse

NEW

MULTI BATTERY
HYBRID 65W 18V

- CE
- CLASS 2
- IP 65
- 6500 Lumen
- ON/OFF SWITCH
- 25-50-75 100%-OFF SWITCH
- Changeable battery

3 year WARRANTY ON THE LED



DUAL SYSTEM

Multi-battery LED M-65

USB rechargeable

Compatible ACCUPACK 18V battery

ENERGY SAVING



3m HO7RN-F (2X 1,0 mm²)

220-240V~ 50/60Hz



LM 0225E
LM 03305
(pag. 78, 79)

The extremely robust and powerful multi-battery LED floodlight for professional use ensures maximum flexibility in the field thanks to the multi-battery 18V system or the plug-in cable connection with 3 m detachable cable.

De extreem robuuste en krachtige Multi accu LEDstraler voor professioneel gebruik zorgt dankzij het Multi accu 18V systeem of de plug-in kabelaansluiting met 3 m afneembare kabel voor maximale flexibiliteit in het vak.

Le projecteur LED multi-batterie extrêmement robuste et puissant à usage professionnel assure une flexibilité maximale sur le terrain grâce au système multi-batterie 18V ou à la connexion par câble enfichable avec câble détachable de 3 m.



LED M-65
COB LED TECHNOLOGY
65W/18V
MULTI BATTERY HYBRID



5 battery pack adapters incl. : Bosch (LM 30101) - Makita (LM 30102) - Stanley (LM 30103) - Metabo (LM 30104) - Milwaukee/Dewalt (LM 30105)



Adapter / Adaptateur

code
LM 02995

LM 0225E
LM 03305
(pag. 78, 79)

code	i	Diagram	Lm	⌚
LM 30065	65W - 6500K	250 x 157 x 313.5 mm	6500	30.000 u/h

Batterij niet inbegrepen / Batterie non incluse

MULTI BATTERY

2x50W 18V

NEW

2 year WARRANTY ON THE LED

- CE
- CLASS 3
- 6500 °K
- 12000 Lumen
- IP 20
- ENERGY SAVING

Min: 1,30 m
Max: 2,00 m

Multi-battery LED MT-100

- USB rechargeable
- Compatible ACCUPACK 18V battery
- TILTABLE
- 25-50-100%-OFF SWITCH

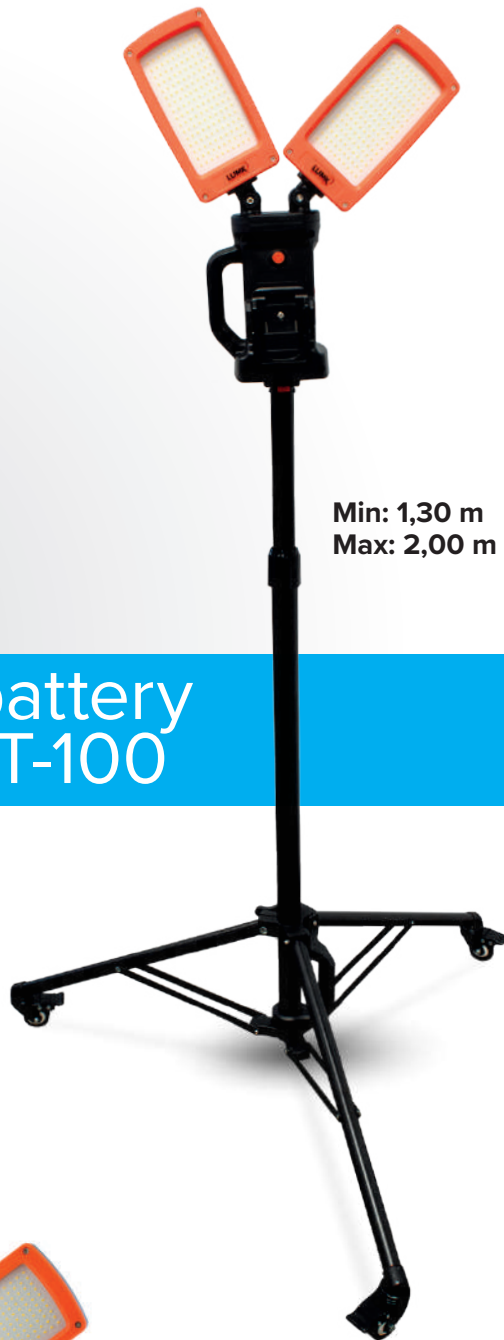

Flexible use thanks to rotatable and pivotable 2 x 50 W LED modules with a luminosity of 12000 lm. This homogeneous lighting is ideal for indoor work.

Flexibel inzetbaar dankzij draaibare en zwenkbare LED-modules van 2 x 50 W met een lichtsterkte van 12000 lm. Deze homogene verlichting is ideaal voor werkzaamheden binnen.

Utilisation flexible grâce aux modules LED rotatifs et pivotants de 2 x 50 W avec une luminosité de 12000 lm. Cet éclairage homogène est idéal pour les travaux intérieurs.



LED MT-100
SMD LED TECHNOLOGY
2x50W
MULTI BATTERY



6 battery pack adapters incl. : **Bosch** (LM 30201) - **Makita** (LM 30202) - **Stanley** (LM 30203) - **Metabo** (LM 30204) - **Milwaukee/Dewalt** (LM 30205) - **Festool** (LM 30206)



code	i		Lm	
LM 30200	2 x 50 W	850 x 850 x 1300 mm	12000	25.000 u/h

Batterij niet inbegrepen / Batterie non incluse

GALAXY
MULTI BATTERY 18V

NEW



2 year WARRANTY ON THE LED



CE

CLASS 3

6500 °K

5000 Lumen

IP 54

ENERGY SAVING

Multi-battery
GALAXY Serie

USB rechargeable

Compatible 18V battery

25-50 75-100% SWITCH

The Multi-battery GALAXY Series offers a lot of light and can also be used on a tripod. It features a soft-grip handle for optimal comfort. The two anti-slip rubbers at the front and back ensure that the lamp is always stable.

De Multi-battery GALAXY Serie biedt enorm veel licht en kan ook op een statief gebruikt worden. Het beschikt over een soft-grip handvat voor optimaal comfort. De twee anti-slip rubbers voor- en achteraan zorgen ervoor dat de lamp steeds stabiel staat.

La série multi-batterie GALAXY offre beaucoup de lumière et peut également être utilisée sur un trépied. Il est doté d'une poignée souple pour un confort optimal. Les deux caoutchoucs antidérapants à l'avant et à l'arrière garantissent que la lampe est toujours stable.



LM 0225E
LM 03305
(pag. 78, 79)



twisted support

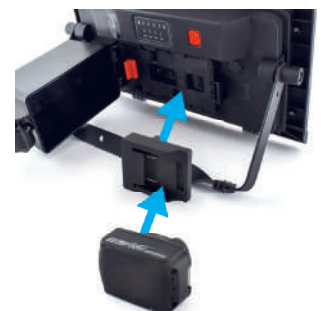

5 battery pack adapters incl. :
Bosch (LM 30101) - Makita (LM 30102) -
Stanley (LM 30103) - Metabo (LM 30104) -
Milwaukee/Dewalt (LM 30105)

GALAXY
MULTI BATTERY
SMD LED TECHNOLOGY
50W



code	i	📏	Lm
LM 30080	50W - 6500K	235 x 148 x 388 mm	5000

Batterij niet inbegrepen / Batterie non incluse



CE



LM 0225E
LM 03305
(pag. 78, 79)



GALAXY

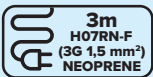

GALAXY offers a lot of light and can also be used on a tripod. It has a soft-grip handle for optimal comfort. The two antislip rubbers in front and at the back make sure the lamp stays stable.

GALAXY biedt enorm veel licht en kan ook op een statief gebruikt worden. Het beschikt over een soft-grip handvat voor optimaal comfort. De twee anti-slip rubbers voor- en achteraan zorgen ervoor dat de lamp steeds stabiel staat.

GALAXY offre beaucoup de lumière et peut également être utilisé sur un trépied. Il dispose d'une poignée soft-grip pour un confort optimal. Les deux caoutchoucs antidérapants à l'avant et à l'arrière garantissent que la lampe soit toujours stable.



GALAXY COMPACT
SMD LED TECHNOLOGY

24W

2000
Lumen



GALAXY
SMD LED TECHNOLOGY

45W

4950
Lumen



GALAXY
SMD LED TECHNOLOGY

80W

9200
Lumen



roll-up system
kabelprolsysteem
système d'enroulage de cable



twisted support

code	i	📏	Lm	🕒
LM 32232	24W - 6500K	290 x 234 x 83 mm	2000	30.000 u/h
LM 32245	45W - 6500K	385 x 315 x 90 mm	4950	30.000 u/h
LM 32300	80W - 6500K	464 x 365 x 84 mm	9200	30.000 u/h

CE

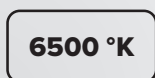

LED F-Serie

This LED-working lamp is easy to transport thanks to the pliable legs and has a comfortable PVC-handle on top and a foam rubber handle under.

Deze LED-werflamp is makkelijk te transporteren dankzij de plooibare pootjes en beschikt over een comfortabel PVC-handvat bovenaan en een schuimrubberen handvat onderaan.

Cette lampe de chantier LED est facile à transporter grâce aux pieds pliables et dispose d'une poignée confortable en PVC en haut et d'une poignée en caoutchouc mousse en dessous.



LED F-20

SMD LED TECHNOLOGY

20W

**1800
Lumen**

**1,8m
H07RN-F
(3G 1,0 mm²)
NEOPRENE**



*pliable legs
plooibare pootjes
pieds pliables*



LED F-30

SMD LED TECHNOLOGY

30W

**2500
Lumen**

**3m
H07RN-F
(3G 1,0 mm²)
NEOPRENE**



LED F-50

SMD LED TECHNOLOGY

50W

**4200
Lumen**

**3m
H07RN-F
(3G 1,0 mm²)
NEOPRENE**

code	ⓘ		Lm	⌚
LM 36120	20W - 6000K	264 x 238,5 x 148,6 mm	1800	25.000 u/h
LM 36130	30W - 6000K	288,6 x 288 x 168,5 mm	2500	25.000 u/h
LM 36150	50W - 6000K	318,5 x 308 x 183 mm	4200	25.000 u/h

CE



Min: 0,92 m
Max: 1,66 m

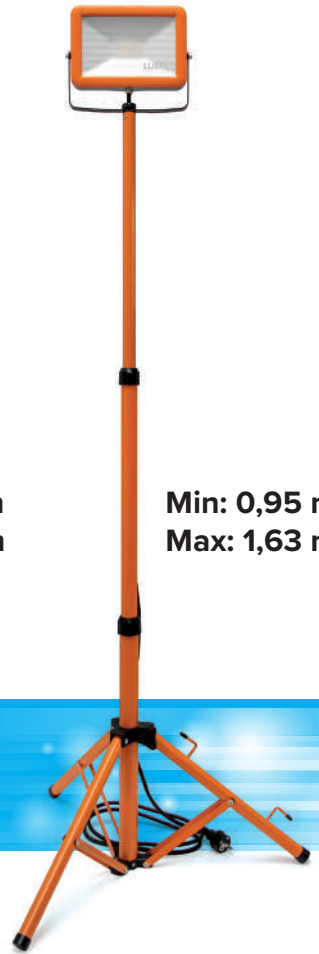

Min: 0,95 m
Max: 1,63 m

LED FT-Serie



The FT-Serie is mounted on a tripod, it can illuminate from different heights without the help of an additional person. The LED spots can be changed both horizontally and vertically.

De FT-Serie is gemonteerd op een statief en kan belichten vanop verschillende hoogtes zonder hulp van een bijkomende persoon. De LED-spots zijn zowel horizontaal als verticaal van richting te veranderen.

La Série FT est montée sur trépied permettant ainsi d'éclairer en hauteur sans l'aide d'une tierce personne. Les spots LED sont orientable tant horizontalement que verticalement.



roll-up system
kabelprolsysteem
système d'enroulage de câble

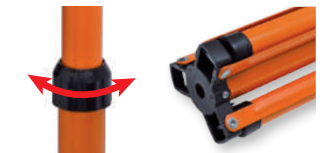

adjustable height
verstelbare hoogte
hauteur réglable

LED FT-50

SMD LED TECHNOLOGY

50W

4000
Lumen



LED FT-60

SMD LED TECHNOLOGY

2 x 30W

4200
Lumen



code	ⓘ		Lm
LM 36500	50W - 6000K	250 x 200 x 40 mm	4000
LM 36660	60W - 6000K	490 x 170 x 40 mm	4200

CE

80W

7200
Lumen

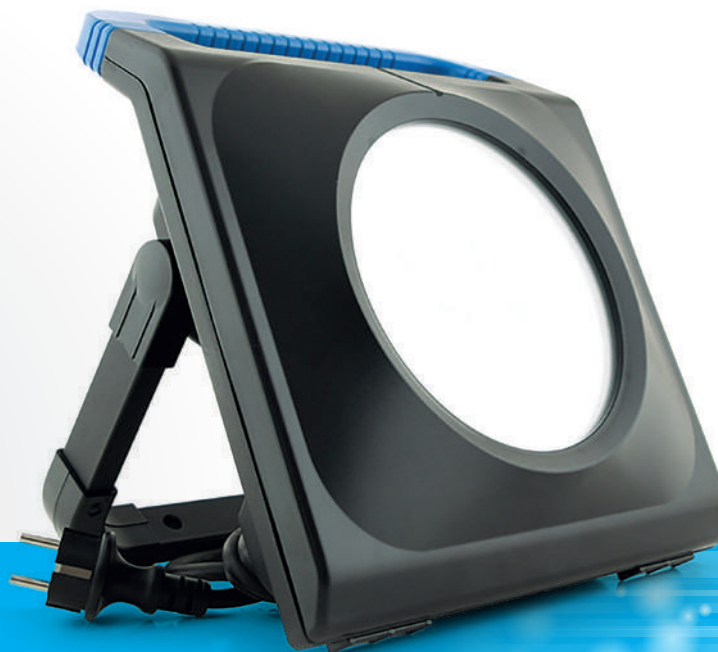

LED P-80

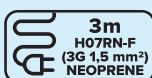

The P-80 has a strong housing. Looking in the light isn't blinding. The light has a good scatter. A handy working light with two electrical outlets to ease your job.

De P-80 heeft een sterke behuizing. In de lamp kijken, geeft geen verblindend effect. De lamp heeft een goede spreiding. Een handige werflamp met twee stopcontacten achteraan om uw job nog makkelijker te laten verlopen.

La P-80 est fabriqué en structure solide. Cette lampe n'est pas éblouissante. Celle-ci a une bonne diffusion de la lumière. Une lampe de chantier pratique grâce à ces 2 prises se trouvant sur la partie arrière qui vous permettent de brancher d'autres lampes ou des machines.



LM 0225E
(pag. 78)



LED P-80
SMD LED TECHNOLOGY
80W



code	i		Lm	
LM 33580	80W - 4000K	342 x 295 x 112 mm	7200	30.000 u/h

ALL-IN-ONE

COLOR
TEMPERATURE
SELECTION

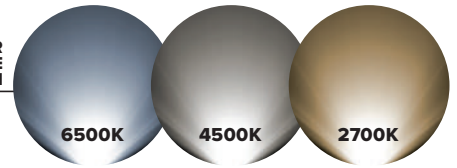

CE



LED P+Serie



The P+Series features the ultimate work lights. Changing the light color from a warm to a cool color is a must, this allows the different lighting colors to be simulated to solve any ceiling or paint errors. The lamps combine robustness, strength and versatility which makes them necessary.

De P+Serie zijn de ultieme werflampen. Het veranderen van de lichtkleur van een warme naar een koude kleur is een must, hierdoor kunnen de verschillende belichtingskleuren worden gesimuleerd om eventuele plafond- of lakfouten op te lossen. De lampen combineren robuustheid, kracht en veelzijdigheid wat hen noodzakelijk maakt.

La P+Serie sont les lampes de chantier par excellence. Le changement de couleur d'éclairage en passant d'une couleur chaude à une couleur froide est le must, cela permet la simulation des différentes couleurs d'éclairage et ceci afin de desceller les défauts de plafonnage ou de peinture. Elles sont allies robustesse, puissance et polyvalence ce qui les rendent indispensable.



roll-up system
kabelprolsysteem
système d'enroulage de cable



rubber shock protection
rubberen schokbescherming
protection antichoc en caoutchouc



LM 0225E
(pag. 78)



LED P+60
SMD LED TECHNOLOGY
60W

**5300
Lumen**



LED P+100
SMD LED TECHNOLOGY
100W

**8800
Lumen**

code	ⓘ		Lm
LM 33595	60W	300 x 305.5 x 82 mm	5300
LM 33600	100W	368 x 346 x 92 mm	8800

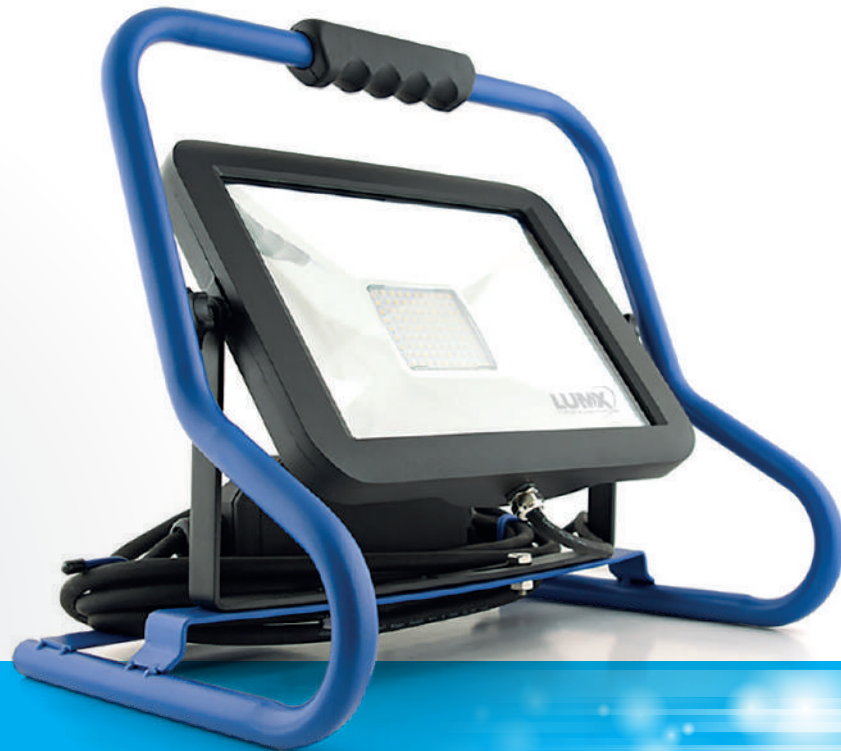

CE



LED N-Serie



The N-Series has a strong housing which offers stability and has a roll-up system. The PVC-handle is comfortable for the user.

De N-Serie heeft een sterke behuizing die bovendien stabiliteit biedt en beschikt over een kabelprolsysteem. Het PVC-handvat geeft voldoende comfort.

La N-Serie est munie d'une structure solide qui offre une excellente stabilité ainsi qu'un système d'enroulage de câble. La poignée en PVC donne un confort suffisant à son utilisation.



LED N-50
SMD LED TECHNOLOGY
50W

4580 Lumen



LED N-80
SMD LED TECHNOLOGY
80W

7200 Lumen



LED N-120
SMD LED TECHNOLOGY
120W

10800 Lumen



roll-up system
kabelprolsysteem
système d'enroulage de câble

code	i	⏏	Lm	⌚
LM 34750	50W - 4000K	330 x 315 x 220 mm	4580	30.000 u/h
LM 34780	80W - 4000K	400 x 354 x 258 mm	7200	30.000 u/h
LM 34812	120W - 4000K	500 x 440 x 295 mm	10800	30.000 u/h



CE

180W

16000
Lumen

CLASS
1

IP 54

ENERGY
SAVING

LED B-180

5m
H07RN-F
(3G 1,5 mm²)
NEOPRENE

16A + T

TILTABLE

Thanks to the very powerful structure and housing, the B-180 has stability and an excellent durability. It has a soft-grip handle for optimal comfort. In addition it has a roll-up system.

Dankzij de zeer stevige structuur en behuizing biedt de B-180 stabiliteit en een uitstekende duurzaamheid. Het PVC-handvat biedt voldoende comfort aan de gebruiker. Het beschikt bovendien over een kabelprolsysteem.

La B-180 est munie d'une structure et d'un boîtier très solide qui offre une stabilité et une durabilité excellente. La poignée en PVC donne un confort suffisant à son utilisation. Ce projecteur est muni d'un système très pratique d'enroulage de câble.

16A + T



TILTABLE



roll-up system
kabelprolsysteem
système d'enroulage de câble



LED B-180
SMD LED TECHNOLOGY
180W

code	i		Lm
LM 35180	180W - 4000K	530 x 400 x 360 mm	16000

CE

50W

5500
Lumen



LED LB-50

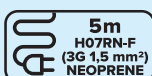

5m
H07RN-F
(3G 1,5 mm²)
NEOPRENE



16A + T



ON/OFF
SWITCH



LM 0225E
(pag. 78)

Thanks to the unique shape of the LB-50 work light you have a powerful light source that diffuses 360° light. The lamp can be placed both on the ground and on the tripod. Thanks to its practical hook on the bottom, you can easily hang it, giving you a light source from above. The sturdy housing makes it a robust work light.

Dankzij de unieke vorm van de LB-50 werflamp beschik je over een krachtige lichtbron die over 360° licht verspreid. De lamp kan zowel op de grond geplaatst worden als op het statief. Door zijn praktische haak aan de onderkant hang je hem makkelijk op waardoor je snel een lichtbron hebt van boven af. De stevige behuizing maakt het een robuuste werflamp.

Grâce à la forme unique de la lampe de chantier LB-50, vous disposez d'une source de lumière puissante qui se propage à 360°. La lampe peut être placée au sol ainsi que sur le trépied. Grâce à son crochet situé sur son socle, vous pouvez facilement suspendre la lampe pour disposer rapidement d'une source de lumière dans des endroits où aucune source de lumière n'est encore présente. Son boîtier en fait une lampe de travail robuste.



LED LB-50
SMD LED TECHNOLOGY
50W

code	i		Lm
LM 37500	50W - 6000K	280 x 286 x 280 mm	5500

CE

230W

210
Lumen/m

CLASS
2

IP 65

ENERGY
SAVING



Plug included
Inclusief stekker
Prise incluse

LS-45

1,5m
H05RN-F
(2X 1,0 mm²)
NEOPRENE

60 LED/m

45+5 m

This LED strip can be connected directly to the main supply without the intervention of a transformer or power adapter. This makes it extremely suitable for bridging long distances. The LED strip is also splash-proof and dust-proof. These characteristics, supplemented by the cool white light, make this LED strip a reliable and versatile work light that can be used as lighting in various workspaces.

Deze ledstrip kan direct op de netvoeding worden aangesloten, zonder tussenkomst van een transformator of voedingsadapter. Dit maakt dat deze uiterst geschikt is voor het overbruggen van lange afstanden. De ledstrip is ook spatwater- en stofdicht. Deze kenmerken, aangevuld met het koele witte licht, maken deze ledstrip tot een betrouwbare en veelzijdige werflamp die als verlichting in verschillende werkruimten kan worden gebruikt.

Cette bande LED peut être connectée directement au secteur sans l'intervention d'un transformateur ou d'un adaptateur secteur. Cela la rend extrêmement appropriée pour illuminer de longues distances. La bande LED est également résistante aux éclaboussures et à la poussière. Les différentes caractéristiques ainsi que sa lumière blanche froide font de cette bande LED une lampe de chantier fiable et polyvalente pouvant servir d'éclairage dans les différents espaces de travail.

LS-45

SMD LED TECHNOLOGY

128W



code	i		Lm/m	
LM 23046	6500K	264 x 251 x 128 mm	200	10.000 u/h

Only use our original accessories for mounting this LED light hose!
Gebruik enkel onze originele toebehoren voor het monteren van deze LED lichtslang!
Utilisez uniquement nos accessoires d'origine pour assembler cette bande LED!

CONTENT - INHOUD - CONTENU :

- 1x T-connector
- 3x Pin-connector
- 3x End piece / eindstuk / embout
- 1x PVC glue / lijm / colle
- 1x EU power plug / stekker / fiche + cable / kabel / câble 1,5m H05RN-F 2X 1,0 mm²



code
LM 23050



CE

24W

2650
Lumen



CLASS

1



IP 65



ENERGY
SAVING

LL-24



10m
H07RN-F
(3G 1,5 mm²)
NEOPRENE



16A + T

Max. 10



120 cm



CLIPS
INCLUDED

The LL-24 loop lighting is the most user-friendly solution for illuminating larger areas. Very easy to install with the supplied mounting clips or other solutions and easily by connecting to multiple instances of this lamp, up to a maximum of 10 armatures one after the other. The 10 meter cable on this lamp is ideal for bridging the distance between the lamps when looping them. Due to the white cap, the lamp is by no means blinding and can be used in various positions.

De LL-24 doorlusverlichting is de meest gebruiksvriendelijke oplossing voor het verlichten van grotere oppervlakten. Heel makkelijk te plaatsen door de meegeleverde bevestigingsclips of via andere oplossingen en heel eenvoudig door te koppelen aan meerdere exemplaren van deze lamp, dit tot een maximum van 10 armaturen na elkaar. De 10 meter kabel aan deze lamp zijn ideaal om de afstand tussen de lampen te overbruggen bij het doorlussen ervan. Door de witte kap is de lamp geenszins verblindend en kan ze in verschillende posities gebruikt worden.

L'éclairage en boucle LL-24 est la solution la plus conviviale pour éclairer des zones plus vastes. Très facile à installer grâce aux clips de fixation inclus ou à d'autres solutions. Elle est très facilement raccordable à d'autres lampes identiques et ce jusqu'à 10 pièces. Le câble de 10 mètres est idéal pour combler la distance entre les lampes lors de la boucle. En raison de son écran blanc, son éclairage n'est en aucun cas aveuglant et peut être ainsi utilisé dans différentes positions.



LL-24

SMD LED TECHNOLOGY

24W



Max. 10



CLIPS
INCLUDED



code	i	📏	Lm
LM 36724	24W - 6400K	1200 x 72 x 58 mm	2650



CE



LED HP-Serie

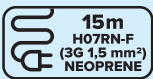

The HP-Serie can be attached to a wall or a tripod. The working lamp is very compact, so it can be used everywhere. The long life span is another advantage.

De HP-Serie kan worden bevestigd aan een muur of op een statief. De lamp is zeer compact waardoor het overal gebruikt kan worden. De lange levensduur is nog een extra pluspunt.

La HP-Serie peut être fixée à un trépied mais également à un mur. La lampe est très compacte et peut dès lors être utilisée dans de nombreuses situations. Sa longue durée de vie et sa puissance sont des avantages à ne surtout pas négliger.



LED HP-150

SMD LED TECHNOLOGY

150W

13400 Lumen



LED HP-200

SMD LED TECHNOLOGY

200W

18250 Lumen



LED HP-400

SMD LED TECHNOLOGY

400W

37600 Lumen



LED HP-600

COB LED TECHNOLOGY

600W

HIGH LUMEN



60000 Lumen



LM 0225E
LM 03305
(pag. 78, 79)



code	ⓘ	📏	Lm
LM 61015	150W - 6500K	345 x 280 x 68 mm	13400
LM 61020	200W - 6500K	425 x 325 x 77 mm	18250
LM 61040	400W - 6500K	595 x 475 x 95 mm	37600
LM 61260	600W - 6500K	560 x 470 x 110 mm	60000



CE



3 year WARRANTY ON THE LED

WS-Serie

The **WS-Serie** can be attached to a wall. The working lamp is very compact, so it can be used everywhere. The long life span is another advantage.

De **WS-Serie** kan worden bevestigd aan een muur. De lamp is zeer compact waardoor het overal gebruikt kan worden. De lange levensduur is nog een extra pluspunt.

La **WS-Serie** peut être fixée au mur. La lampe est très compacte ce qui la rend utilisable un peu partout. Sa longue durée de vie est l'un des avantages supplémentaires qu'offre cet appareil.



WS-20

SMD LED TECHNOLOGY

20W

**1800
Lumen**



WS-30

SMD LED TECHNOLOGY

30W

**2500
Lumen**



WS-50

SMD LED TECHNOLOGY

50W

**4200
Lumen**

code	i	⏏	Lm	⌚
LM 31320	20W - 4000K	174 x 130 x 76 mm	1800	30.000 u/h
LM 31330	30W - 4000K	224 x 168 x 80 mm	2500	30.000 u/h
LM 31350	50W - 4000K	258 x 192 x 83,5 mm	4200	30.000 u/h

(((**SENSOR**)))

CE



3 year WARRANTY ON THE LED

WSS-Serie with sensor / met sensor / avec capteur



The **WSS-Serie** can be attached to a wall and is equipped with an adjustable motion sensor, so no energy is wasted. The working lamp is very compact, so it can be used everywhere. The long life span is another advantage.

De **WSS-Serie** kan worden bevestigd aan een muur en is voorzien van een verstelbare bewegingssensor waardoor geen energie verspild wordt. De lamp is zeer compact waardoor het overal gebruikt kan worden. De lange levensduur is nog een extra pluspunt.

La **WSS-Serie** peut être fixée au mur et elle est équipée d'un capteur de mouvement orientable afin de ne pas gaspiller d'énergie. La lampe est très compacte ce qui la rend utilisable un peu partout. Sa longue durée de vie est l'un des avantages supplémentaires qu'offre cet appareil.



WSS-20

SMD LED TECHNOLOGY

20W

1800 Lumen



WSS-30

SMD LED TECHNOLOGY

30W

2500 Lumen



WSS-50

SMD LED TECHNOLOGY

50W

4200 Lumen

code	i	Diagram	Lm	⌚
LM 31720S	20W - 4000K	192 x 60 x 225 mm	1800	30.000 u/h
LM 31730S	30W - 4000K	224 x 80 x 250 mm	2500	30.000 u/h
LM 31750S	50W - 4000K	278 x 70 x 335 mm	4200	30.000 u/h



CE

30W

2400
Lumen

CLASS
3

IP 54

ENERGY
SAVING



GALAXY Rechargeable

incl.

**±7-8
hrs**

**2,5
4,5
hrs**

**11,1 V
4400 mAh
LITHIUM**

**50-100%
SWITCH**



LM 0225E
LM 03305
(pag. 78, 79)

GALAXY Rechargeable offers all the advantages of Galaxy plus the possibility to recharge. It also offers a lot of light and it can be used on a tripod. It has a soft-grip handle for optimal comfort.

GALAXY Rechargeable dat betekent alle voordelen die de Galaxy biedt met daarbovenop de mogelijkheid om op te laden! Enorm veel licht en het kan ook op een statief gebruikt worden. Het beschikt over een soft-grip handvat voor optimaal comfort.

GALAXY Rechargeable offre tous les avantages que le modèle Galaxy offre avec la possibilité de rechargement en plus. Il offre aussi beaucoup de lumière et peut également être utilisé sur un trépied. Il dispose d'une poignée soft-grip pour un confort optimal.



GALAXY
SMD LED TECHNOLOGY
30W
RECHARGEABLE



twisted support

code			Lm
LM 32230	30W - 6500K	385 x 315 x 70 mm	2000

CE

20W

1600
Lumen

CLASS
3

IP 54

ENERGY
SAVING



GALAXY R-Compact

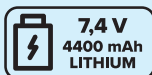

GALAXY R-Compact is a compact solution which offers a lot of light. It has a soft-grip handle for optimal comfort. The two antislip rubbers in front and at the back make sure the lamp stays stable. A charger is included with the lamp.

GALAXY R-Compact is een compacte oplossing die ontzettend veel licht biedt. Het beschikt over een soft-grip handvat voor optimaal comfort. De twee anti-slip rubbers voor- en achteraan zorgen ervoor dat de lamp steeds stabiel staat. De lamp is op te laden via USB.

GALAXY R-Compact est une solution compacte qui offre beaucoup de lumière. Elle dispose d'une poignée soft-grip pour un confort optimal. Les 2 patins en caoutchouc antidérapants à l'avant et à l'arrière garantissent une stabilité de la lampe. La lampe est livrée avec un chargeur.



LM 0225E
LM 03305
(pag. 78, 79)



**GALAXY
R-COMPACT**
SMD LED TECHNOLOGY
20W
RECHARGEABLE



twisted support

code	i		Lm
LM 32228	20W - 6500K	290 x 234 x 68 mm	1600



DUAL SYSTEM

CE

50W

5000
Lumen



LED RS-50

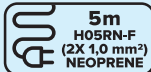
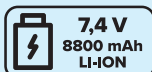

LM 0225E
(pag. 78)



LED RS-50
COB LED TECHNOLOGY
50W
RECHARGEABLE

The RS-50 can be used with a battery or with a cable. Due to the 2 modes, you can choose the amount of light. The soft-grip handle offers extra comfort for the user.

De RS-50 is zowel te gebruiken op batterij als via kabel. De RS-50 heeft 2 lichtstanden, waardoor u zelf de hoeveelheid licht kan bepalen. Het soft-grip handvat geeft extra comfort.

La lampe RS-50 est utilisable sur batterie tout comme sur cable. La RS-50 est utilisable en 2 modes, grâce à cela vous pouvez déterminer vous-même la quantité de lumière dont vous avez besoin. La poignée soft-grip fournit un confort supplémentaire.

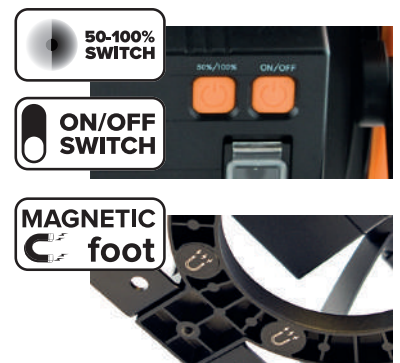

code	i	Dimensions	Lm	⌚
LM 30350	50W - 5000K	300 x 265 x 130 mm	5000	30.000 u/h

Vervangbatterij Batterie de recharge



code
LM 30355



LED R-Serie



The R-Series has a handle in foam, which is comfortable for the user. It's a rechargeable lamp which lasts 2,5 hours. The feet of this lamp are magnetic, therefore they can be placed anywhere.

De R-Serie heeft een handvat in schuim, voor extra comfort. Het is een oplaadbare lamp die maar liefst 2,5 uur meegaat. Het heeft magnetische pootjes en kan dus werkelijk overal geplaatst worden.

La R-Serie est munie d'une poignée en mousse pour un confort supplémentaire. Une lampe rechargeable qui est utilisable pas moins de 2h30. Cette lampe de chantier est munie de pieds magnétiques, ce qui lui permet d'être positionner où vous le souhaitez.



LED R-10
SMD LED TECHNOLOGY
10W
RECHARGEABLE

800 Lumen



LED R-20
SMD LED TECHNOLOGY
20W
RECHARGEABLE

1600 Lumen



code	i		Lm
LM 32010	10W - 4000K	239 x 167 x 118 mm	800
LM 32020	20W - 4000K	286,5 x 221,5 x 133 mm	1600

CE

10W

1000
Lumen

CLASS
3

IP 54

ENERGY
SAVING



NEW



LED XS-10

incl.

±2-3
hrs

±6-8
hrs

3,7 V
2200 mAh
LITHIUM

USB
rechargeable

25-50-100%
FLASH-OFF
SWITCH

The XS-10 is a small size rechargeable lamp that can be used on all construction sites. The compactness of this lamp is exceptional, it can be used anywhere without taking too much space. The aluminum housing makes it a robust and durable lamp.

De XS-10 is een oplaadbare lamp van klein formaat die op alle bouwerven kan worden gebruikt. De compactheid van deze lamp is uitzonderlijk, het kan overal gebruikt worden zonder te veel ruimte in beslag te nemen. De aluminium behuizing maakt het een robuuste en duurzame lamp.

La XS-10 est une lampe rechargeable petit format utilisable sur tous vos chantiers. Sa compactibilité est l'un des atouts recherchés afin de pouvoir être utilisé sans prendre trop de place. Son boîtier en aluminium fait d'elle une lampe robuste et durable.



*with carabiner and magnetic holder
met karabijnhaak en magnetische houder
avec mousqueton et support magnétique*

LED XS-10
COB LED TECHNOLOGY
10W
RECHARGEABLE

code	i		Lm
LM 16410	10W - 6500K	100 x 100 x 40 mm	1000

CE

15W

1200
Lumen

CLASS
3

IP 54

ENERGY
SAVING

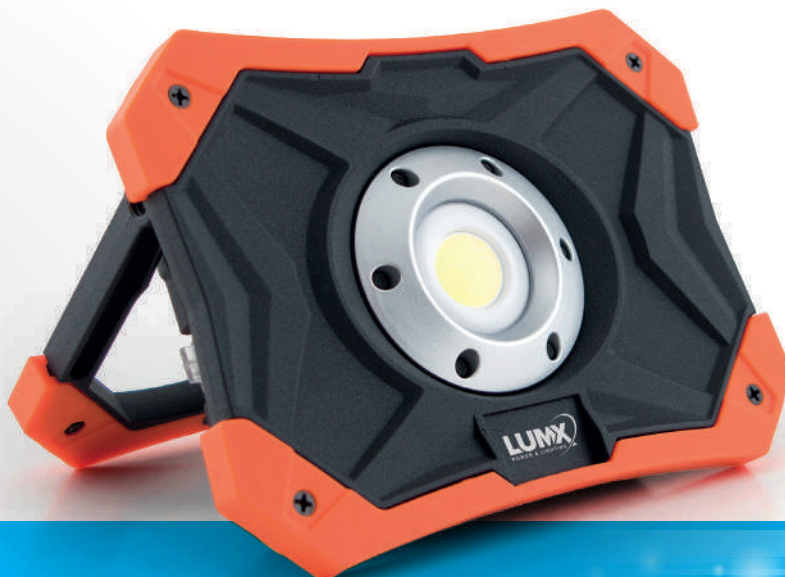

LED XS-15

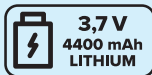

The XS-15 is a small size rechargeable lamp that can be used on all construction sites. The compactness of this lamp is exceptional, it can be used anywhere without taking too much space. The aluminum housing makes it a robust and durable lamp.

De XS-15 is een oplaadbare lamp van klein formaat die op alle bouwerven kan worden gebruikt. De compactheid van deze lamp is uitzonderlijk, het kan overal gebruikt worden zonder te veel ruimte in beslag te nemen. De aluminium behuizing maakt het een robuuste en duurzame lamp.

La XS-15 est une lampe rechargeable petit format utilisable sur tous vos chantiers. Sa compactibilité est l'un des atouts recherchés afin de pouvoir être utilisé sans prendre trop de place. Son boîtier en aluminium fait d'elle une lampe robuste et durable.



magnetic holder included
incl. magnetische houder
support magnétique inclus

LED XS-15
COB LED TECHNOLOGY
15W
RECHARGEABLE

code	i	📏	Lm
LM 16515	15W - 6500K	171 x 124 x 43,5 mm	1200



Flashlights
Zaklampen
Lampes de poche





CE

200
Lumen

CLASS
3

IP 20

ENERGY
SAVING

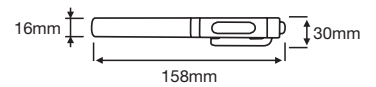

PEN LIGHT

±4
hrs

3 x AAA
(incl.)

6
LED

STRONG
ALU BODY

The PEN LIGHT has the same size as a biro. Thanks to the SMD-LED there's a lot of light. Because of its robuste structure, the life span is very long. The batteries can very easy be replaced.

De PEN LIGHT heeft dezelfde grootte als een balpen. Dankzij de SMD-LED komt er veel licht vrij. Door de robuustheid van de zaklamp is de levensduur zeer hoog. De batterijen kunnen heel makkelijk worden vervangen.

La PEN LIGHT est de la même grandeur qu'un stylo à bille. Elle développe beaucoup de lumière et ce grâce aux LED SMD. En raison de la robustesse de la lampe, la durée de vie est très élevée.

180°
turnable magnetic clip
draaibare magnetische clip
clip magnétique rotatif



Display
16 st/pcs



PEN LIGHT
SMD LED TECHNOLOGY
BATTERY



code	i	158 x 30 x 16 mm	Lm
LM 51955	6500K	158 x 30 x 16 mm	200



CE

80 Lumen

CLASS **3**

IP **20**

ENERGY SAVING



SMD-Led



10 Lumen

Led bulb
Led à diode

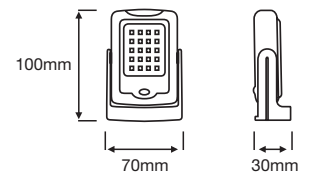

DUO LED

±10 hrs

3 x AAA (incl.)

20+3 LED

MAGNETIC foot

The DUO LED has two kinds of LED: a bulb and SMD-Led. There are also different ways of hanging up the flashing light. It is absolutely a must-have!

De DUO LED beschikt over twee soorten LED: een bulb en SMD-Led. Ook de verschillende ophangmanieren, maken van de zaklamp een must-have!

La DUO LED est munie de 2 types de LED: led à diode et SMD. Les différentes manières de suspensions font de cette lampe un outil primordial.



Magnetic foot
Magnetische voet
Pied magnétique



Hangable
Ophangbaar
Mise en suspension



Display
12 st/pcs

DUO LED

BULB & SMD LED TECHNOLOGY

BATTERY

code	i	Dimensions	Lm
LM 52000	4000K	100 x 70 x 30 mm	80

CE

280
Lumen

CLASS
III
3

IP 20

±3
hrs

ENERGY
SAVING



COB-Led



25
Lumen

Led bulb
Led à diode

INSPEC DUO LED GRIP

3 x AA
(incl.)

MAGNETIC
back

MAGNETIC
foot

The INSPEC DUO LED GRIP has two kinds of LED: a bulb and COB-LED. The soft-grip handle assures that the flashlight is comfortable when using. And with one touch on the button you can turn it on and off.

De INSPEC DUO LED GRIP beschikt over twee soorten LED: een bulb en COB-LED. Het soft-grip handvat zorgt ervoor dat de zaklamp comfortabel in de hand ligt. Met één druk op de knop zet u de zaklamp aan of uit.

La INSPEC DUO LED GRIP est munie de 2 types de LED: led à diode et COB-LED. La poignée en soft-grip fait de cette lampe un outil confortable en main. Il suffit d'une pression sur la bouton pour éteindre et allumer la lampe.



Magnetic back
Magnetische achterkant
Partie arrière magnétique



Magnetic foot
Magnetische voet
Pied magnétique



Hangable
Ophangbaar
Mise en suspension

Display
9 st/pcs



**INSPEC
DUO LED GRIP**
COB LED TECHNOLOGY
BATTERY

code	i		Lm
LM 52070	6500K	215 x 53 x 45 mm	280



CE

300
Lumen

CLASS
3

IP 20

ENERGY
SAVING

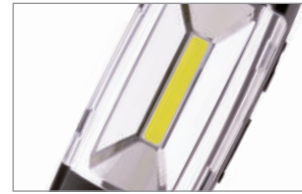

COB-Led



30
Lumen

Led bulb
Led à diode



360°

INSPEC DUO GRIP

4
hrs

4
hrs

3,7 V
2600 mAh
Lithium

USB
rechargeable

MAGNETIC
foot

TILTABLE

POWER
BANK
FUNCTION

The INSPEC DUO GRIP flashlight has two types of LED: a bulb and COB-LED. The soft-grip handle ensures that the flashlight is comfortable to hold. You can attach the flashlight quickly and easily with the hook or magnetic base so that your hands are always free. In addition, the base can be rotated 360 degrees. If you do not use the lamp for illuminating an object, you can always use it as a power bank to charge small electronic devices such as your tablet or smartphone.

De zaklamp INSPEC DUO GRIP beschikt over twee soorten LED: een bulb en COB-LED. Het soft-grip handvat zorgt ervoor dat de zaklamp comfortabel in de hand ligt. Met de haak of magnetische voet bevestig je de zaklamp snel en eenvoudig zodat je je handen altijd vrij hebt. Bovendien is de voet 360 graden roteerbaar. Wanneer u de lamp niet gebruikt voor het belichten van een object kan u hem ook altijd gebruiken als powerbank om kleine elektronische toestellen zoals je tablet of smartphone op te laden.

La INSPEC DUO GRIP est munie de 2 types de LED: led à diode et COB. La poignée en soft-grip fait de cette lampe un outil confortable en main. Avec le crochet ou la base magnétique, vous pouvez attacher la lampe de poche rapidement et facilement pour que vous ayez toujours les mains libres. De plus, la base peut être pivotée à 360 degrés. Si vous n'utilisez pas la lampe pour éclairer un objet, vous pouvez toujours l'utiliser comme source d'alimentation pour recharger de petits appareils électroniques tels que votre tablette ou votre smartphone.

MAGNETIC
foot



INSPEC DUO GRIP
COB LED TECHNOLOGY
3W
RECHARGEABLE

Hangable
Ophangbaar
Mise en suspension

Tilttable
Kantelbaar
Inclinable



code	i	Dimensions	Lm
LM 52111	3W - 7000K	245 x 58,5 x 45,8 mm	300



CE

**800
Lumen**

CLASS
3

IP 54

ENERGY
SAVING



SMD-Led



**80
Lumen**

Led bulb
Led à diode

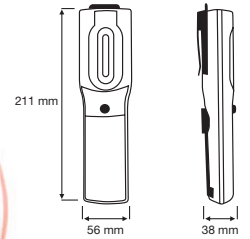

INSPEC PRO

±5
hrs

±3
hrs

3,7V
4400 mAh
LI-ION

incl.

MAGNETIC
foot

TILTABLE

USB-C
rechargeable

The INSPEC PRO has a belt clip which makes it easy to carry around. The feet is pliable and magnetic, this makes it possible to illuminate every angle.

De INSPEC PRO heeft een gordelclip waardoor het makkelijk mee te nemen is. De voet is plooibaar én magnetisch, waardoor elke hoek te belichten is.

La INSPEC PRO est munie d'un crochet d'attache pour ceinture qui la rend facile à transporter. Le pied est pliable et magnétique de sorte que chaque coins soient éclairés.



Magnetic foot
Magnetische voet
Pied magnétique



Hangable
Ophangbaar
Mise en suspension



Pliable foot
Plooibare voet
Pied pliable



Attachable with clip
Bevestigbaar met clip
Clip de fixation

code	i		Lm
LM 52125	5W - 7000K	211 x 56 x 38 mm	500

CE

500 Lumen

CLASS **3**

IP **20**

ENERGY SAVING

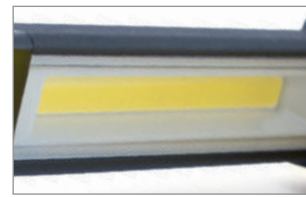

COB-Led



1W Led



INSPEC UV

3 hrs

3,7 V
2200 mAh
LITHIUM

USB
rechargeable

MAGNETIC
foot

POWER
BANK
FUNCTION

This inspection lamp is the Swiss army knife under the lamps. It can be rotated 360°, tilted and is hangable thanks to the hook. It has 4 modes including 100% brightness - 50% - flashlight - UV. The UV-mode is used for leak detection in hydraulic and even mechanical systems.

Deze inspectielamp is het Zwitserse zakmes onder de lampen. Het is 360° draaibaar, kantelbaar en is ophangbaar dankzij de haak. Het heeft 4 standen waaronder 100% helderheid - 50% - zaklamp - UV. De UV-modus wordt gebruikt voor lekdetectie bij hydraulische en zelfs mechanische systemen.

Cette lampe d'inspection est le couteau suisse des lampes. Elle est orientable à 360°, inclinable, avec mise en suspension possible grâce à son crochet. Elle est munie de 4 modes tels que luminosité à 100% - 50% - Lampe de poche - UV. Le mode UV est utilisé pour la détection des fuites dans des systèmes hydrauliques et même mécaniques.



4 modes
100% - 50% - Top - UV

Multifunction switch and battery indicator
Multifunctionele schakelaar en batterij-indicator
Interrupteur multifonction et indicateur de batterie



Magnetic foot
Magnetische voet
Pied magnétique



Hangable
Ophangbaar
Mise en suspension

INSPEC UV
COB LED TECHNOLOGY
5W
RECHARGEABLE

code	i	📏	Lm
LM 51005	5W - 6500K	298 x 49 x 35 mm	500

Available from the beginning of 2021.
Verkrijgbaar vanaf begin 2021.
Disponible à partir du début 2021.



SMD-Led



**1000
Lumen**



LED T-1000



4 hrs



4 hrs

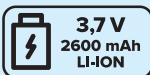

3.7V
2600 mAh
LI-ION



USB
rechargeable



**POWER
BANK
FUNCTION**

The T-1000 flashlight is a powerful, compact and robust version. Thanks to the USB mode, it can be charged and gives the option to charge a phone or other device. The light beam is adjustable making it possible to concentrate all the power at an accurate point.

De T-1000 zaklamp is een krachtige, compacte en robuuste versie. Dankzij de USB-modus kan hij worden opgeladen en geeft hij de mogelijkheid een telefoon of een ander apparaat op te laden. De lichtstraal is verstelbaar waardoor het mogelijk is om al het vermogen op een nauwkeurig punt te concentreren.

La lampe de poche T-1000 est une version puissante, compacte et robuste. Son mode USB lui permet d'être chargée et lui donne la possibilité de recharger un téléphone ou tout autre appareil. Le faisceau lumineux est réglable lui donnant la possibilité de concentrer toute la puissance sur un point précis.

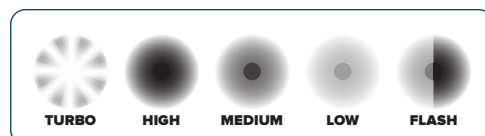

Display
6 st/pcs



- 1 Micro USB port (recharging)
- 1 USB port (Power Bank function)
- 1 Micro USB-poort (opladen)
- 1 USB-poort (Power Bank-functie)
- 1 port micro USB (charge)
- 1 port USB (fonction Power Bank)



code	i	Barcode	Lm
LM 15095	10W - 7100K	Ø 29 x 150 mm	1000



950
Lumen



T-GUN 950



4 hrs



1,5 hrs

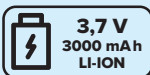

3,7 V
3000 mAh
LI-ION



USB
rechargeable



POWER
BANK
FUNCTION

The T-GUN 950 lamp is easy to transport and use thanks to its gun shape. It has a shoulder strap and a wrist strap. Thanks to the USB port, it can be charged and can also charge a phone or other device. The integrated structure of the lamp allows hands-free use.

De T-GUN 950-lamp is gemakkelijk te vervoeren en te gebruiken dankzij de pistoolvorm. Het heeft een schouderband en een polsband. Dankzij de USB-poort kan hij worden opgeladen en kan hij ook een telefoon of een ander apparaat opladen. De ingewerkte structuur van de lamp maakt handenvrij gebruik mogelijk.

La lampe torche T-GUN 950 est facile à transporter et à utiliser grâce à sa forme de pistolet. Elle est munie d'une bandoulière et d'une dragonne. Son port USB lui permet d'être rechargée et également de charger un téléphone ou tout autre appareil. La structure incluse à la lampe permet une utilisation mains libres.

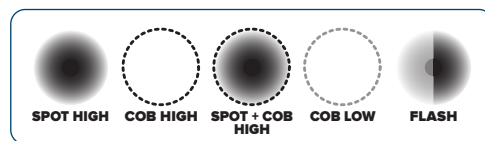

SPOT HIGH COB HIGH SPOT + COB HIGH COB LOW FLASH

	Lm	m	
SPOT HIGH	950 Lm	510 m	1 u/h 15 min
COB HIGH	750 Lm	39 m	1 u/h 45 min
SPOT + COB HIGH	1400 Lm	480 m	1 u/h
COB LOW	45 Lm	10 m	20 u/h
8Hz FLASHING	N/A	N/A	3 u/h



T-GUN 950
SMD LED TECHNOLOGY
12W
RECHARGEABLE



USB
rechargeable



With carrying string
Met draaglint
Avec bandoulière



Handsfree
Handenvrij
Mains libres

code			Lm
LM 18625	12W - 6100K	148 x 165 x 76 mm	950

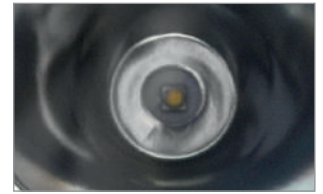

SMD-Led



**330
Lumen**

LIGHT BY
CREE
LEDs

IP X4

LM 16330



The flashlight can be put on a foot. Or you can carry it with a string. The battery lasts for 25 hours!

De zaklamp kan staan op een voetje. Of u kan het dragen met een touwtje over uw schouder. De batterij van de lamp gaat 25 uur mee.



La lampe torche est utilisable sur pied. Elle peut également être utilisée avec bandoulière. La durée d'utilisation de la lampe est de 25 heures.



Tiltable
Kantelbaar
Inclinable



With carrying string
Met draaglint
Avec bandoulière



code			Lm
LM 16330	6000K	188 x 148 x 128 mm	330



CE

**3500
Lumen**

LIGHT BY
CREE
LEDs

IP 67

**ENERGY
SAVING**

SMD-Led



TURBO PRO

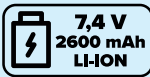

The TURBO flashlight is a powerful lamp that illuminates up to 400 meters. Thanks to the aluminum structure, this flashlight is a must-have on every construction site, but it can also be useful in everyday life.

De TURBO-zaklamp is een krachtige lamp die verlicht tot wel 400 meter. Dankzij de aluminium structuur is deze zaklamp een must-have op elke werf, maar het kan ook van pas komen in het dagelijks leven.

La lampe torche TURBO est une lampe de haute puissance diffusant la lumière jusqu'à une porte de 400 mètres. Sa structure en aluminium fait d'elle une alliée lors de vos interventions que ce soit sur chantier ou dans la vie de tous les jours.

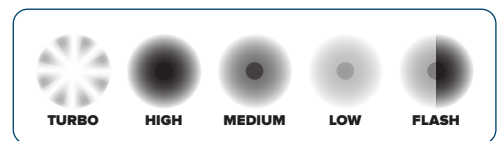

**With LOCK-system
Met LOCK-systeem
Avec LOCK-système**



**Waterproof up to 1 meter
Waterdicht tot 1 meter
Résistant à l'eau et ce jusqu'à
1 mètre de profondeur**



**With carrying string
Met draaglint
Avec dragone**

	Lm		
TURBO	3500 Lm	400 m	± 2 u/h
HIGH	1500 Lm	275 m	± 3 u/h
MED	500 Lm	155 m	± 8 u/h
LOW	100 Lm	70 m	± 40 u/h
8Hz FLASHING	N/A	N/A	± 8 u/h

code			Lm
LM 17005	28W - 6500K	Ø 62 x 247 mm	3500



Headlamps
Hoofdlampen
Lampes frontales

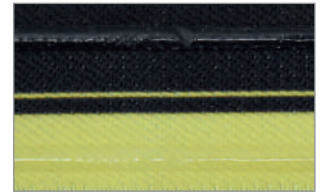

Anti-slip strips
Antislipstrips
Bandes antidérapantes



180
Lumen

LIGHT BY
CREE
LEDs

IP X4



HL-180

3 x AAA
DURACELL
(incl.)

SHOCK
RESISTANT
1m

This head lamp is 180° tiltable, compact and easy to use. It has 6 operating modes. The sliding diffuser offers you the option of more focused lighting or to use a wider beam of light. It is also possible to temporarily attach the lamp to a safety helmet thanks to the adhesive mount for safety helmet that is also supplied with the lamp.

Deze hoofdlamp is 180° kantelbaar, compact en gemakkelijk te gebruiken. Ze heeft 6 gebruiksstanden. De verschuifbare diffuser biedt u de mogelijkheid om gericht te verlichten of om een bredere lichtstraal te gebruiken. Het is ook mogelijk om de lamp tijdelijk op een veiligheidshelm te bevestigen dankzij de zelfklevende bevestiging voor de veiligheidshelm die ook bij de lamp is geleverd.

Cette lampe frontale est inclinable à 180°, compacte et facile à utiliser. Elle comporte 6 différents modes d'utilisation. Son diffuseur coulissant vous donne la possibilité de mieux cibler l'espace à éclairer ou d'utiliser un faisceau plus large. Il est également possible de fixer temporairement la lampe sur un casque de sécurité grâce au support adhésif pour casque de sécurité qui est également fourni avec la lampe.

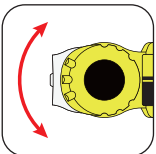

180° tiltable
180° kantelbaar
Inclinaison à 180°

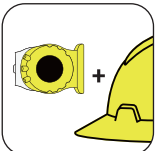

Adhesive mount for safety helmet
Zelfklevende bevestiging voor veiligheidshelm
Support adhésif pour casque de sécurité

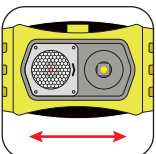

With sliding diffuser
Met verschuifbare diffuser
Avec diffuseur coulissant

6 modes

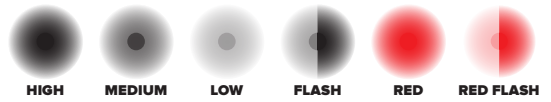

	Lm	Beam Distance (m)	Battery Life (h)
HIGH	180 Lm	85 m	± 7,5 u/h
MED	80 Lm	55 m	± 20 u/h
LOW	20 Lm	30 m	± 60 u/h
FLASH	N/A	N/A	± 50 u/h
RED	5 Lm	13 m	± 120 u/h
RED FLASH	N/A	N/A	± 180 u/h

FOCUSED



DIFFUSED



code	①	Dimensions	Lm
LM 12180	5200K - 7200K	38 x 70 x 50 mm	180



Anti-slip strips
Antislipstrips
Bandes antidérapantes



250
Lumen

LIGHT BY
CREE
LEDs

IP 64

HL-250

Incl. 3,7 V
800 mAh
LI-POLYMER

±2,5
hrs

or / of / ou

3 x AAA
(not incl.)

2m
SHOCK
RESISTANT

USB
rechargeable

Changeable
battery

This head lamp is 90° tiltable, robust and compact. It has 5 operating modes. The exposure focus is adjustable thanks to the rotating wheel that covers the lamp. The light intensity is 250 lumens and is ideal for solving problems in poorly lit areas. The lighting system is rechargeable thanks to the USB cable.

Deze hoofdlamp is 90° kantelbaar, robuust en compact. Het heeft 5 gebruiksstanden. De belichtingfocus is instelbaar dankzij het draibare wiel die de lamp omvat. De lichtsterkte bedraagt 250 lumen en is ideaal voor het oplossen van problemen in slecht verlichte gebieden. Het verlichtingssysteem is oplaadbaar dankzij de USB-kabel.

Cette lampe frontale est inclinable à 90°, robuste et compacte. Elle comporte 5 modes d'utilisation. La mise au point de l'éclairage est réglable grâce à la molette qui surmonte la lampe. Sa puissance est de 250 lumens et est idéale pour les travaux de dépannage dans les endroits peu éclairés. Le système d'éclairage est rechargeable grâce au câble USB.

5 modes

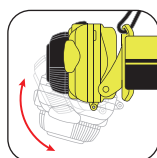

90° tiltable
90° kantelbaar
Inclinaison à 90°

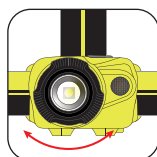

Adjustable focus
Verstelbare focus
Mise au point réglable

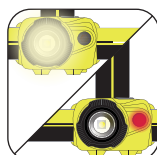

Dual light sources
Dubbele lichtbronnen
Deux sources de lumière

	Lm		
HIGH	250 Lm	125 m	± 7 u/h
MED	115 Lm	80 m	± 14 u/h
LOW	10 Lm	28 m	± 45 u/h
RED	10 Lm	5 m	± 15 u/h
RED FLASH	N/A	N/A	± 30 u/h



LM 12997

code			Lm
LM 12325	6100K - 7100K	62 x 41 x 43 mm	250
Battery / Batterij / Batterie			
LM 12997	3,7 V - 800 mAh	43 x 32 x 11 mm	-

(((**SENSOR**)))



Flexible rubber band
Flexibele rubberen band
Bande de caoutchouc souple

CE

350
Lumen

LIGHT BY
CREE
LEDs

IP X4



HL-350

incl. 3,7 V
1200 mAh
LITHIUM

±2,5
hrs

230°

SHOCK
RESISTANT
2m

USB
rechargeable

This wide-beam headlamp has a light intensity of 350 lumens and is equipped with a motion sensor. It is easy to operate with one-button switching between high/medium modes. This headlamp has a comfortable elastic band that is easy to adjust to any head.

Deze breedstralende hoofdlamp heeft een lichtsterkte van 350 lumen en is uitgerust met een bewegingssensor. Hij is gemakkelijk te bedienen door met één knop over te schakelen tussen de standen high/medium. Deze hoofdlamp heeft een comfortabele elastische band die gemakkelijk aan te passen is aan elk hoofd.

Cette lampe frontale à faisceau large a une intensité lumineuse de 350 lumens et est équipée d'un détecteur de mouvement. Il est facile à utiliser avec un bouton de commutation entre les modes haut/moyen. Cette lampe frontale a une bande élastique confortable qui s'adapte facilement à n'importe quelle tête.

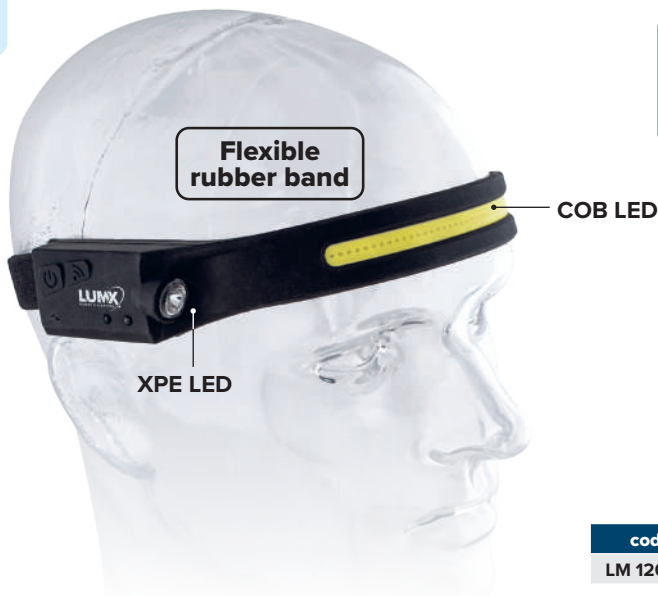

5 modes

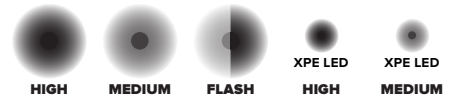

		Lm	Beam Angle	Battery Life
HEADLIGHT	HIGH	350 Lm	200 m	± 2,5 u/h
	MED	150 Lm	20 m	± 5 u/h
	FLASH	N/A	N/A	± 8 u/h
XPE LED	HIGH	150 Lm	200 m	± 4 u/h
	MEDIUM	60 Lm	100 m	± 8 u/h

code	i	Dimensions	Lm
LM 12005	6500K	280 x 35 x 20 mm	350

(((**SENSOR**)))



Anti-slip strips
Antislipstrips
Bandes antidérapantes



CE

250
Lumen

LUMILEDS

The Brighter Choice

IP X4

TCT-250S

3 x AAA
DURACELL
(incl.)

SHOCK
RESISTANT
2m

This head lamp is tiltable, robust and compact. It has 8 operating modes. The light sensor mode is useful when you move from an illuminated environment to a less illuminated environment because the lamp automatically adjusts the intensity of the light. The motion sensor mode gives you the option to turn the light on or off without touching any buttons.

Deze hoofdlamp is kantelbaar, robuust en compact. Het heeft 8 gebruiksstanden. De lichtsensormodus is handig wanneer u zich verplaatst van een verlichte omgeving naar een minder verlichte omgeving omdat de lamp automatisch de intensiteit van het licht aanpast. De bewegingssensormodus geeft u de mogelijkheid om het licht aan of uit te schakelen zonder knoppen aan te raken.

Cette lampe frontale est inclinable, robuste et compacte. Elle comporte 8 modes d'utilisation. Le mode capteur de lumière est pratique lorsque vous passez d'un environnement plus éclairé à un environnement moins éclairé car la lampe modifie d'elle-même l'intensité de la lumière. Le mode capteur de mouvement vous donne la possibilité d'activer ou de désactiver l'éclairage en ne touchant aucun bouton.

8 modes

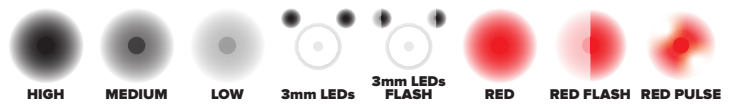

With light sensor
Met lichtsensor
Avec capteur de lumière



With motion sensor
Met bewegingssensor
Avec capteur de mouvement



With pulse mode
Met pulsmodus
Avec mode pulse

		Lm	\angle m	
HEADLIGHT	HIGH	250 Lm	110 m	± 3 u/h
	MED	100 Lm	70 m	± 8 u/h
	LOW	10 Lm	25 m	± 50 u/h
	3mm LEDs	15 Lm	10 m	± 24 u/h
	3mm LEDs FLASH	N/A	N/A	± 115 u/h
REAR LIGHT	RED	N/A	N/A	± 9 u/h
	RED FLASH	N/A	N/A	± 81 u/h
	RED PULSE	N/A	N/A	± 27 u/h

code			Lm
LM 12440	6500K	36 x 82 x 37 mm	250



Anti-slip strips
Antislipstrips
Bandes antidérapantes



300
Lumen

LIGHT BY
CREE
LEDs

IP 64

TCT-300

Incl. 3,7 V
2600 mAh
Li-ion

±4
hrs

SHOCK
RESISTANT
2m

USB
rechargeable

Changeable
battery

This head lamp is 45° tiltable, robust and compact. It has 6 operating modes. The exposure focus is adjustable thanks to the rotating wheel that covers the lamp. The lighting system is rechargeable thanks to the USB cable.

Deze hoofdlamp is 45° kantelbaar, robuust en compact. Het heeft 6 gebruiksstanden. De belichtingfocus is instelbaar dankzij het draaibare wiel die de lamp omvat. Het verlichtingssysteem is oplaadbaar dankzij de USB-kabel.

Cette lampe frontale est inclinable à 45°, robuste et compacte. Elle comporte 6 modes d'utilisation. La mise au point de l'éclairage est réglable grâce à la molette qui surmonte la lampe. Le système d'éclairage est rechargeable grâce au câble USB.



LM 12998

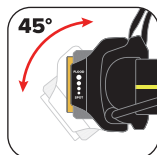

45° tiltable
45° kantelbaar
Inclinaison à 45°

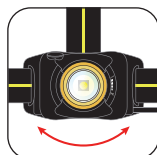

Adjustable focus
Verstelbare focus
Mise au point réglable



With red rear light
Met rood achterlicht
Avec feu arrière rouge

6 modes

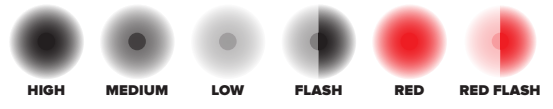

	Lm	Beam Distance (m)	Runtime (hrs)
HIGH	300 Lm	140 m	± 11 u/h
MED	150 Lm	100 m	± 26 u/h
LOW	30 Lm	44 m	± 90 u/h
FLASH	N/A	N/A	± 14 u/h
RED	N/A	N/A	± 40 u/h
RED FLASH	N/A	N/A	± 115 u/h

code	Color Temperature	Dimensions	Lm
LM 12590	7100K - 8300K	79 x 44 x 38 mm	300
Battery / Batterij / Batterie			
LM 12998	3,7 V - 2600 mAh	71 x Ø 19 mm	-



Anti-slip strips
Antislipstrips
Bandes antidérapantes



640
Lumen



TCT-640

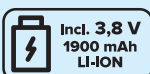

or / of / ou

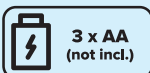

This powerful 640 Lumen headlamp has an ultra-wide illumination angle and is 90° tiltable and 6 user modes. The lighting system has a rear light and is rechargeable thanks to the USB cable.

Deze krachtige hoofdlamp van 640 Lumen heeft een ultrabrede verlichtingshoek en is 90° kantelbaar. Het heeft 6 gebruiksstanden. Het verlichtingssysteem heeft een achterlicht en is oplaadbaar dankzij de USB-kabel.

Cette lampe frontale est inclinable à 90° et possède un angle d'éclairage ultra large. Il dispose de 6 modes d'utilisation. Le système d'éclairage dispose d'un feu arrière et est rechargeable grâce au câble USB.

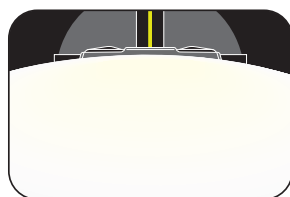

Ultra-wide lighting
Ultrabrede verlichting
Éclairage ultra-large

6 modes

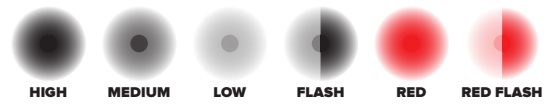

LM 12999

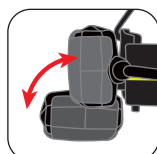

90° tiltable
90° kantelbaar
Inclinaison à 90°



With red rear light
Met rood achterlicht
Avec lumière arrière rouge

	Lm	Beam Angle	Runtime
HIGH	640 Lm	35 m	± 3 u/h
MED	320 Lm	25 m	± 6 u/h
LOW	60 Lm	11 m	± 12 u/h
FLASH	N/A	N/A	± 8 u/h
RED	N/A	N/A	N/A
RED FLASH	N/A	N/A	N/A

code	Color	Dimensions	Lm
LM 12600	6500K - 7100K	125 x 35 x 25 mm	640
Battery / Batterij / Batterie			
LM 12999	3,8 V - 1900 mAh	47 x 45 x 14 mm	-



Electricity
Elektriciteit
Électricité



Aluminium drum
Trommel aluminium
Tambour alu

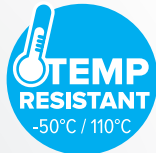

Cable reel XT PREMIUM
Kabelhaspel XT PREMIUM
Enrouleur de câble XT PREMIUM

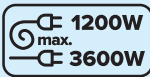
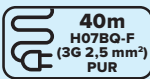

The professional cable reel is appropriate for every building site due to the polyurethane cable. The robust frame of this reel gives the drum extra protection and a longer service life. The drum is made of aluminum, is stainless and gives protection up to IP44. The cable reel is 40 meters long and resistant to oil, extreme temperatures and is shock resistant. A cable guide simplifies the winding and unrolling of the cable.

De professionele kabelhaspel is geschikt op elke werf dankzij de polyurethaan kabel. Het robuuste kader van deze haspel geeft de trommel een extra bescherming en een langere levensduur. De trommel is vervaardigd uit aluminium, is roestvrij en biedt bescherming tot IP44. De kabelhaspel is 40 meter lang en bestend tegen olie, extreme temperaturen en is schokbestendig. Een kabelgeleider vereenvoudigt het op- en uitrollen van de kabel.

Cet enrouleur de câble professionnel convient sur tous les chantiers grâce au câble en polyuréthane. Le cadre robuste de cet enrouleur de câble confère au tambour une protection supplémentaire et une durée de vie plus longue. Le tambour est en aluminium, inoxydable et offre une protection jusqu'à IP44. L'enrouleur de câble mesure 40 mètres de long et résiste à l'huile, aux températures extrêmes et aux chocs. Un guide-câble simplifie l'enroulement et le déroulement du câble.



XT
PREMIUM
PUR
HEAVY DUTY



4 plug sockets
4 stopcontacten
4 prises

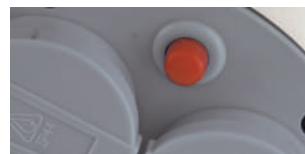

Thermal switch
Thermische schakelaar
Interrupteur thermique



Blockable
Blokkeerbaar
Bloquable

code	⊕⊖	i	
LM 88740	4x (2P+A/2P+T)		40 m

i **Drum Ø 305 mm (40 m)** - ensures that the cable does not protrude out of the drum
Trommel Ø 305 mm (40 m) - zorgt ervoor dat de kabel niet uit de trommel steekt
Tambour Ø 305 mm (40 m) - garantit que le câble ne déborde pas du tambour



Plastic drum
Trommel kunststof
Tambour plastique

Cable reel XT PRO
Kabelhaspel XT PRO
Enrouleur de câble XT PRO

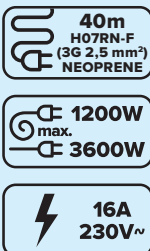

The professional cable reel is appropriate for every building site due to the neoprene cable. The robust frame of this reel gives the drum extra protection and a longer service life. The drum is made of plastic and gives protection up to IP44. The cable reel is 40 meters long and resistant to extreme temperatures and is shock resistant. A cable guide simplifies the winding and unrolling of the cable.

De professionele kabelhaspel is geschikt op elke werf dankzij de neopreen kabel. Het robuuste kader van deze haspel geeft de trommel een extra bescherming en een langere levensduur. De trommel is vervaardigd uit kunststof en biedt bescherming tot IP44. De kabelhaspel is 40 meter lang en bestend tegen extreme temperaturen en is schokbestendig. Een kabelgeleider vereenvoudigt het op- en uitrollen van de kabel.

Cet enrouleur de câble professionnel convient sur tous les chantiers grâce au câble en néoprène. Le cadre robuste de cet enrouleur de câble confère au tambour une protection supplémentaire et une durée de vie plus longue. Le tambour est en plastique et offre une protection jusqu'à IP44. L'enrouleur de câble mesure 40 mètres de long et résiste aux températures extrêmes et aux chocs. Un guide-câble simplifie l'enroulement et le déroulement du câble.



4x
BE/FR

4x
DE/NL

XT
PRO
NEOPRENE
HEAVY DUTY



4 plug sockets
4 stopcontacten
4 prises



Thermal switch
Thermische schakelaar
Interrupteur thermique



Blockable
Blokkeerbaar
Bloquable

code	☺	i	📏
LM 87240	4x (2P+A/2P+T)	🇧🇪 🇫🇷	40 m
LM 87278	4x (2P+A/2P+T)	🇩🇪 🇳🇱	40 m

i Drum Ø 305 mm (40 m) - ensures that the cable does not protrude out of the drum
 Trommel Ø 305 mm (40 m) - zorgt ervoor dat de kabel niet uit de trommel steekt
 Tambour Ø 305 mm (40 m) - garantit que le câble ne déborde pas du tambour



CE



Plastic drum
Trommel kunststof
Tambour plastique

Cable reel **PRO**
Kabelhaspel **PRO**
Enrouleur de câble **PRO**

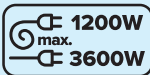
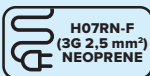

The professional cable reel is appropriate for every building site due to the neoprene cable. This reel is made out of plastic. It suffices to IP44. The soft-grip handle makes sure it's comfortable for the user. The cable reel is available in 25 and 40 meters.

De professionele kabelhaspel is geschikt op elke werf dankzij de neopreen kabel. De trommel is gemaakt uit kunststof. Het biedt bescherming tot IP44. Het soft-grip handvat zorgt ervoor dat het comfortabel in de hand ligt. De kabelhaspel is beschikbaar in 25 en 40 meter.

Cet enrouleur de câble professionnel est adapté au travail sur chantier grâce à son câble en néoprène. Le tambour est conçu en plastique. Il offre une protection IP44. La poignée en Soft-Grip assure le confort d'utilisation. L'enrouleur de câble est disponible en 25 et 40 mètres.



PRO
NEOPRENE
HEAVY DUTY



4 plug sockets
4 stopcontacten
4 prises



Thermal switch
Thermische schakelaar
Interrupteur thermique



Cable conductor
Kabelgeleider
Guide de câble

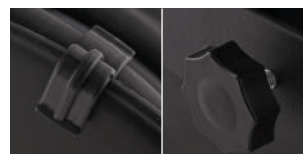

Blockable
Blokkeerbaar
Bloquable

code	⊕	i	📏
LM 85025	4x (2P+A/2P+T)	🇧🇪 🇫🇷	25 m
LM 85140	4x (2P+A/2P+T)	🇧🇪 🇫🇷	40 m



Plastic drum
Trommel kunststof
Tambour plastique



Cable reel **PRO** with 3-way connector
Kabelhaspel **PRO** met driewegskoppelstekker
Enrouleur de câble **PRO** avec fiche femelle triple

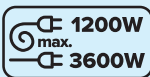
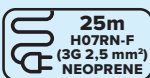

The three-way cable reel is appropriate for every building site due to the neoprene cable. This reel is made out of plastic. It suffices to IP44. The soft-grip handle makes sure it's comfortable for the user. The cable reel is available in 25 meters.

De driewegs kabelhaspel is geschikt op elke werf dankzij de neopreen kabel. De trommel is gemaakt uit kunststof. Het biedt bescherming tot IP44. Het soft-grip handvat zorgt ervoor dat het comfortabel in de hand ligt. De kabelhaspel is beschikbaar in 25 meter.

L'enrouleur de câble à 3 entrées est adapté pour le travail sur chantier grâce à son câble en néoprène. Le tambour est en plastique. Il offre une protection IP44. La poignée Soft-Grip assure une confortabilité. Cet enrouleur est disponible en une seule version de 25 mètres.



Three-way power block
Driewegs contactblok
Multiprise à 3 entrées



Thermal switch
Thermische schakelaar
Interrupteur thermique



Cable conductor
Kabelgeleider
Guide de câble



Blockable
Blokkeerbaar
Bloquable



PRO
3 - WAY
NEOPRENE
HEAVY DUTY

code	⊕⊖	i	📏
LM 85728	3x (2P+A)/2P+T	🇧🇪 🇫🇷	25 m



Plastic drum
Trommel kunststof
Tambour plastique



CE



Cable reel **XT-PRO** No-turn
Kabelhaspel **XT-PRO** No-turn
Enrouleur de câble **XT-PRO** No-turn

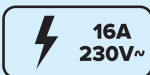
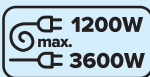
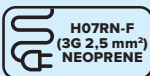

This cable reel is suitable for every yard and every profession. The metal frame offers extra stability and extra protection of the drum. Thanks to the four sockets, with hinged lids, you can connect up to 3600 watts to the cable reel.

Deze kabelhaspel is geschikt voor elke werf en elk vakgebied. Het metalen frame biedt extra stabiliteit en extra bescherming van de trommel. Dankzij de vier stopcontacten, met klapdeksel, kan u tot maar liefst 3600 Watt aansluiten op de kabelhaspel.

Cet enrouleur de câble convient à tous les chantiers et à toutes les professions. Le cadre en métal offre une stabilité supplémentaire et une protection supplémentaire du tambour. Grâce aux quatre prises, avec un couvercle à charnière, vous pouvez connecter jusqu'à 3600 Watt à l'enrouleur de câble.



XT
PRO
NEOPRENE
HEAVY DUTY

code	⊕⊖	i	
LM 87635	4x (2P+A/2P+T)		35 m



4 plug sockets
4 stopcontacten
4 prises



Thermal switch
Thermische schakelaar
Interrupteur thermique

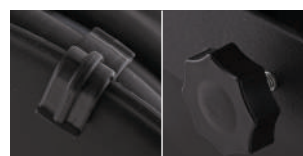

Blockable
Blokkeerbaar
Bloquable



Plastic drum
Trommel kunststof
Tambour plastique

CE

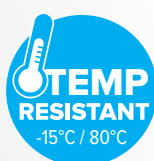

Standard cable reel BS HOME
Standaard kabelhaspel BS HOME
Enrouleur de câble standard BS HOME

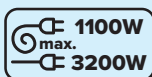
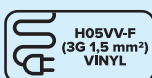

The standard cable reel is appropriate for use at home or in the garden. This reel is made out of plastic. It suffices to IP20. The soft-grip handle makes sure it's comfortable for the user. The cable reel is available in 25 and 50 meters.

De standaard kabelhaspel is de beste keuze voor huis- en tuingebruik. De trommel is gemaakt uit kunststof. Het biedt bescherming tot IP20. Het soft-grip handvat zorgt ervoor dat het comfortabel in de hand ligt. De kabelhaspel is beschikbaar in 25 en 50 meter.

L'enrouleur de câble est le meilleur choix pour une utilisation domestique. Le tambour est conçu en plastique. Il offre une protection IP20. La poignée en Soft-Grip assure une certaine confortabilité. L'enrouleur de câble est disponible en modèle 25 et 50 mètres.



BS
HOME
VINYL



4 plug sockets
4 stopcontacten
4 prises



Thermal switch
Thermische schakelaar
Interrupteur thermique



Blockable
Blokkeerbaar
Bloquable

code	⊕	i	📏
LM 80025	4x (2P+A/2P+T)	🇧🇪 🇫🇷	25 m
LM 80050	4x (2P+A/2P+T)	🇧🇪 🇫🇷	50 m



CE



Power block with hinged lid
Contactblok met klapdeksel
Prise à clapet



With hinged lid
Met klapdeksel
Avec clapet

2P+A
2P+T
230V - 50 Hz

code	
LM 48200	double / dubbel / double



There are two plug sockets in this power block. The hinged lid protects the plug socket against dust and moisture.

Er zijn twee stopcontacten voorzien in deze contactblok. Het klapdeksel beschermt de stopcontacten tegen stof en vocht.

2 prises sont prévues sur cette multiprise. Les clapets protègent la prise de la poussière et de l'humidité.



With hinged lid
Met klapdeksel
Avec clapet

2P+A
2P+T
230V - 50 Hz

code	
LM 48300	triple / 3-voudig / triple



There are three plug sockets in this power block. The hinged lid protects the plug socket against dust and moisture.

Er zijn drie stopcontacten voorzien in deze contactblok. Het klapdeksel beschermt de stopcontacten tegen stof en vocht.

3 prises sont prévues sur cette multiprise. Les clapets protègent la prise de la poussière et de l'humidité.



CE



Plug and plug socket
Stekker en stopcontact
Prise mâle et femelle

2P+A
2P+T
230V - 50 Hz

code	i
LM 48521	rubber / caoutchouc



The plug is IP44 and can be used for every connection cable. It is made out of rubber.

De stekker is IP44 en kan gebruikt worden op elke aansluitkabel. En is vervaardigd uit rubber.

La fiche est IP44 et peut être utilisée sur n'importe que câble. La fiche est composée de caoutchouc.



With hinged lid
Met klapdeksel
Avec clapet

2P+A
2P+T
230V - 50 Hz

code	i
LM 48411	rubber / caoutchouc



This plug socket is made of rubber and has a hinged lid.

Dit stopcontact bestaat uit rubber en beschikt over een klapdeksel.

Cette prise est conçue en caoutchouc et est munie d'un clapet.

DUAL SYSTEM



CE



2X faster assembling
sneller monteren
plus vite monté

Plug and plug socket **DUAL SYSTEM**
Stekker en stopcontact **DUAL SYSTEM**
Prise mâle et femelle **DUAL SYSTEM**



2P+A
2P+T
230V - 50 Hz

code	i
LM 48585	Dual System

This plug has Dual System, assembling goes two times faster.

Deze stekker beschikt over het Dual System, zodat het monteren twee keer zo snel gaat.

Cette fiche est pourvue d'un Dual System, de sorte que le montage soit 2x plus rapide.



With hinged lid
Met klapdeksel
Avec clapet

2P+A
2P+T
230V - 50 Hz

code	i
LM 48455	Dual System



Assembling this rubber plug socket goes two times faster.

Het monteren van dit rubberen stopcontact verloopt twee keer zo snel.

Le montage de cette fiche en caoutchouc est 2 x plus rapide qu'un modèle standard.

NEW

CE



Extension cable in neoprene
Verlengkabel in neopreen
Rallonge en néoprène

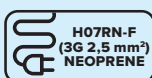

This neoprene extension cable is very strong, causing it is appropriate for intensive use on a building site. Thanks to the hinged, rubber lid, no dust will enter the plug socket.

Deze neopreen verlengkabel is heel stevig waardoor het geschikt is voor intensief gebruik op de werf. En dankzij het rubberen klapdeksel komt er geen stof in het stopcontact.

La rallonge en néoprène est très résistante et est adaptée à une utilisation intensive sur chantier. Grâce au clapet en caoutchouc, aucune poussière n'entre en contact avec la prise.



With hinged lid
Met klapdeksel
Avec clapet

code	
LM 40605	5 m
LM 40625	25 m





CE



Extension cable in vinyl
Verlengkabel in vinyl
Rallonge en vinyl



This vinyl extension cable is the best choice for use at home or in the garden. The hinged lid protects the plug socket against dust and moisture. It's available in two lengths: 15 and 25 meters.

Deze vinyl verlengkabel is het best geschikt voor huis- en tuingebruik. Het klapdeksel beschermt het stopcontact tegen stof en vocht. Het is te verkrijgen in verschillende lengtes: 15 en 25 meter.

L'enrouleur de câble est le meilleur choix pour une utilisation domestique. Le clapet protège la prise de la poussière et de l'humidité. L'enrouleur est disponible en plusieurs longueurs: 15 et 25 mètres.



With hinged lid
Met klapdeksel
Avec clapet

code	
LM 40515	15 m
LM 40526	25 m



CE



Extension cable in neoprene
Verlengkabel in neopreen
Rallonge en néoprène

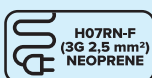

This neoprene extension cable is very strong, causing it is appropriate for intensive use on a building site. Thanks to the hinged lid, no dust will enter the plug socket.

Deze neopreen verlengkabel is heel stevig waardoor het geschikt is voor intensief gebruik op de werf. En dankzij het klapdeksel komt er geen stof in het stopcontact.

La rallonge en néoprène est très résistante et est adaptée à une utilisation intensive sur chantier. Grâce au clapet, aucune poussière n'entre en contact avec la prise.



With hinged lid
Met klapdeksel
Avec clapet



code	
LM 40745	5 m
LM 40750	10 m
LM 40755	15 m
LM 40765	25 m
LM 40770	40 m

CE



Machine connection cable
Machine-aansluitkabel
Câble de raccordement

230V - 16A

This neoprene machine connection cable with three conductors can be used to connect almost all machines.

Deze neopreen machine aansluitkabel met drie geleiders kan gebruikt worden om de meeste machines aan te sluiten.

Ce câble de raccordement pour machine à 3 conducteurs peut être utilisé sur la plupart des machines.



3 conductors
3 geleiders
3 conducteurs



code	
LM 40435	5 m

This machine connection cable is made from qualitatively neoprene, it has a phase and neutral conductor.

Deze aansluitkabel bestaat uit het kwalitatieve neopreen, er is een fase en nulleider voorzien.

Ce câble de raccordement est conçu avec du néoprène de qualité, il y a 2 conducteurs dont 1 positif et 1 négatif.



2 conductors
2 geleiders
2 conducteurs



code	
LM 40425	5 m



code	
LM 40443	3 m
LM 40445	5 m



code	
LM 40453	3 m



code	
LM 40455	5 m



CE



Power strip - 4 sockets
Verdeelblok - 4 stopcontacten
Bloc multiprises - 4 prises

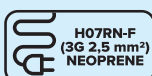

EN 60309

This power strip is very robust and can handle some impact, perfect for every building site! This power strip is also available without cable. There are two holes, so the power strip can be attached to a wall.

Deze robuuste stekkerdoos kan zeker tegen een stootje, ideaal voor de werf dus. De stekkerdoos is ook verkrijgbaar zonder kabel. Er zijn twee gaatjes voorzien, zodat de stekkerdoos kan worden bevestigd aan een muur.

Cette robuste multiprise est résistante aux chocs et donc idéale pour le travail sur chantier. Ce produit est également disponible sans câble. Il est muni de 2 trous, afin de pouvoir le fixer au mur ou tout autre support.



With switch
Met schakelaar
Avec interrupteur



With hinged lid
Met klapdeksel
Avec clapet



250V - 16A

code	⊕	i
LM 41200	4-fold / 4-voudig / quadruple	block
LM 41203	4-fold / 4-voudig / quadruple	3 m cable / kabel / câble
LM 41210	4-fold / 4-voudig / quadruple	10 m cable / kabel / câble



CE



Power strip - 2/3/4/6 sockets
Stekkerdoos - 2/3/4/6 stopcontacten
Multiprise - 2/3/4/6 prises



The power strip is available with 2, 3, 4 and 6 plug sockets. It is a must-have at home or when working in the garden!

De stekkerdoos is beschikbaar met 2, 3, 4 en 6 stopcontacten. Het komt steeds van pas! Perfect voor gebruik thuis of in de tuin.

Cette multiprise est disponible avec 2, 3, 4 et 6 prises. Les prises sont toujours les bienvenues! Parfait pour une utilisation domestique.



250V - 50 Hz

code	⊕	ⓘ
LM 40800	2-fold / 2-voudig / double	block
LM 40803	3-fold / 3-voudig / triple	1,5 m cable / kabel / câble
LM 40814	4-fold / 4-voudig / quadruple	3 m cable / kabel / câble
LM 40826	6-fold / 6-voudig / sextuple	5 m cable / kabel / câble
LM 40913	3-fold / 3-voudig / triple	1,5 m cable / kabel / câble



With switch
Met schakelaar
Avec interrupteur

CE



Power block - 3 sockets
Contactblok - 3 stopcontacten
Multiprise - 3 prises

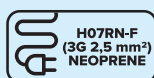

This power block with three plug sockets is available with a cable of 10 and 25 meters. The hinged lid protects the plug socket against dust and moisture.

Deze contactblok met drie stopcontacten is beschikbaar met een kabel van 10 en 25 meter. Het klapdeksel beschermt het stopcontact tegen stof en vocht.

Cette multiprise avec 3 prises est disponibles avec un câble de 10 et 25 mètres. Le clapet protège la prise de la poussière et de l'humidité.



2P+A
2P+T

230V - 50 Hz

code	↺	ℹ
LM 48310	3-fold / 3-voudig / triple	10 m cable / kabel / câble
LM 48325	3-fold / 3-voudig / triple	25 m cable / kabel / câble



With hinged lid
Met klapdeksel
Avec clapet

CE



Threeway couple plug
Driewegskoppelstekker
Multiprise à 3 entrées



The threeway couple plug is dust-proof thanks to the hinged lids. This power block with three plug sockets is available with and without cable.

De driewegkoppelstekker is stofvrij dankzij de klapdeksels. Deze contactblok met drie stopcontacten is beschikbaar met of zonder kabel.

Cette multiprise à 3 entrées est protégée de la poussière grâce aux clapets de fermeture. Cette multiprise à 3 entrées est disponible avec ou sans câble.



With hinged lid
Met klapdeksel
Avec clapet

16A 250V_~

Max. 3680W

code	ⓘ
NI 243300	block
NI 243303	0,3 m cable / kabel / câble
NI 243305	5 m cable / kabel / câble
NI 243310	10 m cable / kabel / câble
NI 243325	25 m cable / kabel / câble



With or without cable
Met of zonder kabel
Avec ou sans câble



CE



Neoprene extension cables
Neopreen verlengkabels
Allonges néoprène

EN 60309



2P+A
2P+T
250V - 16A

code	i
LM 44102	2 m cable / kabel / câble



3P+N+A
3P+N+T
400V - 16A

code	i
LM 44110	10 m cable / kabel / câble
LM 44125	25 m cable / kabel / câble



3P+N+A
3P+N+T
400V - 32A

code	i
LM 44345	25 m cable / kabel / câble



3P+N+A
3P+N+T
400V - 32A

code	i
LM 44566	25 m cable / kabe / câble



3P+N+A
3P+N+T
400V - 64A

code	i
LM 44580	25 m cable / kabel / câble

CE



CEE plug (M) - couple plug (F)
CEE stekkers (M) - koppelstekkers (V)
Fiches CEE male (M) - femelle (F)

EN 60309



2P+A
2P+T
250V - 16A

code	i
LM 44730	male / man / male
LM 44835	female / vrouw / femelle



3P+N+A
3P+N+T
400V - 16A

code	i
LM 44751	male / man / male
LM 44861	female / vrouw / femelle



3P+N+A
3P+N+T
400V - 32A

code	i
LM 44753	male / man / male
LM 44863	female / vrouw / femelle



3P+N+A
3P+N+T
400V - 63A

code	i
LM 44755	male / man / male
LM 44865	female / vrouw / femelle



3P+N+A
3P+N+T
400V - 16A

code	i
LM 44646	male / man / male
LM 44662	female / vrouw / femelle



3P+N+A
3P+N+T
400V - 16A

code	i
LM 44616	male / man / male
LM 44632	female / vrouw / femelle



CE



CEE distribution box
CEE verdeelkast
Coffret de distribution CEE

ISO 9001

This distribution box has three outputs. It has a compact shape and is made from shockproof polyamide. In addition it is splash-proof.

Deze verdeelkast heeft 3 uitvoeren. De verdeelkast heeft een compacte vorm gemaakt van schokbestendige polyamide. Het is bovendien spatbestendig.

Ce coffret de distribution est muni de 3 sorties. Celui-ci est de forme compact en polyamide résistant aux chocs. Il est également résistant aux éclaboussures.



code **LM 46101** 240 x 100 x 80 mm



code **LM 46105** 240 x 100 x 80 mm

	LM 46101	LM 46105
Cable type / Kabeltype / Type de câble	-	H07RN-F / 5G 2,5 mm ²
Cable length / Kabellengte / Longueur de câble	-	1,5 m
Input / Invoer / Entrée	1 x CEE 16A - 5P - 400V	1 x CEE 16A - 5P - 400V
Output / Uitvoer / Sortie	1 x CEE 16A - 5P - 400V 2 x 16A - 230V	1 x CEE 16A - 5P - 400V 2 x 16A - 230V
IP-classification / IP-classificatie / Classification IP	IP44	IP44
Dimensions / Afmetingen / Dimensions	240 x 100 x 80 mm	240 x 100 x 80 mm
Plugs / Stekkers / Prises	 F B	 F B





CE



CEE distribution box
CEE verdeelkast
Coffret de distribution CEE

ISO 9001

This distribution box has three outputs. It has a compact shape and is made from shockproof polyamide. In addition it is splash-proof.

Deze verdeelkast heeft 3 uitvoeren. De verdeelkast heeft een compacte vorm gemaakt van schokbestendige polyamide. Het is bovendien spatbestendig.

Ce coffret de distribution est muni de 3 sorties. Celui-ci est de forme compact en polyamide résistant aux chocs. Il est également résistant aux éclaboussures.



code	
LM 46120	200 x 170 x 80 mm



code	
LM 46122	240 x 170 x 80 mm



	LM 46120	LM 46122
Cable type / Kabeltype / Type de câble	-	H07RN-F / 5G 2,5 mm ²
Cable length / Kabellengte / Longueur de câble	-	1,5 m
Input / Invoer / Entrée	1 x CEE 16A - 5P - 400V	1 x CEE 16A - 5P - 400V
Output / Uitvoer / Sortie	3 x CEE 16A - 5P - 400V	3 x CEE 16A - 5P - 400V
IP-classification / IP-classificatie / Classification IP	IP44	IP44
Dimensions / Afmetingen / Dimensions	200 x 170 x 80 mm	240 x 170 x 80 mm
Plugs / stekkers / prises	Universal Universeel Universel	Universal Universeel Universel

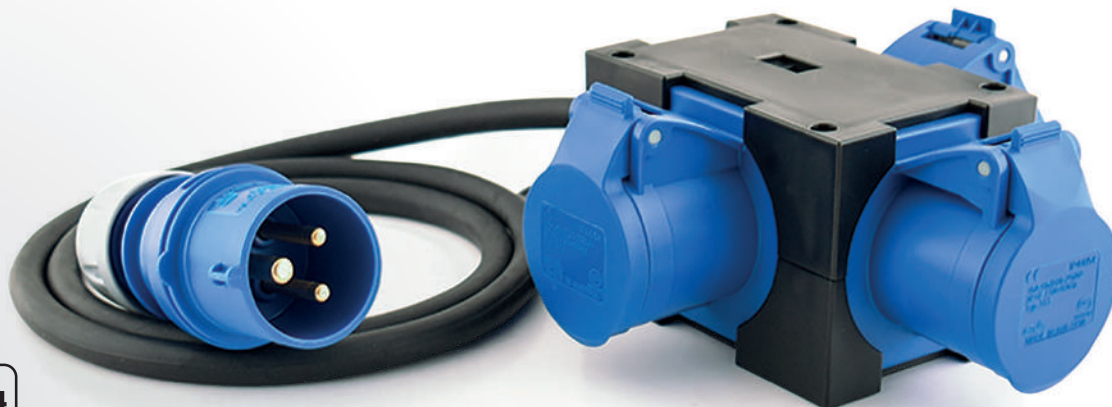

CE



CEE distribution box
CEE verdeelkast
Coffret de distribution CEE

ISO 9001

This distribution box has three outputs. It has a compact shape and is made from shockproof polyamide. In addition it is splash-proof.

Deze verdeelkast heeft 3 uitvoeren. De verdeelkast heeft een compacte vorm gemaakt van schokbestendige polyamide. Het is bovendien spatbestendig.

Ce coffret de distribution est muni de 3 sorties. Celui-ci est de forme compact en polyamide résistant aux chocs. Il est également résistant aux éclaboussures.



code	
LM 46134	240 x 170 x 80 mm

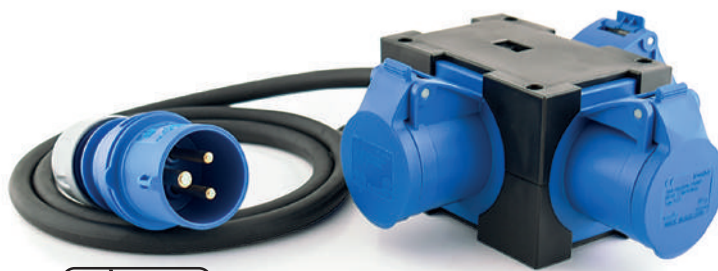

	H07RN-F (3G 2,5 mm ²) NEOPRENE	code	
		LM 46138	240 x 170 x 80 mm

	LM 46134	LM 46138
Cable type / Kabeltype / Type de câble	-	H07RN-F / 3G 2,5 mm ²
Cable length / Kabellengte / Longueur de câble	-	1,5 m
Input / Invoer / Entrée	1 x CEE 16A - 3P - 230V	1 x CEE 16A - 3P - 230V
Output / Uitvoer / Sortie	3 x CEE 16A - 3P - 230V	3 x CEE 16A - 3P - 230V
IP-classification / IP-classificatie / Classification IP	IP44	IP44
Dimensions / Afmetingen / Dimensions	240 x 170 x 80 mm	240 x 170 x 80 mm
Plugs / Stekkers / Prises	Universal Universeel Universel	Universal Universeel Universel



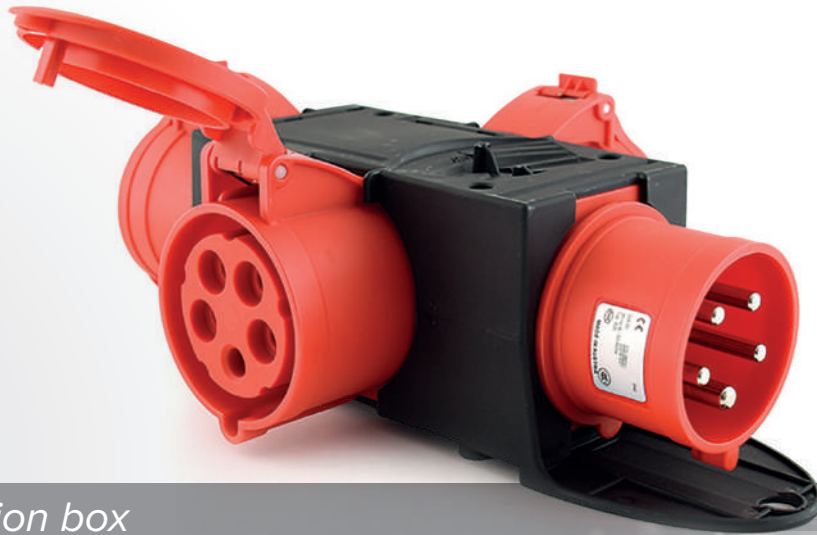

CE



CEE distribution box
CEE verdeelkast
Coffret de distribution CEE

ISO 9001

This distribution box has three outputs. It has a compact shape and is made from shockproof polyamide. In addition it is splash-proof.

Deze verdeelkast heeft 3 uitvoeren. De verdeelkast heeft een compacte vorm gemaakt van schokbestendige polyamide. Het is bovendien spatbestendig.



Ce coffret de distribution est muni de 3 sorties. Celui-ci est de forme compact en polyamide résistant aux chocs. Il est également résistant aux éclaboussures.

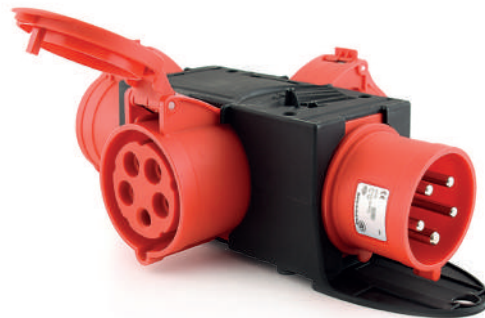

code 
LM 46478 200 x 100 x 80 mm



code 
LM 46413 295 x 190 x 100 mm

	LM 46478	LM 46413
Input / Invoer / Entrée	1 x CEE 16A - 5P - 400V	1 x CEE 32A - 5P - 400V
Output / Uitvoer / Sortie	3 x 16A - 250V	3 x CEE 32A - 5P - 400V
IP-classification / IP-classificatie / Classification IP	IP44	IP44
Dimensions / Afmetingen / Dimensions	200 x 100 x 80 mm	295 x 190 x 100 mm
Plugs / Stekkers / Prises	  F B	Universal Universeel Universel





CE



CEE distribution box
CEE verdeelkast
Coffret de distribution CEE

EN 61439

This distribution box has six outputs. It has a compact shape and is made from shockproof polyamide. In addition it is splash-proof. The distribution box is completely wired and is ready to be used! The carrying handle makes it easy to transport the box.

Deze verdeelkast heeft 6 uitvoeren. De verdeelkast is handig en robuust gemaakt van schokbestendige polyamide. Het is bovendien spatbestendig. En dankzij de draagbeugel, kan de verdeelkast makkelijk worden verplaatst.

Ce coffret de distribution est muni de 6 sorties. Celui-ci est de forme compact en polyamide résistant aux chocs. Il est également résistant aux éclaboussures. Grâce à sa poignée de transport, ce coffret peut être facilement déplacé.

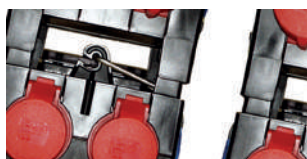

Stackable
Stapelbaar
Empilable



code	
LM 47110	200 x 197 x 197 mm

	LM 47110
Input / Invoer / Entrée	1 x CEE 16A - 5P - 400V
Output / Uitvoer / Sortie	2 x CEE 16A - 400V 4 x 16A - 250V
IP-classification / IP-classificatie / Classification IP	IP44
Dimensions / Afmetingen / Dimensions	200 x 197 x 197 mm
Plugs / Stekkers / Prises	 F B





CE

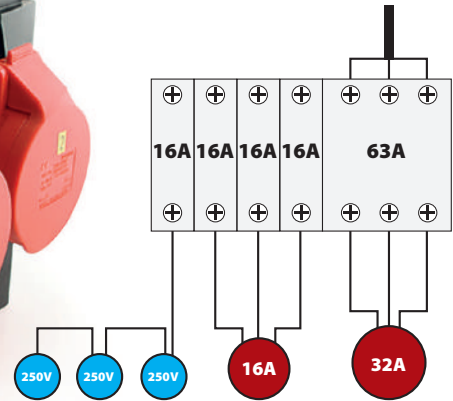

CEE distribution box
CEE verdeelkast
Coffret de distribution CEE

EN 61439

This distribution box has five outputs. It has a compact shape and is made from shockproof polyamide. In addition it is splash-proof. The carrying handle makes it easy to transport the box. The distribution box is completely wired and is ready to be used! There's also a storage system for the cable.

Deze verdeelkast heeft 5 uitvoeren. De verdeelkast is handig en robuust gemaakt van schokbestendige polyamide. Het is bovendien spatbestendig. En dankzij de draagbeugel, kan de verdeelkast makkelijk worden verplaatst. De verdeelkast is klaar bekabeld en is dus meteen klaar voor aansluiting. Er is ook een opbergsysteem voorzien voor de aansluitkabel.

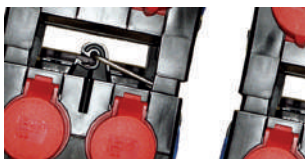

Ce coffret de distribution est muni de 6 sorties. Celui-ci est de forme compact en polyamide résistant aux chocs. Il est également résistant aux éclaboussures. Grâce à sa poignée de transport, ce coffret peut être facilement déplacé. Le coffret est câblé et est donc prêt à être raccordé.



Stackable
Stapelbaar
Empilable



With fuse
Met zekering
Avec fusible

	LM 47117
Cable type / Kabeltype / Type de câble	H07RN-F / 5G 4 mm ²
Cable length / Kabellengte / Longueur de câble	2 m
Input / Invoer / Entrée	1 x CEE 32A - 5P - 400V
Output / Uitvoer / Sortie	1 x CEE 32A + 1 x 16A - 400V 3 x 16A - 250V
Fuse / Zekering / Fusible	63A
IP-classification / IP-classificatie / Classification IP	IP44
Dimensions / Afmetingen / Dimensions	200 x 197 x 197 mm
Plugs / Stekkers / Prises	  F B



code	
LM 47117	200 x 197 x 197 mm



CE



*Distribution box - Electric site box
Verdeelkast - Elektrische werfkast
Coffret de distribution électrique*

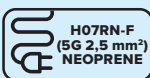

This distribution box has 6 outputs. It is handy and robust made of shock-resistant polyamide. It is also splash resistant. Thanks to the handle, the distribution box can be easily moved. The cabinet is delivered fully wired and ready to use.

Deze verdeelkast heeft 6 uitgangen. Hij is handig en robuust gemaakt van schokbestendige polyamide. Hij is bovendien spatbestendig. Dankzij het handvat kan de verdeelkast makkelijk worden verplaatst. De kast wordt volledig bekabeld geleverd en is klaar om in gebruik te worden genomen.

Ce boîtier de distribution dispose de 6 sorties. Il est maniable et robuste en polyamide résistant aux chocs. Il est également résistant aux éclaboussures. Grâce à la poignée, la boîte de distribution peut être facilement déplacée. L'armoire est livrée entièrement câblée et prête à l'emploi.



	LM 47930	LM 47923
Kabel type / Type de câble	H07RN-F / 5G 2,5 mm ²	H07RN-F / 5G 2,5 mm ²
Kabellengte / Longueur de câble	1,5 m	1,5 m
Max. Watt	6400W	6400W
Min. Watt	960W	960W
Invoer / Entrée	CEE 16A - 5P	CEE 16A - 5P
Uitvoer / Sortie	2 x 400V (16A) 4 x 230V (FR/BE)	2 x 400V (16A) 4 x 230V (SCHUKO)
IP-classificatie / Classification IP	IP44	IP44
Afmetingen / Dimensions	260 x 210 x 180 mm	255 x 250 x 180 mm
Stekkers / Prises	F B	D L

code	
LM 47930	260 x 210 x 180 mm
LM 47923	255 x 250 x 180 mm

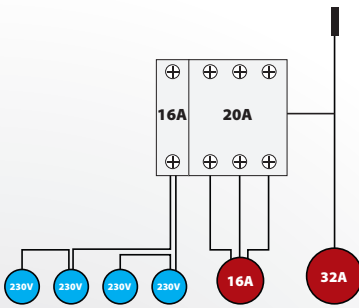

CE



Electric site box with fuse
Elektrische werfkast met zekering
Coffret de distribution électrique avec fusible



This distribution box has 6 outputs. It is handy and robust made of shock-resistant polyamide. It is also splash resistant. Thanks to the handle, the distribution box can be easily moved. The cabinet is delivered fully wired and ready to use.

Deze verdeelkast heeft 6 uitgangen. Hij is handig en robuust gemaakt van schokbestendige polyamide. Hij is bovendien spatbestendig. Dankzij het handvat kan de verdeelkast makkelijk worden verplaatst. De kast wordt volledig bekabeld geleverd en is klaar om in gebruik te worden genomen.

Ce boîtier de distribution dispose de 6 sorties. Il est maniable et robuste en polyamide résistant aux chocs. Il est également résistant aux éclaboussures. Grâce à la poignée, la boîte de distribution peut être facilement déplacée. L'armoire est livrée entièrement câblée et prête à l'emploi.



With fuse
Met zekering
Avec fusible



	LM 47954	LM 47986
Kabel type / Type de câble	H07RN-F / 5G 4 mm ²	H07RN-F / 5G 4 mm ²
Kabellengte / Longueur de câble	4 m	4 m
Max. Watt	12800W	12800W
Min. Watt	-	-
Invoer / Entrée	CEE 32A - 5P	CEE 32A - 5P
Uitvoer / Sortie	400V (1 x 32A - 1 x 16A) 4 x 230V (FR/BE)	400V (1 x 32A - 1 x 16A) 4 x 230V (SCHUKO)
IP-classificatie / Classification IP	IP44	IP44
Afmetingen / Dimensions	350 x 210 x 180 mm	350 x 250 x 180 mm
Stekkers / Prises	F B	D L

code	
LM 47954	350 x 210 x 180 mm
LM 47986	350 x 250 x 180 mm

Accessories
Toebehoren
Accessoires



Min: 1,05 m
Max: 2,75 m

LM 0225E

This tripod can be changed of height: from 1,05 m to 2,75 m. Thanks to the soft-grip handles it's very easy to raise or lower. This tripod is also galvanized, corrosion will be less. This handy tripod can be used for a lot of Lumx lamps.

Dit statief kan worden veranderd van hoogte: van 1,05 m tot 2,75 m. Dankzij de soft-grip handvaten gebeurt dat in 1-2-3. Dit statief is gegalvaniseerd, zo heeft het minder kans op corrosie. Een handig statief dat voor veel Lumx-lampen geschikt is.

La hauteur de ce trépied est ajustable de 1,05m à 2,75m. Grâce aux poignées, la hauteur est ajustée en 2 temps 3 mouvements. Le trépied est galvanisé, ainsi celui-ci à moins de chance de rouiller. Un trépied pratique qui convient à de nombreuses lampes LumX.

Suitable for the following lamps:

Geschikt voor volgende lampen:

Convient pour les lampes suivantes:



GALAXY
LM 32245



GALAXY COMPACT
LM 32232



LED P+100
LM 33600



LED P-80
LM 33580



LED LB-50
LM 37500



LED RS-50
LM 30350



GALAXY RECHARGEABLE
LM 32230



GALAXY R-COMPACT
LM 32228



GALAXY MULTI-BATTERY
LM 30080



LED HP-150
LM 61015



LED HP-200
LM 61020



LED HP-400
LM 61040



LED HP-600
LM 61260



MULTI-BATTERY LED M-SERIES
LM 30065



MULTI-BATTERY LED M-SERIES
LM 30000

code	i
LM 0225E	1,05 m → 2,75 m



max
60 kg

Min: 1,40 m
Max: 3,00 m



Extra security
Extra beveiliging
Broche anti-chute



Cable winding system
Kabelprolsysteem
Système d'enroulage de câble

LM 03305 Heavy Duty Tripod

This robust tripod is adjustable in height from 1.40 m to 3.00 m. The maximum height of 3.00 meters makes it possible to illuminate a larger area without having to light another work light. Thanks to the mounting base, the tripod can be adapted to a large part of the LUMX assortment. The tripod is equipped with a wide opening foot that ensures very good stability when the lighting system is in height.

Dit robuuste statief is in hoogte verstelbaar van 1,40 m tot 3,00 m hoog. De maximale hoogte van 3,00 meter maakt het mogelijk om een groter gebied te verlichten zonder een andere bouwlamp te hoeven aansteken. Dankzij de montagebasis kan het statief worden aangepast aan een groot deel van het LUMX-assortiment. Het statief is uitgerust met een wijd openende voet die zorgt voor een zeer goede stabiliteit wanneer het verlichtingssysteem in de hoogte is.

Ce trépied robuste est réglable en hauteur de 1,40m à 3,00m. La hauteur maximale de 3,00m permet d'éclairer une plus grande superficie sans devoir allumer une autre lampe de chantier. Sa base de fixation rend le trépied adaptable à une grande partie de l'assortiment LUMX. Le trépied est muni de pied à grande ouverture garantissant une très bonne stabilité lorsque le système d'éclairage est en hauteur.

Suitable for the following lamps:

Geschikt voor volgende lampen:

Convient pour les lampes suivantes:

code	
LM 03305	1,40 m → 3,00 m



GALAXY
LM 32245



GALAXY COMPACT
LM 32232



LED HP-150
LM 61015



LED HP-200
LM 61020



LED HP-400
LM 61040



LED HP-600
LM 61260



GALAXY RECHARGEABLE
LM 32230



GALAXY R-COMPACT
LM 32228



GALAXY MULTI-BATTERY
LM 30080



MH-150
LM 60150



MH-400
LM 60400



**MULTI-BATTERY
LED M-SERIES**
LM 30065



**MULTI-BATTERY
LED M-SERIES**
LM 30000



www.lumx.be

DEALER

LUMX
POWER & LIGHTING

United brands of PROF-PRAXIS NV/SA
Scheibekstraat 25-29 - 1540 Herne - Belgium